

U-Sliding Nut

without cylinder head screw

GU 0405

EAN Code: 4013339115907
Smallest packaging unit: 50 pcs.

the photorealistic images are to be considered as reference images

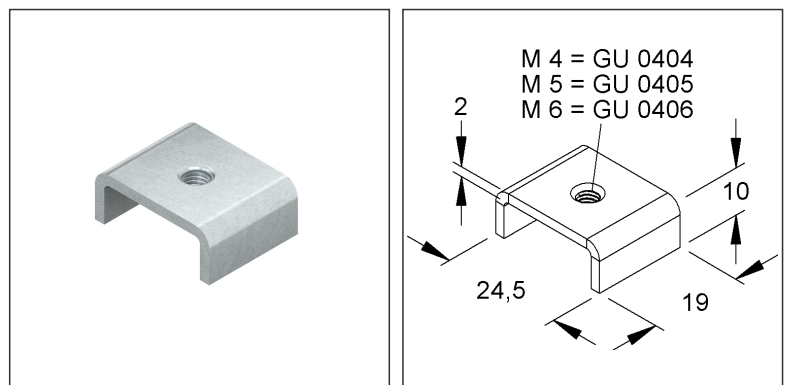

Article Description

U-sliding nut without cylinder head screw, thread M5, H=10 mm, W=19 mm, steel, electro galvanised ISO 4042, thick-film passivated

Additional Price Information

Article group	N09
quantity unit	pcs.

Weight

Weight per quantity unit	12 g / pcs.
Weight in kg per 100	1,15 kg / 100pcs.

Technical Datasheet

Screws and nuts

GU 0405

the photorealistic images are to be considered as reference images

Physical Article Dimensions

Height	10.00 mm
Width	24.50 mm
Depth/length	19.00 mm

Packing Dimension

50 pieces = 1		✓ VP1-smallest packaging unit (PU)		✓ VP1-preferred PU	
Lenght	140.00 mm	Width	80.00 mm	Height	30.00 mm
Gross weight	0,59 kg	Volume	0,000 m ³		
Min. quantity	50.00 pcs.	Max. Quantity	50.00 pcs.		

200 pieces = 1					
Lenght	120.00 mm	Width	120.00 mm	Height	100.00 mm
Gross weight	2,42 kg	Volume	0,001 m ³		
Min. Quantity	200.00 pcs.	Max. Quantity	200.00 pcs.		

20000 pieces = 1					
Lenght	750 mm	Width	750 mm	Height	730 mm
Gross weight	282 kg	Volume	0,411 m ³		
Min. Quantity	20.000.00 pcs.	Max. Quantity	20.000.00 pcs.		

Tender Text

U-sliding nut, without cylinder head screw, for fastening in C-profiles, U-sliding nut can only be inserted from the end of the profile.
Used for : C-profiles 2970 and 2971 with 16 mm slot width
Dimensions (approx. dimensions)
Length L x width W : 24.5 x 19 mm
Height H : 10 mm
Thread : M 5
Material : steel, electro galvanised according to DIN EN ISO 4042, thick-film passivated
NIEDAX Model No. : GU 0405
EP Material_____ EP Wage_____
Unit price/piece

Safety & Environment

REACH Date	25.06.2025
REACH Info	Conformable
RoHS Info	Conformable

Origin & International Trade

Country of origin	DE
Customs tariff number	73181692