

GRP-Cable Tray

pressed, with unperforated side rails, without bottom perforation, with moulded connector, with transverse bottom reinforcements (5 mm)

KK 80.600

EAN Code: 4013339952137

Smallest packaging unit: 3 m

quantity unit: m M

the photorealistic images are to be considered as reference images

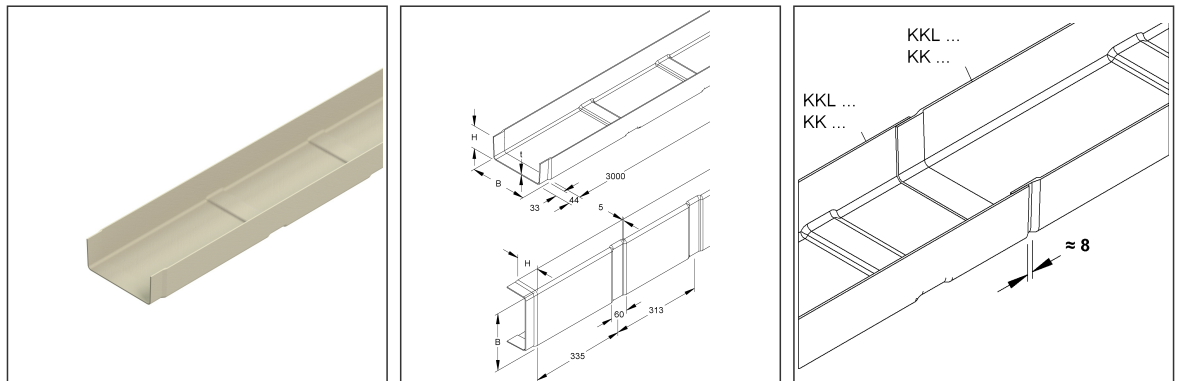

Article Description

GRP-cable tray, 80x600x3000 mm, with connector, unperforated, Polyester glasfaserverstärkt, gepresst, RAL 7032, kieselgrau

Additional Price Information

Article group	N15
quantity unit	m

Weight

Weight per quantity unit	4,700 kg / m
Weight in kg per 100	470 kg / 100m

Technical Datasheet

Cable Tray System

KK 80.600

the photorealistic images are to be considered as reference images

Physical Article Dimensions

Height	80.00 mm
Width	600 mm
Depth/length	3000 mm

Packing Dimension

3 meters = 1 piece		✓ VP1-smallest packaging unit (PU)		✓ VP1-preferred PU	
Lenght	3000 mm	Width	600 mm	Height	80.00 mm
Gross weight	14 kg	Volume	0,144 m ³		
Min. quantity	3.00 m	Max. Quantity	3.00 m		

66 meters = 1 rack					
Lenght	3000 mm	Width	1162 mm	Height	1120 mm
Gross weight	408 kg	Volume	3,904 m ³		
Min. Quantity	66.00 m	Max. Quantity	66.00 m		

Tender Text

GRP cable tray, pressed, with unperforated side beams and bottom, with moulded connector and with transverse reinforcements (5 mm) over the entire cable tray width in the bottom, mechanical strength acc. to IEC 61537, please order proportional fastening accessories separately, halogen-free.

Due to the transverse reinforcements, the cable tray is also approved for use with high-frequency cables acc. to UTE C15-900 (application class D, frequency 16 MHz).

An expansion distance of 8 mm must be taken into account. Due to the expansion of the material, the following must be observed during installation:

- The cable tray should not be screwed close to or at the joint.
- When screwing the cable tray onto the brackets, a through hole of Ø 9 mm for the FKM 6X20 E4 screws must always be made in the tray.

Article available in various resin mixtures.

Dimensions (approx. dimensions)

H x W : 80 x 600 mm

Material thickness t : 4 mm

Bottom beading : 60 x 5 mm

Bottom beading Grid dimension : 313 mm

Load-bearing capacity F

at a support distance of 1.5 m : 1 kN/m

Delivery length : 3000 mm

Usable cross-section : 42120 mm²

Material : UP-GF (glass-fibre reinforced polyester)

Colour : pebble grey

RAL : 7032 (similar)

NIEDAX Model no. : KK 80.600

EP Material _____ EP Wage _____

Unit price/meter

Technical Datasheet

Cable Tray System

KK 80.600

the photorealistic images are to be considered as reference images

Safety & Environment

REACH Date	25.06.2025
REACH Info	Conformable
RoHS Info	Conformable

Origin & International Trade

Country of origin	FR
Customs tariff number	39259020

Related items

Cover

Model No.	Description
KKD 600	GRP-cover for cable tray/-ladder, 600x3000 mm, Polyester glasfaserverstärkt, gepresst, RAL 7032, kieselgrau

Barrier strip

Model No.	Description
FKM 6X16 E4	Slotted mushroom head screw w/. nut and washer, M6x16, Edelstahl, Werkstoff-Nr.: 1.4401, 1.4404
KKT 80	GRP-barrier strip for cable tray, 65x3000 mm, Polyester glasfaserverstärkt, gepresst, RAL 7032, kieselgrau
KKT 80/M	GRP-barrier strip for cable tray, 65x3000 mm, pre-assembled, glass fiber reinforced polyester, pressed, RAL 7032, pebble grey