

Outside Elbow 45°

incl. cover

LUAB 60.100

EAN Code: 4013339512904
 Smallest packaging unit: 8 pcs.

the photorealistic images are to be considered as reference images

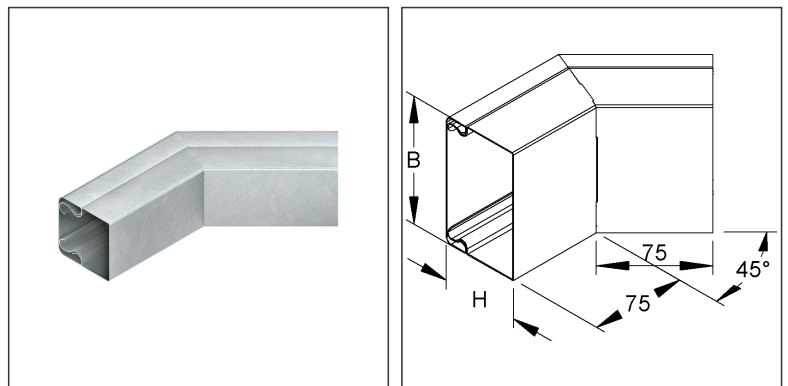
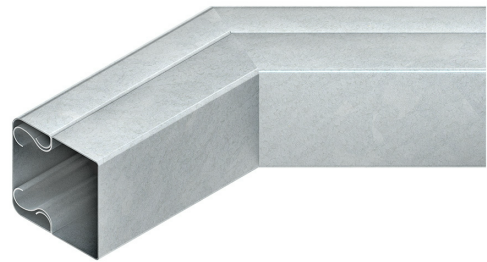

Article Description

Outside elbow 45° with cover, 60x100 mm, steel, pre-galvanised according to DIN EN 10346

Additional Price Information

Article group	N16
quantity unit	pcs.

Weight

Weight per quantity unit	427 g/ pcs.
Weight in kg per 100	43 kg/ 100pcs.

Physical Article Dimensions

Height	100.00 mm
Width	114.00 mm
Depth/length	171.00 mm

Technical Datasheet

Cable protection duct

LUAB 60.100

the photorealistic images are to be considered as reference images

Packing Dimension

1 piece = 1 piece		✓ VP1-smallest packaging unit (PU)			
Lenght	171.00 mm	Width	114.00 mm	Height	100.00 mm
Gross weight	0,43 kg	Volume	0,002 m ³		
Min. quantity	1.00 pcs.	Max. Quantity	1.00 pcs.		
8 pieces = 1 carton		✓ VP2-preferred PU			
Lenght	480 mm	Width	280 mm	Height	140.00 mm
Gross weight	4,3 kg	Volume	0,019 m ³		
Min. Quantity	8.00 pcs.	Max. Quantity	8.00 pcs.		

Tender Text

Cable trunking outside elbow 45°, with snap-on cover, duct bottom part unperforated, the equipotential bonding of the covers is carried out automatically when snapping on, accessories for equipotential bonding, two splice plates LST... per joint, must be ordered separately.
 VDE certified!
 Used for: cable trunkings LLK...
 LUK...
 Dimensions (approx. dimensions)
 Height H x width W : 60 x 100 mm
 Leg length inside : 75 mm
 Material : steel, pre-galvanised acc. to DIN EN 10346
 NIEDAX Model No. : LUAB 60.100
 EP Material _____ EP Lohn _____
 Unit price/piece

Safety & Environment

REACH Date	05.11.2025
REACH Info	Conformable
RoHS Info	Conformable

Origin & International Trade

Country of origin	DE
Customs tariff number	73089059