

Industrial Duct

unperforated, but with screw connector perforation, without cover

LUE 60.100

EAN Code: 4013339532742

Smallest packaging unit: 2 m

quantity unit: m M



the photorealistic images are to be considered as reference images

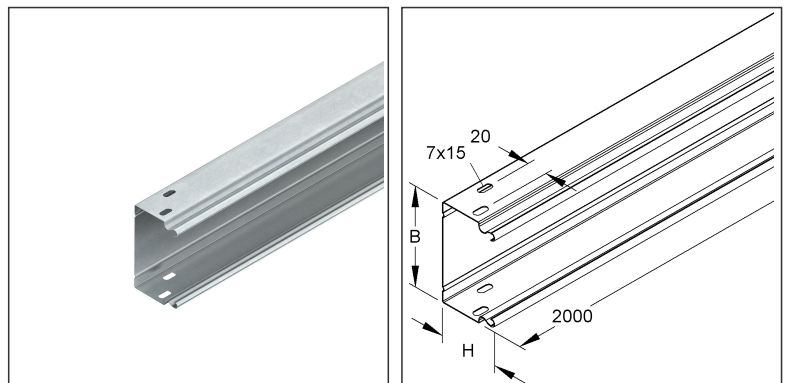

Article Description

Industrial duct without cover, 60x100x2000 mm, steel, pre-galvanised according to DIN EN 10346

Additional Price Information

Article group	N16
quantity unit	m

Weight

Weight per quantity unit	1,451 kg / m
Weight in kg per 100	145 kg / 100m

Physical Article Dimensions

Height	100.00 mm
Width	60.00 mm
Depth/length	2000 mm

Technical Datasheet

Cable protection duct

LUE 60.100

the photorealistic images are to be considered as reference images

Packing Dimension

2 meters = 1 piece		✓ VP1-smallest packaging unit (PU)	✓ VP1-preferred PU
Lenght	2000 mm	Width	60.00 mm
		Height	100.00 mm
Gross weight	2,9 kg	Volume	0,012 m ³
Min. quantity	2.00 m	Max. Quantity	2.00 m

Tender Text

Industrial duct, duct bottom part unperforated but with offset screw connector perforations in the sides, without cover, accessories for equipotential bonding, two splice plates LIV 60 per joint, must be ordered separately.
 VDE certified!
 Dimensions (approx. dimensions) H x W : 60 x 100 mm
 Delivery length L : 2000 mm
 Usable cross-section : 5582 mm²
 Material : steel, pre-galvanised acc. to DIN EN 10346
 NIEDAX Model No. : LUE 60.100
 EP Material _____ EP Wage _____
 Unit price/meter

Safety & Environment

REACH Date	05.11.2025
REACH Info	Conformable
RoHS Info	Conformable

Origin & International Trade

Country of origin	DE
Customs tarif number	73089059

Related items

Cover

Model No.	Description
LD 100	Cable trunking cover, 100x2000 mm, steel, pre-galvanised according to DIN EN 10346

Barrier strip

Model No.	Description
LZTP 100	Barrier profile holder with strain relief, channel depth 99 mm, steel, pre-galvanised according to DIN EN 10346
RW 60	Barrier strip, 55x3000 mm, t=0,75 mm, steel, pre-galvanised according to DIN EN 10346, incl. accessories
TPS 50	Barrier strip, height 11 mm, depth 50 mm, length 1996 mm, steel, pre-galvanised according to DIN EN 10346

Technical Datasheet

Cable protection duct

LUE 60.100

the photorealistic images are to be considered as reference images

Related items

Connector

Model No.	Description
LIV 60	Universal-splice plate, asymmetrical, steel, pre-galvanised according to DIN EN 10346, incl. accessories