

Cable Trunking

without bottom perforation, with cover

LUK 100.100 E3

EAN Code: 4013339520244
 Smallest packaging unit: 4 x 2 m
 quantity unit: m M

the photorealistic images are to be considered as reference images

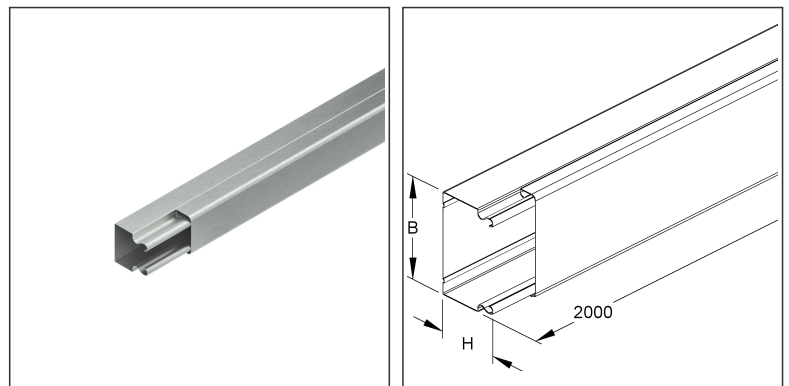

Article Description

Cable trunking with cover, 100x100x2000 mm, stainless steel, material code: 1.4301, AISI 304

Additional Price Information

Article group	N16
quantity unit	m

Weight

Weight per quantity unit	3,014 kg / m
Weight in kg per 100	301 kg / 100m

Physical Article Dimensions

Height	100.00 mm
Width	99.80 mm
Depth/length	2000 mm

Technical Datasheet

Cable protection duct

LUK 100.100 E3

the photorealistic images are to be considered as reference images

Packing Dimension

8 meters = 1		✓ VP1-smallest packaging unit (PU)		✓ VP1-preferred PU	
Lenght	2020 mm	Width	225 mm	Height	130.00 mm
Gross weight	25 kg	Volume	0,059 m ³		
Min. quantity	8.00 m	Max. Quantity	8.00 m		
192 meters = 1 rack					
Lenght	2000 mm	Width	1162 mm	Height	1120 mm
Gross weight	699 kg	Volume	2,603 m ³		
Min. Quantity	192.00 m	Max. Quantity	192.00 m		

Tender Text

Cable trunking, unperforated, with snap-on cover, the equipotential bonding of the covers takes place automatically when snapped on, accessories for equipotential bonding, two splice plates LST...E3 per joint, must be ordered separately.

Dimensions (approx. dimensions)

Height H x Width W : 100 x 100 mm

Delivery length L : 2000 mm

Usable cross-section : 9582 mm²

Material : stainless steel, material no. 1.4301, AISI 304

NIEDAX Model No. : LUK 100.100 E3

EP Material _____ EP Wage _____

Unit price/meter

Safety & Environment

REACH Date	25.06.2025
REACH Info	Conformable
RoHS Info	Conformable

Origin & International Trade

Country of origin	DE
Customs tariff number	73089059

Related items

Barrier strip

Model No.	Description
LZTP 100 E3	Barrier profile holder with strain relief, channel depth 99 mm, stainless steel, material code: 1.4301, AISI 304
TPS 90 E3	Barrier strip, height 11 mm, depth 90 mm, length 1996 mm, stainless steel, material code: 1.4301, AISI 304

Technical Datasheet

Cable protection duct

LUK 100.100 E3

the photorealistic images are to be considered as reference images

Related items

Connector

Model No.	Description
LST 100 E3	Splice plate with flat plug, for height 100 mm, stainless steel, material code: 1.4301, AISI 304