

ITEM	UNIT	QTY
1		
2		
3		
4		
5		
6		
EX.	404	2

ASTROCLEAN SIZE GUIDE						
ACF SIZE	FILTRATION AREA W X L (IN.)	CFM @ 90 FPM	FILTER QTY	FILTER SIZE (RSR GEL SEAL)	FAN QTY	MIN. CIRCUIT AMPACITY
404	48" X 51"	1,530	2	21-3/4" X 44"	2	230V/460V
406	48" X 78"	2,340	3	21-3/4" X 44"	2	12A/10.5A
408	48" X 105"	3,150	4	21-3/4" X 44"	2	12A/10.5A
606	72" X 78"	3,510	6	21-3/4" X 32"	2	12.6A/11.1A
608	72" X 105"	4,725	8	21-3/4" X 32"	2	12A/10.5A
610	72" X 132"	5,940	10	21-3/4" X 32"	2	22.4A/19.6A
808	96" X 105"	6,300	8	21-3/4" X 44"	3	23A/20.2A
810	96" X 132"	7,920	10	21-3/4" X 44"	3	30.5A/26.6A
812	96" X 159"	9,540	12	21-3/4" X 44"	3	31.1A/27.2A
						31.7A/27.8A

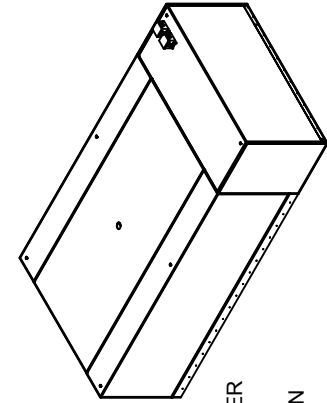

ISOMETRIC VIEW

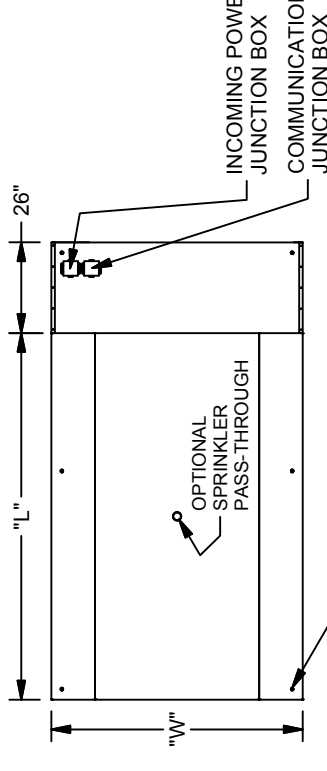

TOP VIEW

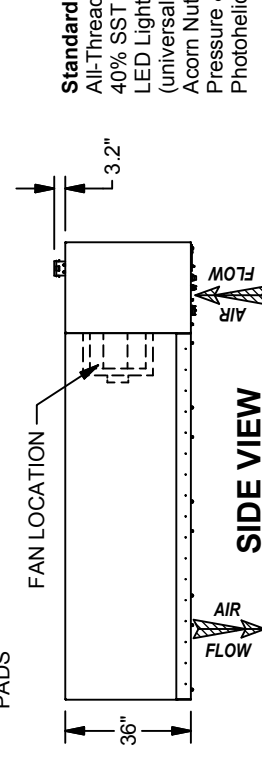

SIDE VIEW

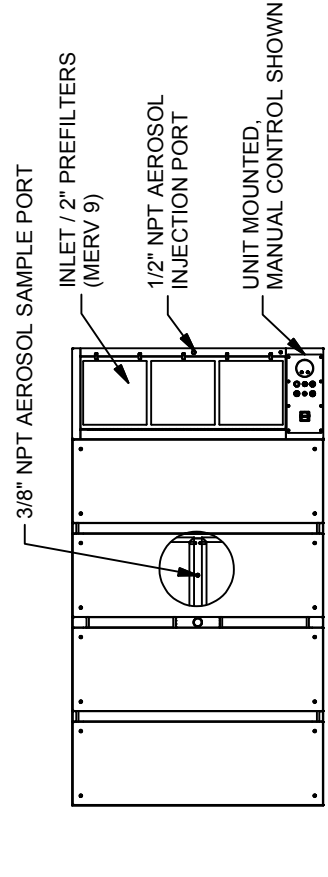

BOTTOM VIEW

Standard Features:
 All-Thread Suspension Mounting
 40% SST Grille (same material as housing construction)
 LED Lighting with dimmer circuit (universal voltage 120-277V)
 Acorn Nut & Stud Mounted Grille
 Pressure & Upstream Aerosol Sample Ports - 3/8" NPT Plug
 Photohelic Gauges

- VOLTAGE**
- 230V 3PH
 - 460V 3PH
- MATERIAL**
- 304 STAINLESS STEEL
 - 316L STAINLESS STEEL
- HOUSING WELDING**
- CONTINUOUSLY WELDED GRID/ ROOMSIDE (STANDARD)
 - CONTINUOUSLY WELDED PLENUM & GRID
- HOUSING FINISH**
- #4 FINISH ROOMSIDE FILTRATION AREA ONLY
 - #4 FINISH ROOMSIDE + ALL EXTERIOR SURFACES
- PERIMETER TRIM (#4 FINISH SAME MATERIAL AS HOUSING)**
- NONE
 - 2" FIELD INSTALLED FLUSH CEILING MOUNT
 - 2" FIELD INSTALLED OFFSET CEILING MOUNT
- AMOUNT OFFSET FROM BOTTOM OF GRILLE FACE
- 6"
 - 12"
 - 18"
 - 24"
 - 36"
- AEROSOL INJECTION**
- NONE
 - ROOMSIDE - 1/2" NPT
- SPRINKLER**
- NONE
 - SPRINKLER PASS-THROUGH (CENTRALLY LOCATED IN FILTRATION AREA)
- CONTROLS**
- UNIT MOUNTED, MANUAL CONTROL
 - REMOTE MOUNTED, ASTRODRIVE, MODBUS RS-485, REMOTE

CUSTOMER APPROVAL

DRAWINGS MUST BE SIGNED IN ORDER TO PROCEED WITH PRODUCTION.
 APPROVED APPROVED AS NOTED NOT APPROVED

SIGNATURE: _____ DATE: _____

COMMENTS: _____

QUOTE NO.: _____

UNLESS OTHERWISE SPECIFIED DIMENSIONS ARE IN INCHES TOLERANCES ARE:

FRACTIONS X/XX ±1/8
 DECIMALS X.XX ±0.13
 DIAGONALS ±1/8

THE INFORMATION CONTAINED ON THIS DRAWING IS THE PROPERTY OF AAF AND MAY NOT BE USED, REPRODUCED NOR TRANSMITTED TO OTHER PARTIES WITHOUT EXPRESSED WRITTEN CONSENT OF AAF.

AAAF
 A member of DANFAB Group

TITLE: ASTROCLEAN - FPS - UFM SALES DRAWING

DRAWN BY: R. DUNN
 CHECKED BY: _____
 DATE: 11/11/2020

APPROVED BY: _____
 DATE: _____

SHEET SIZE: A
 SHEET SCALE: 1 OF 6
 DRAWING NUMBER: 600-00023
 REV: A

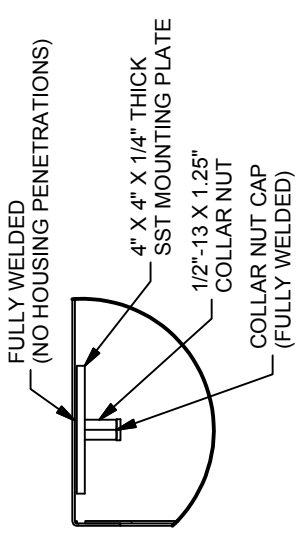

MOUNT DETAIL

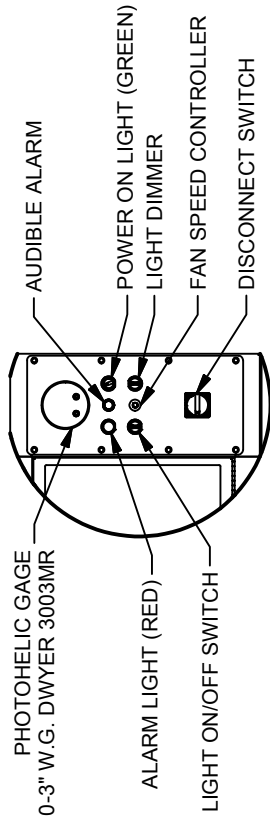

UNIT MOUNTED GAGE PANEL DETAIL

PRESSURE PORT DETAIL
PROVIDED WITH REMOTE MOUNTED CONTROLS

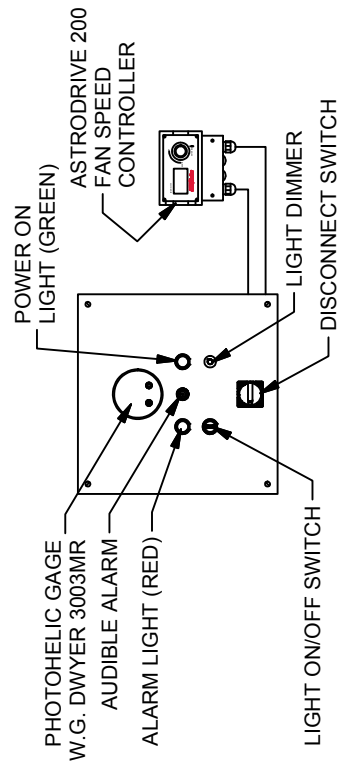

REMOTE MOUNTED DETAIL
(FIELD INSTALLED NEMA 4X ENCLOSURE)

AEROSOL SAMPLE PORT DETAIL

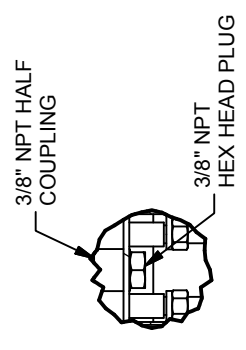

TYPICAL LIGHT DETAIL

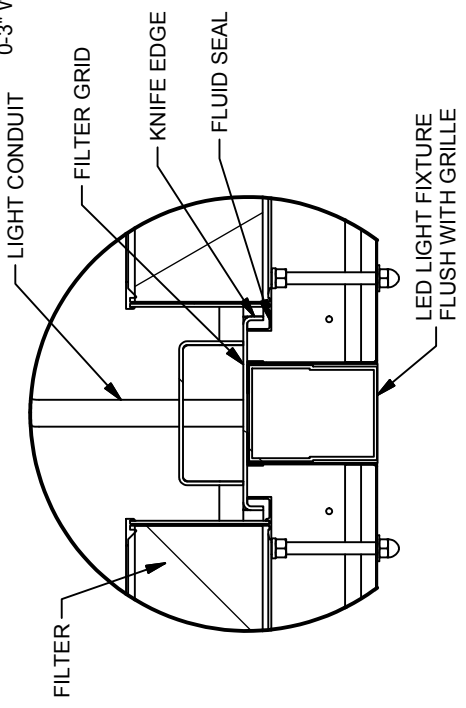

FILTER RETAINER DETAIL

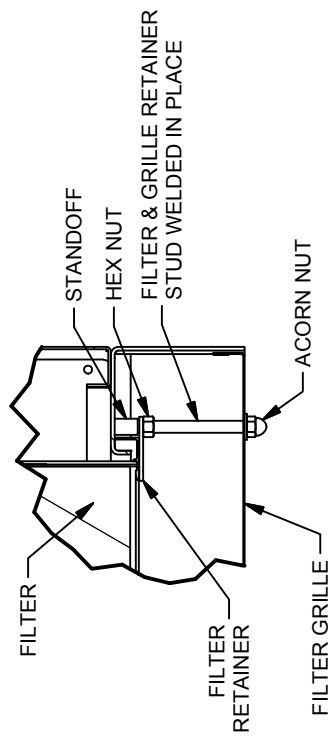

CUSTOMER APPROVAL
DRAWINGS MUST BE SIGNED IN ORDER TO PROCEED WITH PRODUCTION.
[] APPROVED [] NOT APPROVED

SIGNATURE: _____ DATE: _____
COMMENTS: _____
QUOTE NO.: _____



TITLE: ASTROCLEAN - FPS - UFM SALES DRAWING	
DRAWN BY: R. DUNN	APPROVED BY: _____
DATE: 11/11/2020	DATE: _____
DRAWING NUMBER	SHEET SIZE: 2 OF 6
600-00023	SHEET SCALE: 1 / 55
	REV: A

UNLESS OTHERWISE SPECIFIED DIMENSIONS ARE IN INCHES TOLERANCES ARE:

FRACTIONS X/8 ±1/8
DECIMALS X.XX ±0.13
DIAGONALS X.XX ±1/8

THE INFORMATION CONTAINED ON THIS DRAWING IS THE PROPERTY OF AAF AND MAY NOT BE USED, REPRODUCED NOR TRANSMITTED TO OTHER PARTIES WITHOUT EXPRESSED WRITTEN CONSENT OF AAF.

ITEM	UNIT	QTY
1		
2		
3		
4		
5		
6		
EX.	404	2

ASTROCLEAN SIZE GUIDE						
ACP SIZE	FILTRATION AREA W X L (IN.)	CFM @ 90 FPM	FILTER QTY	FILTER SIZE (RSR GEL SEAL)	FAN QTY	MIN. CIRCUIT AMPACITY 230V/460V
404	48" X 51"	1,530	2	21-3/4" X 44"	2	12A/10.5A
406	48" X 78"	2,340	3	21-3/4" X 44"	2	12A/10.5A
408	48" X 105"	3,150	4	21-3/4" X 44"	2	12.6A/11.1A
606	72" X 78"	3,510	6	21-3/4" X 32"	2	12A/10.5A
608	72" X 105"	4,725	8	21-3/4" X 32"	2	22.4A/19.6A
610	72" X 132"	5,940	10	21-3/4" X 32"	3	31.1A/27.2A
808	96" X 105"	6,300	8	21-3/4" X 44"	3	30.5A/26.6A
810	96" X 132"	7,920	10	21-3/4" X 44"	3	31.1A/27.2A
812	96" X 159"	9,540	12	21-3/4" X 44"	3	31.7A/27.8A

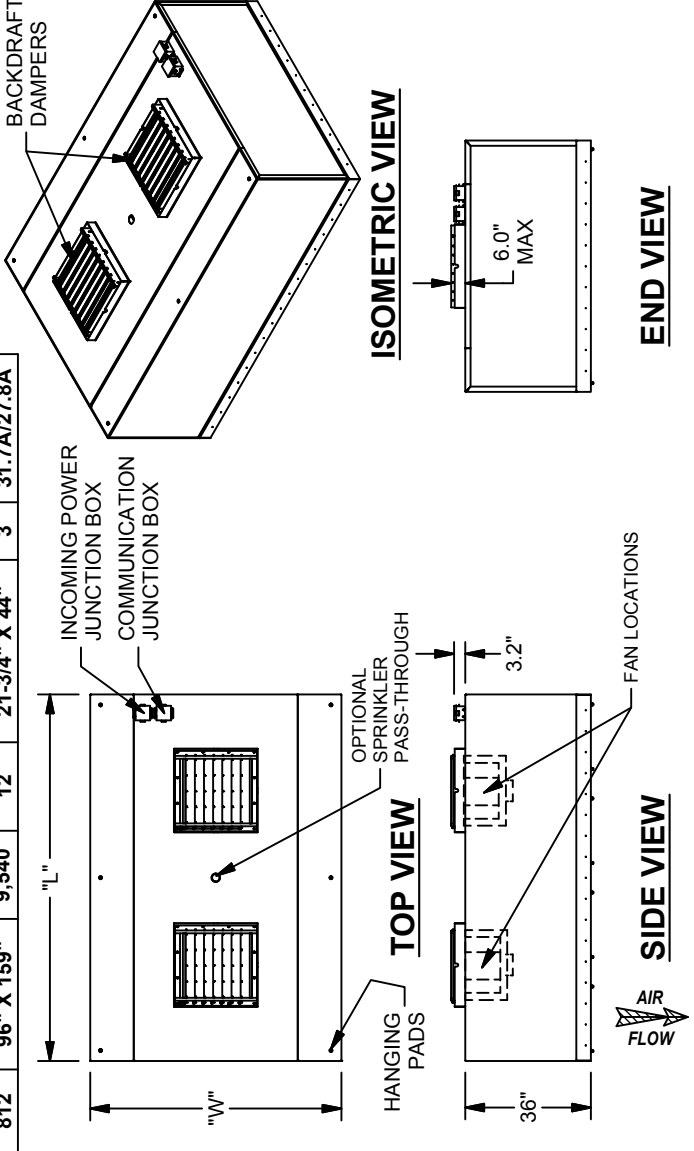

- VOLTAGE**
- 230V 3PH
 - 460V 3PH
- MATERIAL**
- 304 STAINLESS STEEL
 - 316L STAINLESS STEEL
- HOUSING WELDING**
- CONTINUOUSLY WELDED GRID/ ROOMSIDE (STANDARD)
 - CONTINUOUSLY WELDED PLENUM & GRID
- HOUSING FINISH**
- #4 FINISH ROOMSIDE FILTRATION AREA ONLY
 - #4 FINISH ROOMSIDE + ALL EXTERIOR SURFACES
- PERIMETER TRIM (#4 FINISH SAME MATERIAL AS HOUSING)**
- NONE
 - 2" FIELD INSTALLED FLUSH CEILING MOUNT
 - 2" FIELD INSTALLED OFFSET CEILING MOUNT
- AMOUNT OFFSET FROM BOTTOM OF GRILLE FACE**
- 6"
 - 12"
 - 18"
 - 24"
 - 36"
- AEROSOL INJECTION**
- NONE (UPSTREAM RECOMMENDED)
 - ROOMSIDE - 1/2" NPT
- SPRINKLER**
- NONE
 - SPRINKLER PASS-THROUGH (CENTRALLY LOCATED IN FILTRATION AREA)

CUSTOMER APPROVAL

DRAWINGS MUST BE SIGNED IN ORDER TO PROCEED WITH PRODUCTION.
 APPROVED APPROVED AS NOTED NOT APPROVED

SIGNATURE: _____ DATE: _____

COMMENTS: _____

QUOTE NO.: _____

UNLESS OTHERWISE SPECIFIED DIMENSIONS ARE IN INCHES TOLERANCES ARE:

FRACTIONS X/8 ±1/8
 DECIMALS X.XX ±0.13
 DIAGONALS X.XX ±1/8

THE INFORMATION CONTAINED ON THIS DRAWING IS THE PROPERTY OF AAF AND MAY NOT BE USED, REPRODUCED NOR TRANSMITTED TO OTHER PARTIES WITHOUT EXPRESSED WRITTEN CONSENT OF AAF.

AAFLIGHT SYSTEMS A number of DANFAB Group

TITLE: ASTROCLEAN - FPT - UFM SALES DRAWING

DRAWN BY: R.DUNN
 CHECKED BY: _____
 DATE: 11/11/2020
 DATE: _____

APPROVED BY: _____
 DATE: _____

SHEET 3 OF 6
 SHEET SIZE A
 SCALE 1 / 55

DRAWING NUMBER 600-00023
 REV A

Standard Features:

- All-Thread Suspension Mounting
- 40% SST Grille (same material as housing construction)
- LED Lighting with dimmer circuit (universal voltage 120-277V)
- Acorn Nut & Stud Mounted Grille
- Pressure & Upstream Aerosol Sample Ports - 3/8" NPT Plug
- Photohelic Gauges
- Backdraft Dampers to prevent air recirculation
- N + 1 Fan Redundancy
- Remote mounted NEMA 4X control panel with ASTRODRIVE AD-200 MODBUS RS-485

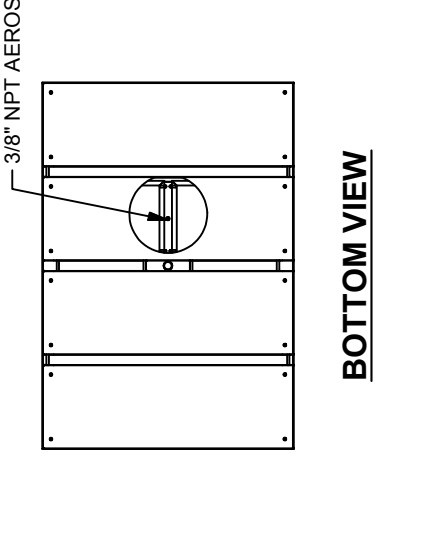

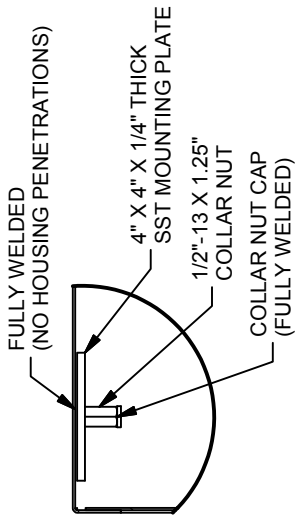

MOUNT DETAIL

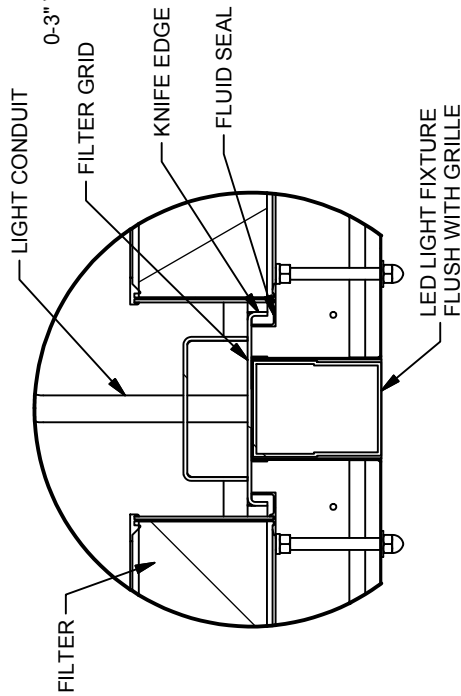

TYPICAL LIGHT DETAIL

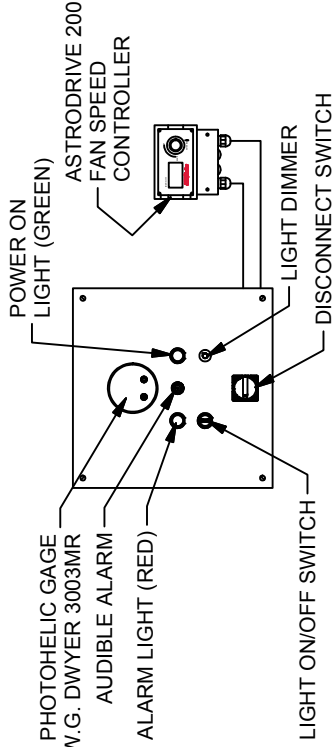

**REMOTE MOUNTED DETAIL
(FIELD INSTALLED NEMA 4X ENCLOSURE)**



PRESSURE PORT DETAIL

PROVIDED WITH REMOTE MOUNTED CONTROLS

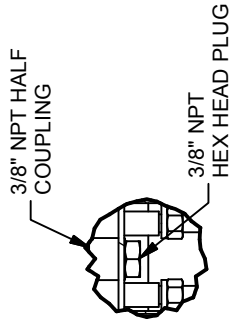

**AEROSOL SAMPLE
PORT DETAIL**

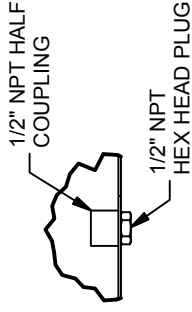

**AEROSOL INJECTION
PORT DETAIL**

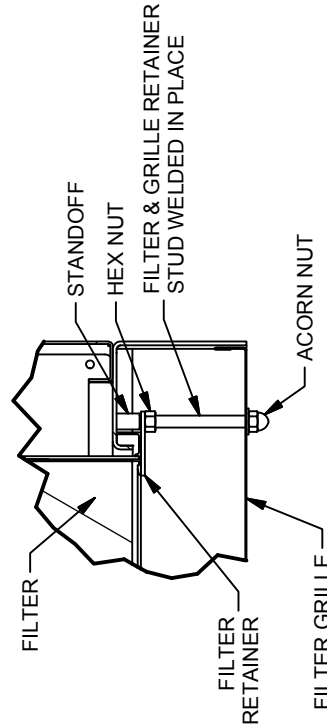

FILTER RETAINER DETAIL

CUSTOMER APPROVAL

DRAWINGS MUST BE SIGNED IN ORDER TO PROCEED WITH PRODUCTION.
 APPROVED NOT APPROVED

SIGNATURE: _____ DATE: _____
 COMMENTS: _____
 QUOTE NO.: _____



TITLE: ASTROCLEAN - FPT - UFM SALES DRAWING

DRAWN BY R. DUNN	CHECKED BY	APPROVED BY	SHEET 4 OF 6	SHEET SIZE A	SCALE 1 / 55
DATE 11/11/2020	DATE	DATE	DRAWING NUMBER 600-00023		
UNLESS OTHERWISE SPECIFIED DIMENSIONS ARE IN INCHES TOLERANCES ARE:			REV A		

FRACTIONS X/8 ±1/8
 DECIMALS X.XX ±0.13
 DIAGONALS ±1/8

THE INFORMATION CONTAINED ON THIS
 DRAWING IS THE PROPERTY OF AAF
 AND MAY NOT BE USED, REPRODUCED NOR
 TRANSMITTED TO OTHER PARTIES WITHOUT
 EXPRESSED WRITTEN CONSENT OF AAF.

REV ECN # DESCRIPTION BY DATE

ITEM	UNIT	QTY
1		
2		
3		
4		
5		
6		
EX.	404	2

ASTROCLEAN SIZE GUIDE						
ACP SIZE	FILTRATION AREA W X L (IN.)	CFM @ 90 FPM	FILTER QTY	FILTER SIZE (RSR GEL SEAL)	INLET QTY	INLET SIZE (IN.)
404	48" X 51"	1,530	2	21-3/4" X 44"	1	18" X 18"
406	48" X 78"	2,340	3	21-3/4" X 44"	1	18" X 18"
408	48" X 105"	3,150	4	21-3/4" X 44"	2	18" X 18"
606	72" X 78"	3,510	6	21-3/4" X 32"	2	18" X 18"
608	72" X 105"	4,725	8	21-3/4" X 32"	2	18" X 18"
610	72" X 132"	5,940	10	21-3/4" X 32"	3	18" X 18"
808	96" X 105"	6,300	8	21-3/4" X 44"	3	18" X 18"
810	96" X 132"	7,920	10	21-3/4" X 44"	3	18" X 18"
812	96" X 159"	9,540	12	21-3/4" X 44"	4	18" X 18"

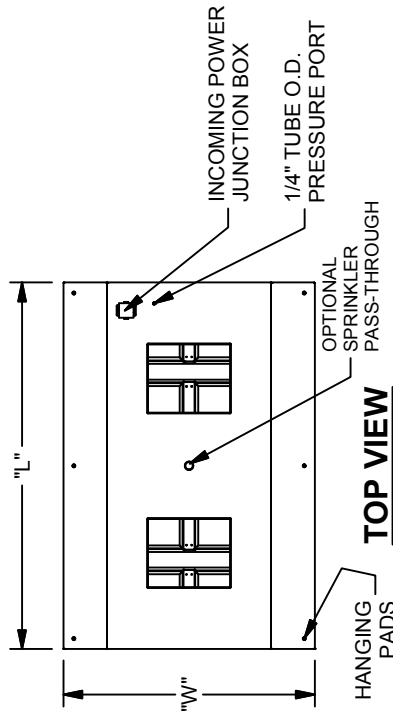

ISOMETRIC VIEW

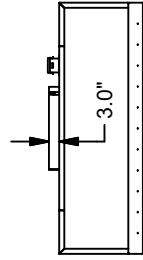
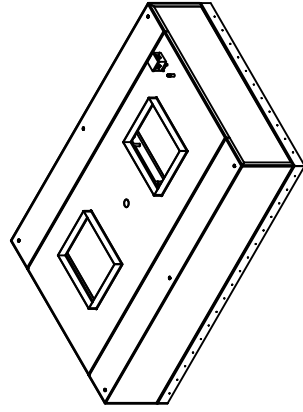

END VIEW

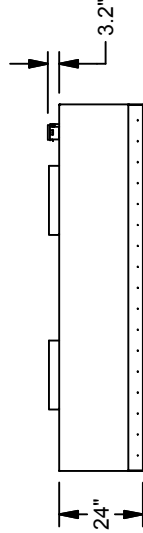

SIDE VIEW

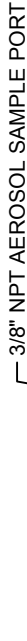

BOTTOM VIEW

Standard Features:
 All-Thread Suspension Mounting
 40% SST Grille (same material as housing construction)
 LED Lighting with dimmer circuit (universal voltage 120-277V)
 Acorn Nut & Stud Mounted Grille
 Pressure & Upstream Aerosol Sample Ports - 3/8" NPT Plug

- MATERIAL**
- 304 STAINLESS STEEL
 - 316L STAINLESS STEEL
- HOUSING WELDING**
- CONTINUOUSLY WELDED GRID/ ROOMSIDE (STANDARD)
 - CONTINUOUSLY WELDED PLENUM & GRID
- HOUSING FINISH**
- #4 FINISH ROOMSIDE FILTRATION AREA ONLY
 - #4 FINISH ROOMSIDE + ALL EXTERIOR SURFACES
- PERIMETER TRIM (#4 FINISH SAME MATERIAL AS HOUSING)**
- NONE
 - 2" FIELD INSTALLED FLUSH CEILING MOUNT
 - 2" FIELD INSTALLED OFFSET CEILING MOUNT
 - AMOUNT OFFSET FROM BOTTOM OF GRILLE FACE
 - 6"
 - 12"
 - 18"
 - 24"

- AEROSOL INJECTION**
- NONE (UPSTREAM RECOMMENDED)
 - ROOMSIDE - 1/2" NPT

- SPRINKLER**
- NONE
 - SPRINKLER PASS-THROUGH (CENTRALLY LOCATED IN FILTRATION AREA)

CUSTOMER APPROVAL
 DRAWINGS MUST BE SIGNED IN ORDER TO PROCEED WITH PRODUCTION.
 APPROVED APPROVED AS NOTED NOT APPROVED

SIGNATURE: _____ DATE: _____
 COMMENTS: _____
 QUOTE NO.: _____



TITLE: ASTROCLEAN - DAP - UFM SALES DRAWING

DRAWN BY R. DUNN	CHECKED BY	APPROVED BY	SHEET	SHEET	SCALE
DATE 11/11/2020	DATE	DATE	5 OF 6	A	1 / 55
DRAWING NUMBER			REV		
			600-00023 A		

UNLESS OTHERWISE SPECIFIED
 DIMENSIONS ARE IN INCHES
 TOLERANCES ARE:

FRACTIONS X/8 ±1/8
 DECIMALS X.XX ±0.13
 DIAGONALS ±1/8

THE INFORMATION CONTAINED ON THIS
 DRAWING IS THE PROPERTY OF AAF
 AND MAY NOT BE USED, REPRODUCED NOR
 TRANSMITTED TO OTHER PARTIES WITHOUT
 EXPRESSED WRITTEN CONSENT OF AAF.

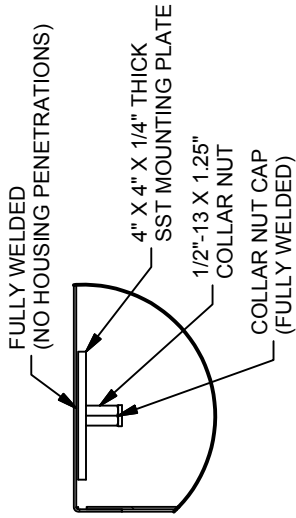

MOUNT DETAIL

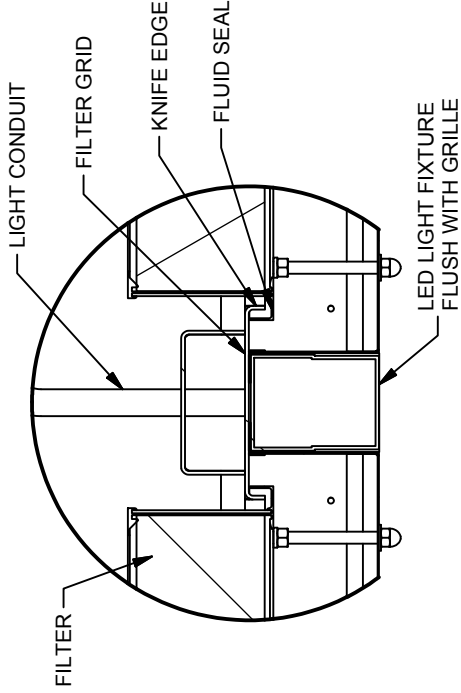

TYPICAL LIGHT DETAIL

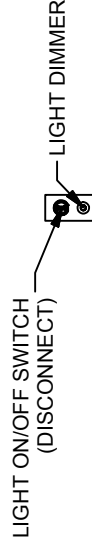

**REMOTE MOUNTED DETAIL
(LIGHTS ONLY FIELD INSTALLED)**

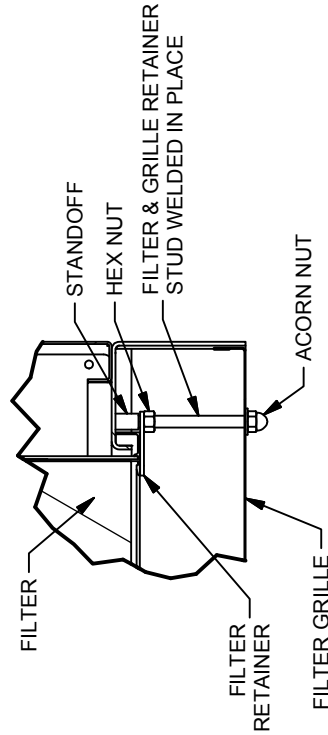

FILTER RETAINER DETAIL

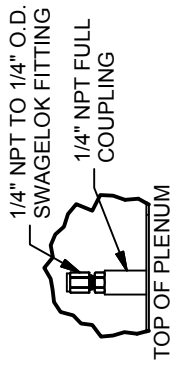

PRESSURE PORT DETAIL

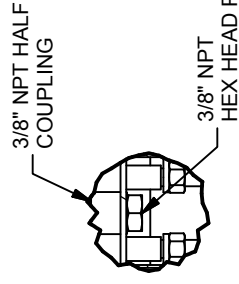

AEROSOL SAMPLE PORT DETAIL

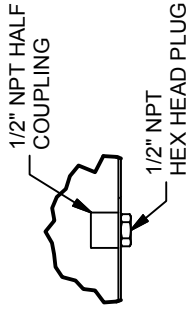

AEROSOL INJECTION PORT DETAIL

CUSTOMER APPROVAL
DRAWINGS MUST BE SIGNED IN ORDER TO PROCEED WITH PRODUCTION.
[] APPROVED [] NOT APPROVED

SIGNATURE: _____ DATE: _____
COMMENTS: _____
QUOTE NO.: _____



TITLE: ASTROCLEAN - DAP - UFM SALES DRAWING

DRAWN BY R. DUNN	CHECKED BY	APPROVED BY	SHEET 6 OF 6	SHEET SCALE A
DATE 11/11/2020	DATE	DATE	SIZE A	SCALE 1 / 55
DRAWING NUMBER			REV A	

600-00023

UNLESS OTHERWISE SPECIFIED
DIMENSIONS ARE IN INCHES
TOLERANCES ARE:

FRACTIONS X/8 ±1/8
DECIMALS X.XX ±0.13
DIAGONALS ±1/8

THE INFORMATION CONTAINED ON THIS
DRAWING IS THE PROPERTY OF AAF
AND MAY NOT BE USED, REPRODUCED NOR
TRANSMITTED TO OTHER PARTIES WITHOUT
EXPRESSED WRITTEN CONSENT OF AAF.