



ACCURATE

LOCK & HARDWARE

AMERICAN CRAFTED SINCE 1972

9100SEC HIGH SECURITY MORTISE LOCK

WITHSTANDS 300X MORE ABUSE



RESIDENTIAL & COMMERCIAL

This detention-grade mortise lock can be paired with any architectural trim in residential or commercial settings. Achieve optimal safety without compromising style.



BEHAVIORAL HEALTH

Shown here with ADA compliant + ligature resistant trim featuring paperclip protection. Ideal for use in behavioral healthcare settings.



INSTITUTIONAL

Paired with high security, detention grade trim, this lock ensures the prevention of unauthorized passage to secure areas, confines inmates and will delay or frustrate escape attempts.



9100SEC HIGH SECURITY MORTISE LOCK

DETAILS

- Proven to withstand over 300 times more abuse than the standard Grade 1 mortise lock requirement.
- Originally developed to resist physical attack & vandalism in detention facilities.
- For use in residential entrances, schools/universities, detention centers and healthcare facilities.
- Ideal for new and retrofit installations.
- Available in all functions and a variety of backsets.
- Can be used with a variety of commercial, residential, and specialty trim in a standard ANSI mortise prep.
- Conforms to Federal Specification FF-H-106 Series 86/87.
- Achieve optimal safety without compromising style.

ADVANTAGES

- Patent pending technology
- Compatibility with industry master key systems
- Anti-vandal trim features 2-point lever attachment for added security preventing removal and conversion into weapon
- Customizable solution unique to facility needs
- Rapid prototyping and fabrication
- Compatible with other manufacturer security trim
- Ligature resistant applications
- Optional large escutcheons for existing door retrofits/upgrade

| | Standard Mortise Lock | High Security Mortise Lock |
|---|-----------------------|--|
| Standard Grade 1 Test: [ANSI/BHMA A156.13] 2 blows @60 ft/lbs 2 blows @90ft/lbs 2 blows @120 ft/lbs 2 blows @150 ft/lbs | ✓ | ✓ |
| Detention Grade 1 Test: [ASTM F1577-05] 600 blows @200 ft/lbs in 60 mins | | Latchbolt Only: 600 blows @200 ft/lbs in 60 mins ✓ |
| | | Latchbolt and Deadbolt: 2,400 blows @200 ft/lbs in 4 hours ✓✓✓✓ Exceeded passing results by 4X |

9100SEC HIGH SECURITY MORTISE LOCK

UL Listed 3 Hour (R13846).

Grade 1 Certified to ANSI/BHMA A156.13.2005.

Exceeds ASTM F1577-95b Security Grade 1 (2,400 Impacts)

BACKSET: 2 ½", 2 ¾"

Other backsets available as a special order.

CASE: Heavy Gauge, Plated Steel.

ARMOR FRONT: Fortified stainless steel with adjustable bevel.

Features SHOCK PROOF linkage that absorbs lock case deflection during impact

Deadbolt: Hardened 1.25" (32mm) solid stainless steel bolt x 1" (25mm) throw.

Latch bolt: Single solid stainless steel latch bolt with 1" (25mm) overall height x ¾" (19mm) throw

All exposed screws are Torx Security type



9167SEC



LOCK SPECIFICATIONS

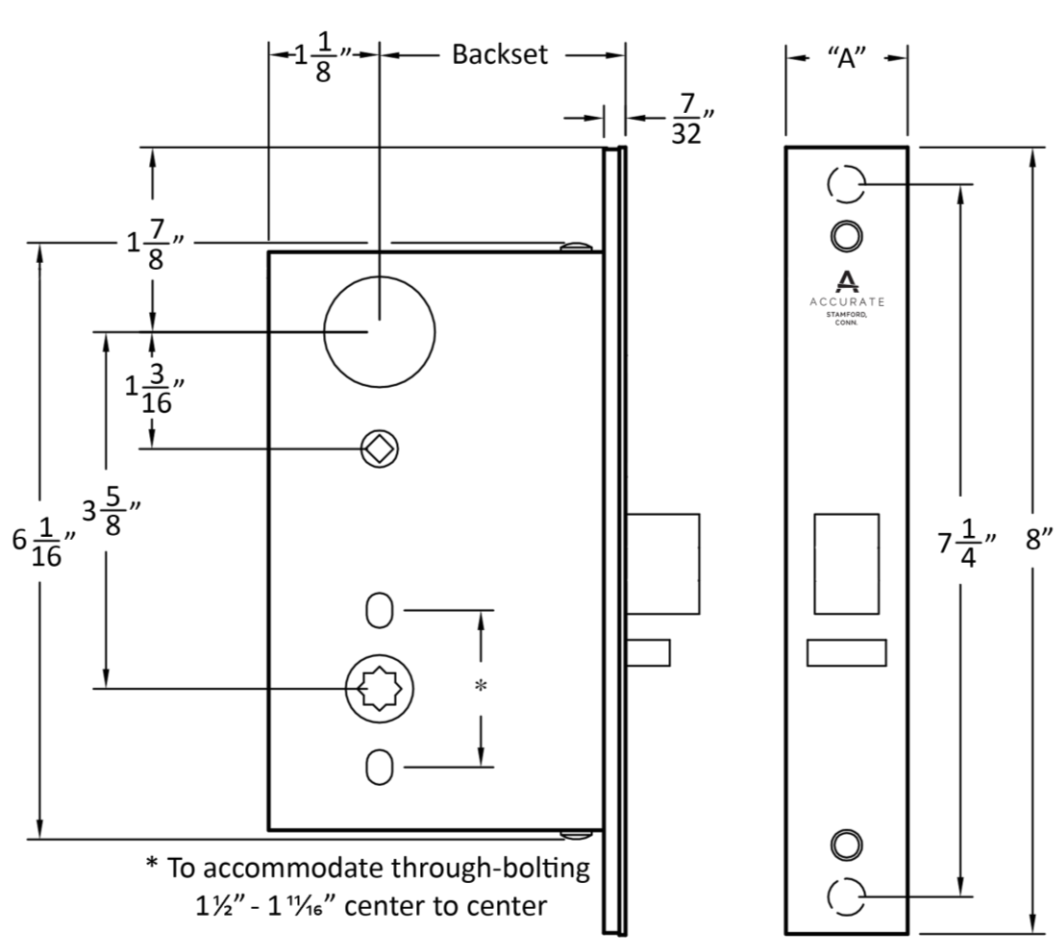

"A" 9100SEC - 1 1/4"
9000SEC - 1"

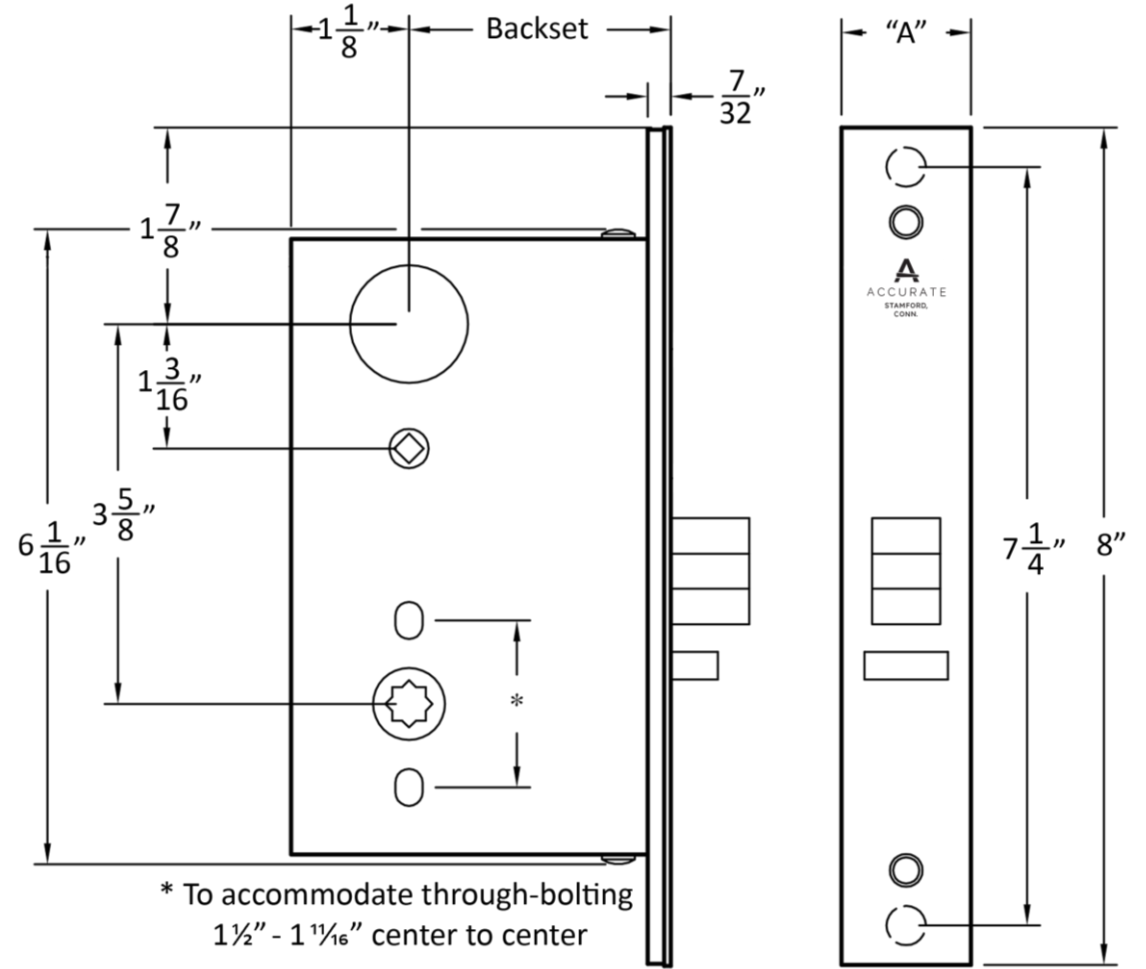

"A" 9100 Series - 1 1/4"
9000 Series - 1"

9100SEC FUNCTIONS

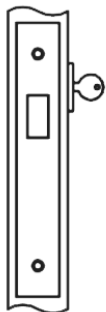

9101SEC (F18) DEADLOCK

Deadbolt by key outside, no inside operation.

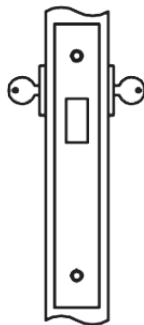

9102SEC (F16) DEADLOCK

Deadbolt by key either side.

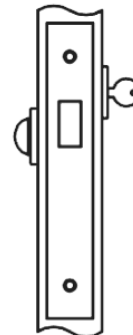

9103SEC (F17) DEADLOCK

Deadbolt by key outside and turn piece inside.



9104SEC DEADLOCK

Deadbolt by turn piece inside, no outside operation.

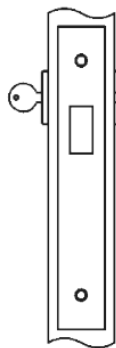

9105SEC DEADLOCK

Deadbolt by turn piece inside and emergency key outside.

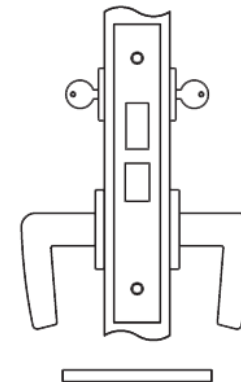

9122SEC (F14) STORE DOOR

Latch bolt by lever either side.

Deadbolt by key either side.

No emergency egress.

9100SEC FUNCTIONS

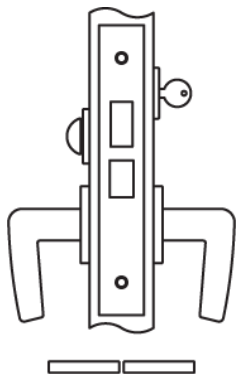

9124SEC (F13) DORMITORY, ENTRANCE OR STOREROOM

Latch bolt by lever either side.

Deadbolt by key outside and turn piece inside.

Turn of inside lever retracts latch and deadbolt simultaneously, automatically unlocking outside lever.

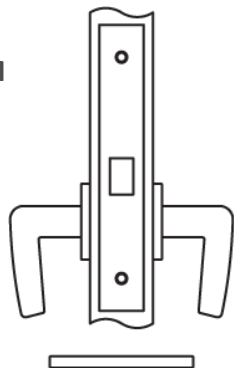

9125SEC (F01) PASSAGE

Latch bolt by lever either side.

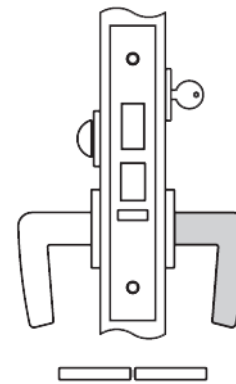

9134SEC (F15) HOTEL OR MOTEL

Latch bolt by lever and Guest or Master Key outside.

Outside lever always rigid.

Deadbolt by turn piece inside.

Turn of inside lever retracts latch and deadbolt simultaneously.

Auxiliary latch deadlocks latch bolt.

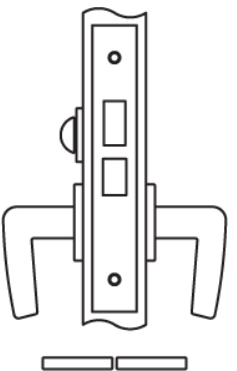

9139SEC (F19) PRIVACY BEDROOM OR BATHROOM

Latch bolt by lever either side.

Deadbolt by turn piece inside and optional emergency key outside.

Turn of inside lever retracts latch and deadbolt simultaneously, automatically unlocking outside lever.

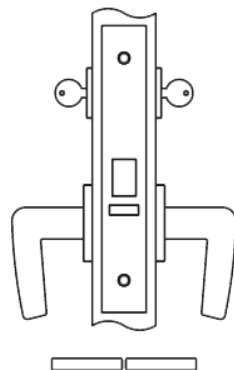

9142SEC (F09) ENTRANCE

Latch bolt by lever either side unless outside lever is locked by Master key from inside.

When outside lever is locked, latch bolt by key outside and lever inside.

Auxiliary latch deadlocks latch bolt.

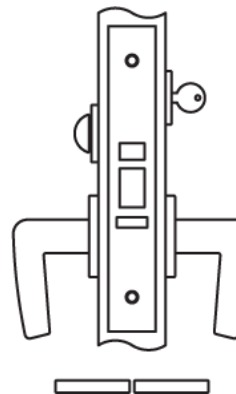

9143SEC INSTITUTIONAL PRIVACY

Latch bolt by lever either side unless outside lever is locked by thumb turn.

Thumb turn locks or unlocks outside lever.

Key locks or unlocks outside lever.

Key retracts latch as an independent function of the thumb turn to allow retraction if thumb turn is forcibly held in locked position.

Auxiliary latch deadlocks latch bolt.

Outside lever unlocks when inside lever is turned or door closes.

9100SEC FUNCTIONS

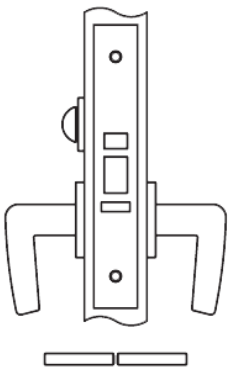

9143SEC-E INSTITUTIONAL PRIVACY – EMERGENCY RELEASE

Latch bolt by lever either side unless outside lever is locked by thumb turn.

Thumb turn locks or unlocks outside lever.

Emergency release locks or unlocks outside lever.

Auxiliary latch deadlocks latch bolt.

Outside lever unlocks when inside lever is turned or door closes.

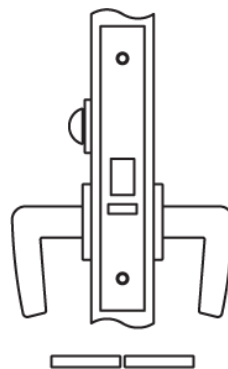

9144SEC-E INSTITUTIONAL PRIVACY – EMERGENCY RELEASE

Latch bolt by lever either side unless outside lever is locked by thumb turn.

Thumb turn locks or unlocks outside lever.

Emergency release locks or unlocks outside lever.

Auxiliary latch deadlocks latch bolt.

Outside lever unlocks when inside lever is turned (closing door will not unlock outside handle).

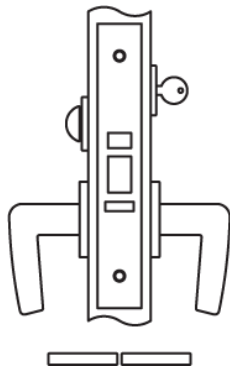

9143SEC-i INSTITUTIONAL PRIVACY – OCCUPANCY INDICATOR

Same operation as 9143 Institutional Privacy (specify Occupancy Indicator trim separately).

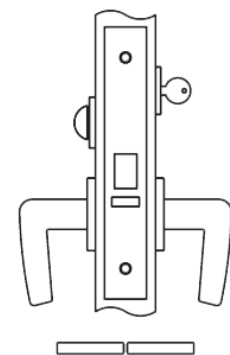

9144SEC-i INSTITUTIONAL PRIVACY - OCCUPANCY INDICATOR

Same operation as 9144 Institutional Privacy (specify Occupancy Indicator Trim separately).

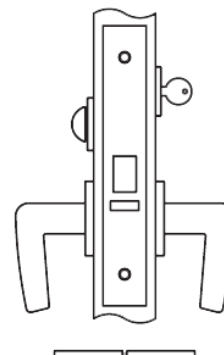

9144SEC INSTITUTIONAL PRIVACY

Latch bolt by lever either side unless outside lever is locked by thumb turn.

Thumb turn locks or unlocks outside lever.

Key locks or unlocks outside lever.

Key retracts latch as an independent function of the thumb turn to allow retraction if thumb turn is forcibly held in locked position.

Auxiliary latch deadlocks latch bolt.

Outside lever unlocks when inside lever is turned (closing door will not unlock outside lever).

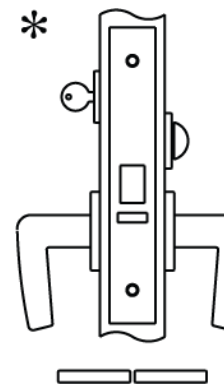

9144SEC-TO TIME-OUT

Latch retracted by lever either side unless outside thumb turn is rotated and held into position to temporarily lock inside lever.

When thumb turn is released by user, inside lever unlocks.

**Optional key inside retracts latch for emergency exit in case thumb turn is held locked by unauthorized person outside.*

9100SEC FUNCTIONS

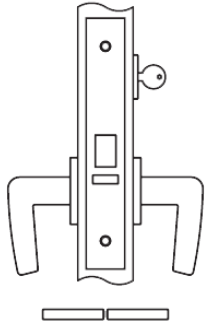

9145SEC CLASSROOM

Latch bolt by key outside and lever either side unless outside lever is locked by key.

Auxiliary latch deadlocks latch bolt.

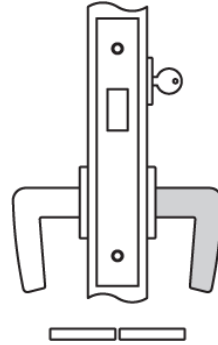

9145SEC-D CLASSROOM

Deadbolt by key outside.

Inside lever will retract deadbolt.

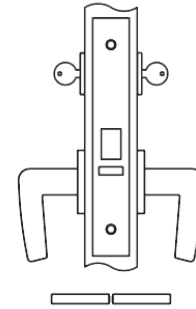

9145SEC-S CLASSROOM SECURITY

Latch bolt by lever either side unless outside lever is locked by key outside or inside.

When locked, latch bolt retracted by key either side or by lever inside.

Inside lever is always free.

Auxiliary latch deadlocks latch bolt.

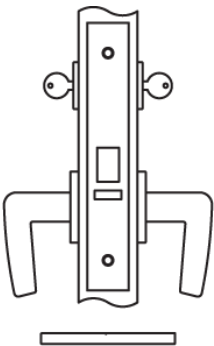

9146SEC CLASSROOM DOUBLE LOCKING

Latch bolt by key from either side.

Key from either side locks and unlocks outside and inside* levers.

Auxiliary latch deadlocks latch bolt.

**Verify code compliance before specifying this function.*

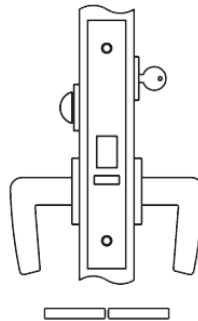

9153SEC (F04) ENTRANCE OR OFFICE

Latch bolt by key outside and lever either side unless outside lever is locked by thumb turn or key.

Key or thumb turn locks or unlocks outside lever.

Auxiliary latch deadlocks latch bolt.

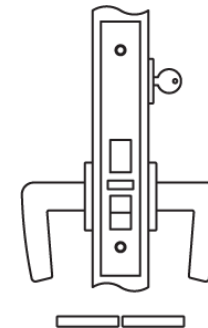

9156SEC (F04) ENTRANCE OR OFFICE

Latch bolt by key outside and lever either side unless outside lever is locked by toggle-action stop.

Auxiliary latch deadlocks latch bolt.

9100SEC FUNCTIONS

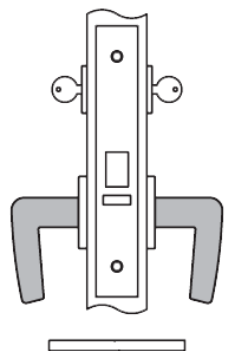

9158SEC (F30) INSTITUTION OR ASYLUM

Latch by key either side.

Inside* and outside handle is always RIGID.

Auxiliary latch deadlocks latch bolt.

**Verify code compliance before specifying this function.*

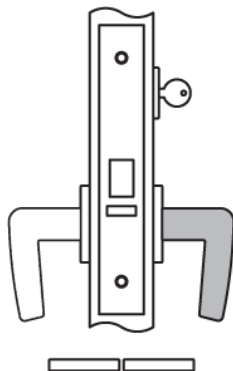

9159SEC (F07) STOREROOM OR CLOSET

Latch by lever inside and key outside.

Outside lever always rigid.

Auxiliary latch deadlocks latch bolt.

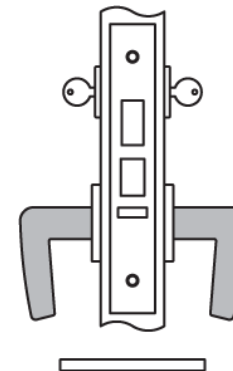

9160SEC ASYLUM WITH DEADBOLT

Latch by key either side.

Deadbolt by key either side (key projects deadbolt and retracts latch bolt and deadbolt).

Inside* and outside lever always rigid.

Auxiliary latch deadlocks latch bolt.

**Verify code compliance before using this function.*

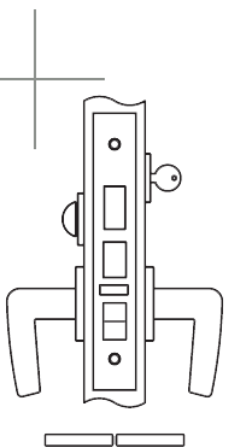

9167SEC (F20) ENTRANCE OR APARTMENT LOCK

Latch bolt by key outside and lever either side, unless outside lever is locked by toggle-action stop.

Deadbolt by key outside and turn piece inside.

Turning inside lever retracts latch and deadbolt simultaneously.

Outside lever remains locked until manually unlocked by toggle.

Auxiliary latch deadlocks latch bolt and prevents manipulation of locked toggle-action stop.

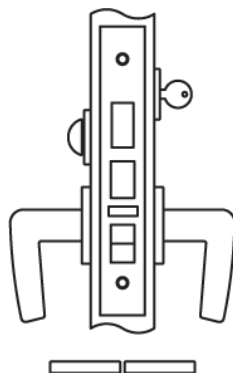

9169SEC ENTRANCE OR APARTMENT LOCK

Latch bolt by key outside and lever either side, unless outside lever is locked by toggle-action stop.

Deadbolt by key outside and turn piece inside.

Turning inside lever retracts latch and deadbolt simultaneously.

Outside lever remains unlocked until manually locked by toggle or projection of deadbolt.

Auxiliary latch deadlocks latch bolt and prevents manipulation of locked toggle-action stop.

M9 15XE-SEC TECHNICAL DETAILS

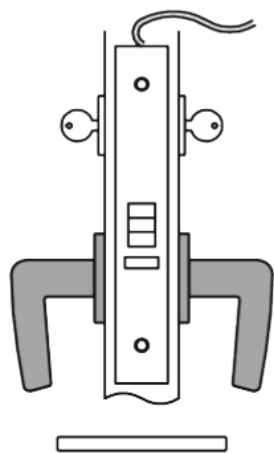

M9158E

Latch bolt by key either side.

Auxiliary latch deadlocks latch bolt.

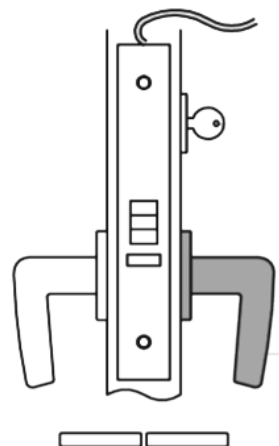

M9159E

Inside trim always free.

Latch bolt by key outside.

Auxiliary latch deadlocks latch bolt.

M9058E/M9059E for doors $1\frac{3}{8}$ minimum ($1\frac{1}{4}$ " armor front)

M9158E/M9159E for doors $1\frac{3}{4}$ minimum (1" armor front)

UL Listed 3 Hour (Mechanics and Electronics)

Grade 1 Certified to ANSI/BHMA A156.13.2005 Standard

FAIL SECURE OPERATION*: Inside and outside trim unlocked when power is applied and locked when power is removed.

FAIL SAFE OPERATION: Inside and outside trim locked when power is applied and unlocked when power is removed. Lockset will unlock in the event of power failure.

BACKSETS: $2\frac{1}{2}$ " , $2\frac{3}{4}$ " , $3\frac{3}{4}$ " , 5" or 6"

OPERATION: Key Cylinder (by others) will override electronics to retract latch bolt

12-24V AC/DC (10.8V-26.4V Operating Range)

250mA MAX Inrush

10mA MAX Holding

Non-polarized Leads

*Lock is furnished as FAIL SECURE.

Cutting the yellow wire loop changes lock to FAIL SAFE after cycling power once.

M915XE-SEC MONITORING FUNCTIONS

AE - AUTHORIZED EGRESS

Also referred to as REQUEST TO EXIT (or REX switch), monitors the activation of the inside trim “when lockset is in the locked position only”.

ELECTRICAL SPECIFICATIONS:

SPDT Mechanical switch

| Voltage | Current |
|---------|---------|
| 125 VAC | 3 AMP |
| 30 VDC | 2 AMP |

AM – DEAD LATCH MONITORING

Monitors the auxiliary latch. To activate switch the lockset must be in the closed position with the auxiliary latch depressed and main latch extended.

ELECTRICAL SPECIFICATIONS:

SPDT Mechanical switch

| Voltage | Current |
|---------|---------|
| 125 VAC | 3 AMP |
| 30 VDC | 2 AMP |

LM – LATCH BOLT MONITORING

Monitors the full extension of the main latch

ELECTRICAL SPECIFICATIONS:

SPDT Mechanical switch

| Voltage | Current |
|---------|---------|
| 125 VAC | 3 AMP |
| 30 VDC | 2 AMP |

LB – LOCKING BAR MONITORING

Monitors the position of the locking bar function of the lockset.

ELECTRICAL SPECIFICATIONS:

SPDT Mechanical switch

| Voltage | Current |
|---------|---------|
| 125 VAC | 3 AMP |
| 30 VDC | 2 AMP |

M915XE-SEC MONITORING FUNCTIONS

SM – SECURITY MONITORING

A combination of AM and LB, SM monitors IN SERIES* the status of the locking bar (locked or unlocked position) and the status of the auxiliary latch (dead latch position).

Lockset must be locked with the main latch extended and the auxiliary latch depressed to get a secure signal. If any of the conditions are not met, lockset goes into an unsecure mode.

ELECTRICAL SPECIFICATIONS:

2 each SPDT Mechanical switches wired in series

| Voltage | Current |
|----------------|----------------|
|----------------|----------------|

| | |
|---------|-------|
| 125 VAC | 3 AMP |
|---------|-------|

| | |
|--------|-------|
| 30 VDC | 2 AMP |
|--------|-------|

** If independent monitoring is required (not in series), please specify as SM2*

DPS – DOOR POSITION MONITORING

CLOSED LOOP SECURE

When the door is secure (closed position), the monitor switch shows a contact closed state. When the door opens (unsecure position), an open contact is detected as an alarm.

OPEN LOOP SECURE

When the door is secure (closed position), the monitor switch contacts are open. When the door opens (unsecure position), a closed contact is detected as an alarm.

ELECTRICAL SPECIFICATIONS:

SPDT Magnetic Reed switch (activation magnet mounted behind the ANSI strike)

| Voltage | Current |
|----------------|----------------|
|----------------|----------------|

| | |
|--------|------|
| 28 VDC | .3 A |
|--------|------|

M915XE-SEC MONITORING FUNCTIONS

LPF – LOCK OUT PRIVACY MONITORING

For FAIL SECURE locks only: One switch monitors safe side thumb turn hub. Engaging safe side turn piece disables remote access control unlocking (keypad or card reader) or scheduled unlock.

APPLICATIONS:

Enhanced security in office buildings after hours, SCIF/rooms housing sensitive information and opening subject to authorized access on a temporary basis.

Enhanced privacy in commercial buildings (for shared staff showers, restrooms, office, etc.) or for private residences with multiple service provider access (e.g. lock-out during vacation or need to immediately lock out specific user until system updates).

INSTITUTIONAL TRIM

ALL DESIGNS ARE THROUGH BOLTED [CONCEALED FASTENERS AVAILABLE].

FEATURES:

- Levers meet ADA A117.1 Accessibility Code
- Levers feature two-point attachment for high security openings
- Lever return to face of door (no gap) to prevent fire hose entanglement
- Custom trim designs to retrofit doors per specification



SK SAFETY KNOB

Not ADA compliant.
Available for functions with a deadbolt.

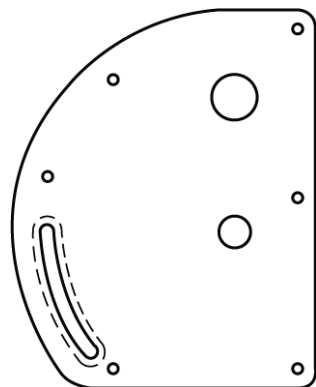

R ESCUTCHEON

Latch plate for retrofit and additional physical security.
1/4" (6mm) stainless steel.
2 pt. lever attachment.
Function will determine what features are added: turn piece, cylinder, indicators, etc.
Available trim combinations: RB, RC, RSK.



B LEVER DESIGN

3/4" (19mm) round solid bar stock.
2 3/8" projection.



C LEVER DESIGN

3/4" (19mm) round solid bar stock.
2 3/8" projection.

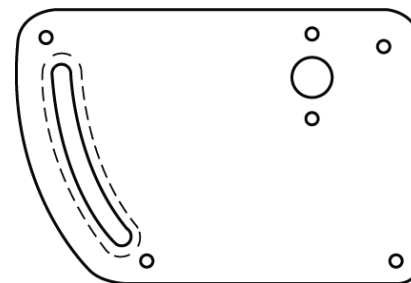

H ESCUTCHEON (SECTIONAL)

1/4" (6mm) stainless steel.
2 pt. lever attachment.
Sectional trim: turn piece, cylinder, indicators, etc. to be specified separately (e.g. ALT-ADA-P thumb turn).
Available trim combinations: HB, HC, HSK.

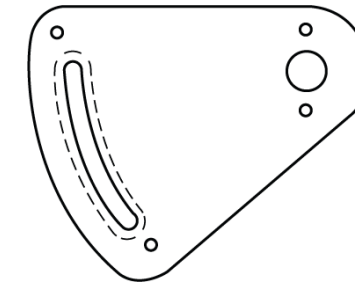

E ESCUTCHEON (SECTIONAL)

1/4" (6mm) stainless steel.
2 pt. lever attachment.
Sectional trim: turn piece, cylinder, indicators, etc. to be specified separately.
Available trim combinations: EB, EC, ESK.

BEHAVIORAL HEALTHCARE TRIM

ALL DESIGNS ARE THROUGH BOLTED [CONCEALED FASTENERS AVAILABLE].



CP-S



CP-C

With cylinder cutout



CP-B

Blank



ALT-ADA-P

For use with Accurate Institutional Privacy Locks (e.g. 9144SEC)



ALT-ADA-D

For use with deadlocks (e.g. 9101SEC)



HORIZONTAL CRESCENT HANDLE (HCH)

For details, please refer to <https://www.antiligature accuratelockandhardware.com/>

Accurate Lever Trim

18L LEVER

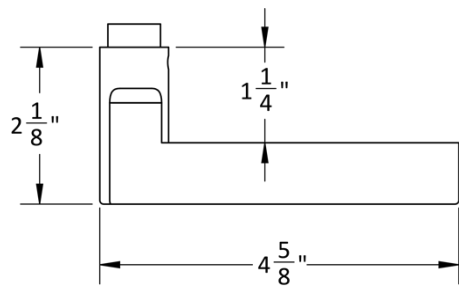

19L LEVER

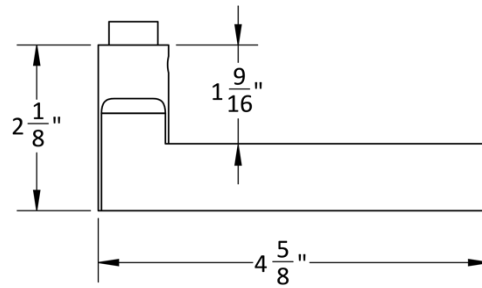

20L LEVER

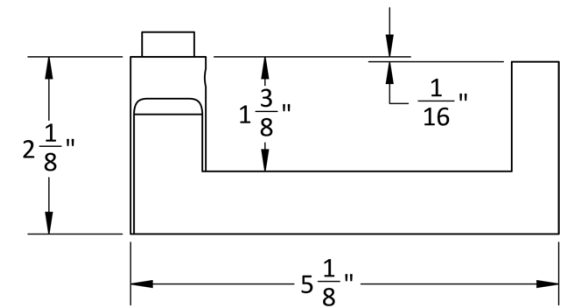

Accurate Lever Trim

21L LEVER

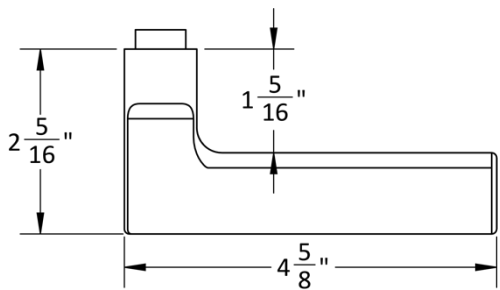

29L LEVER

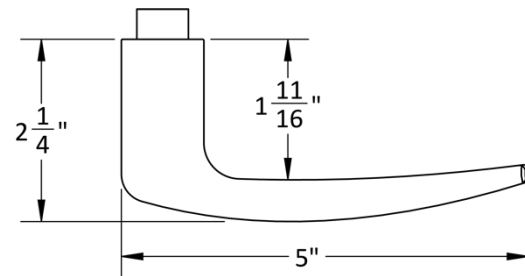

39L LEVER

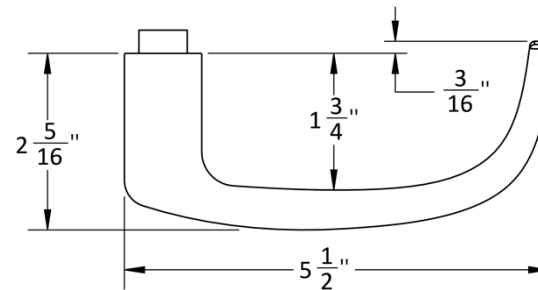

72L LEVER

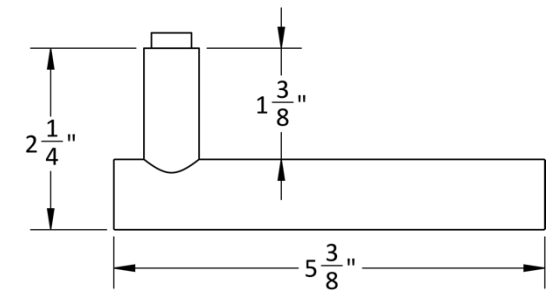

ACCURATE ROSE OPTIONS

1R ROSE

Front



Side

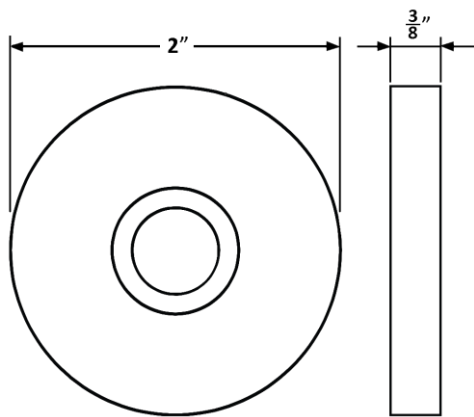

2R ROSE

Side



Inside



Outside

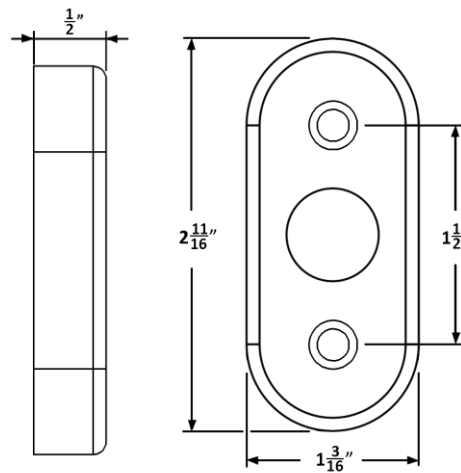

4R ROSE

Side



Inside



Outside

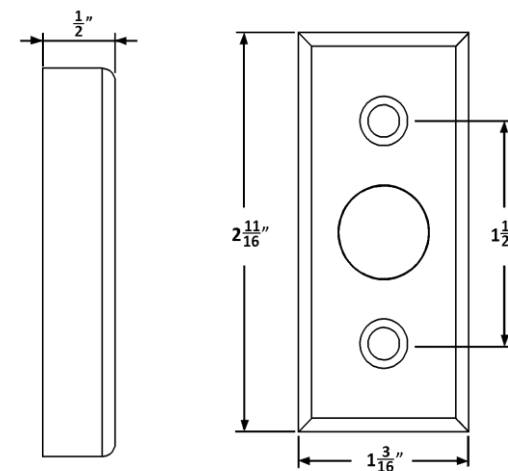

ACCURATE ESCUTCHEON OPTIONS

COMBINATIONS DEPEND ON FUNCTION

1E-B
Blank

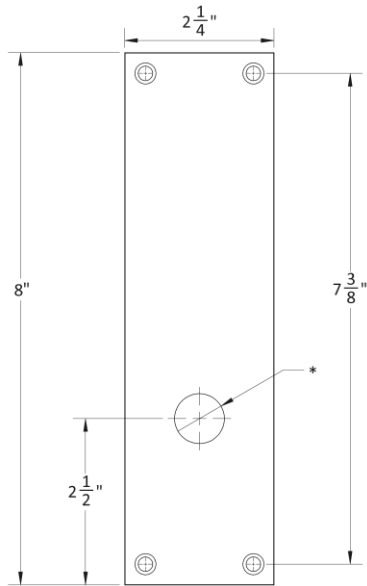

* Dimensions may vary depending on trim

1E-C
Cylinder Cutout

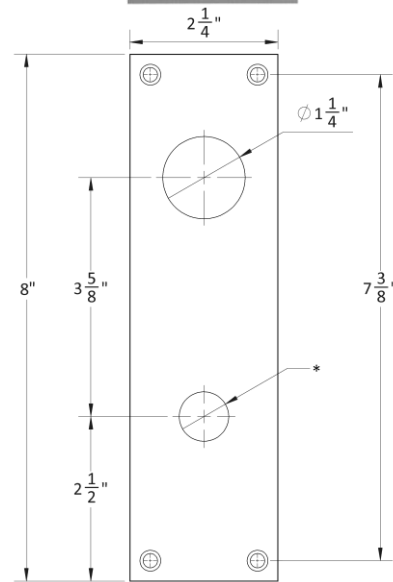

* Dimensions may vary depending on trim

1E-Ci
Cylinder Cutout with Indicator

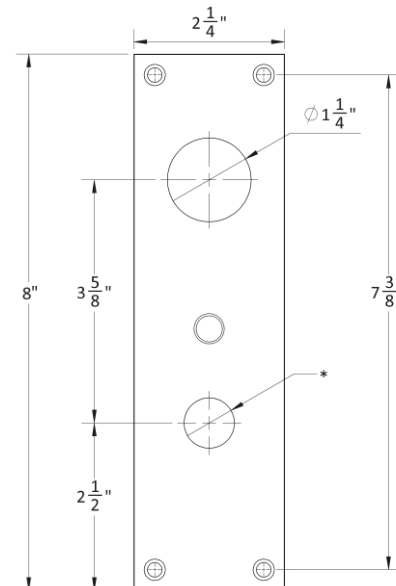

* Dimensions may vary depending on trim

1E-T
Thumb Turn

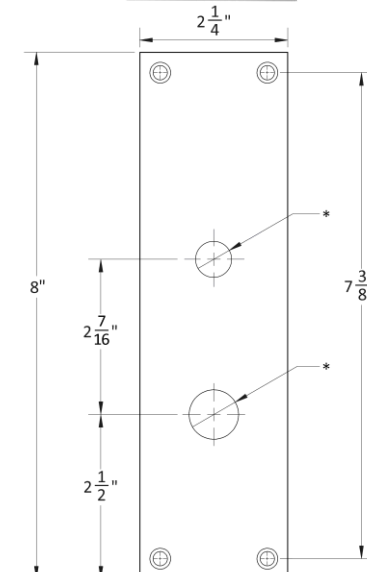

* Dimensions may vary depending on trim

1E-E
Emergency Release

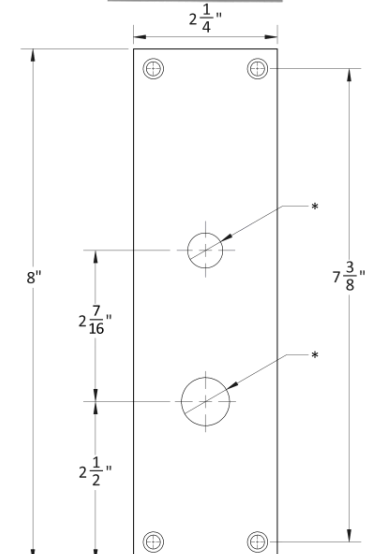

* Dimensions may vary depending on trim

HOW TO SPECIFY

HANDING

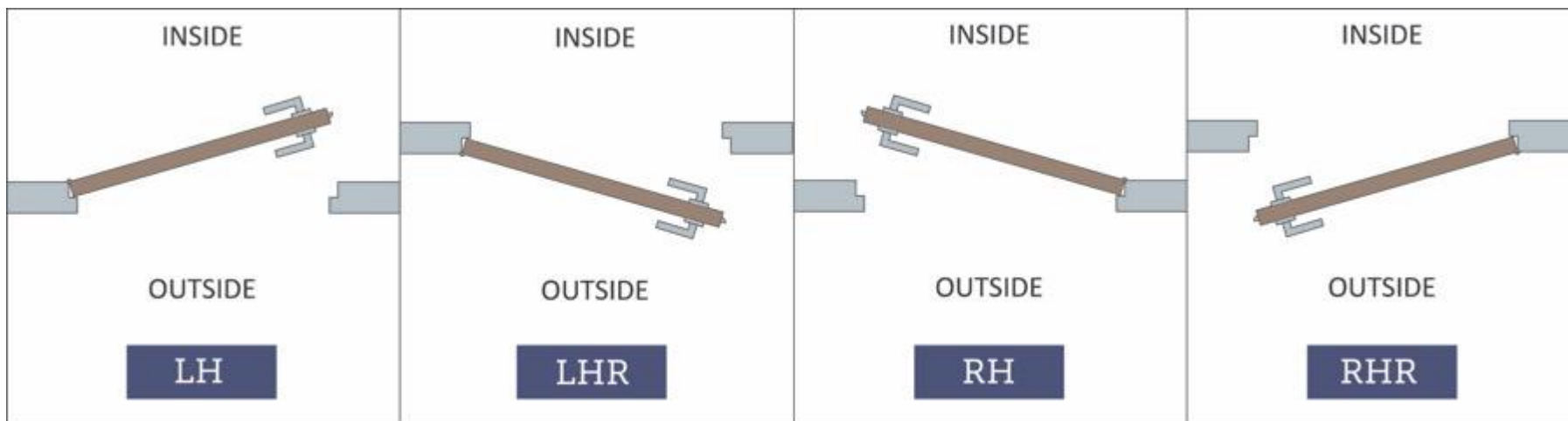

FINISHES

GROUP 1: US4, US4NL, US32D*, US26D

GROUP 2: US3, US3NL, US26, US32*, US10B, US14, US15, US19

GROUP 3: BN, BB, TN, TB, DURO, ESN, US15A, US5

* Trim options (including Accurate levers) may not be available in US32D, US32, US9, or US10 finish. Please call for assistance.

To view example of finishes visit: [Accurate Finishes](#).

HOW TO SPECIFY

FUNCTION.**FINISH**.DOORTHICKNESS.**HAND**.TRIM

Functions

See available functions (pg. 5-13)

Finishes

See available finishes pg. 19

Trim

Accurate trim or other manufacturers' sectional (rose) Trim (specify hub size or brand)*

Configurations:

- LxL, KxK, Custom TPxK or Custom TPxL where applicable (call for assistance)

EXAMPLES

Institutional Privacy Lock | Accurate Trim

E.g.: 9143SEC.**US32D**.134.**RH**.RB.8mm

Institution or Asylum Lock | Accurate Trim

E.g.: 9158SEC.**US26D**.134.**LH**.ESK

Institutional Privacy with Occupancy Indicator | Accurate Trim

E.g.: 9143SEC-i.**US32D**.214.**RH**.CH

Entrance or Apartment Lock | Accurate Trim

E.g.: 9167SEC.**US19**.214.**LH**.18L X 1R

High Security Strike:

The security strike is standard with the lockset at no additional charge.

A reinforced latching strike plate fortifies the opening to prevent kick-in type burglaries. A solid machined steel plate is secured by four individual three-inch steel screws that reach into the opening's studded framing. Normal strikes typically fasten to the door finish trim only when combined with the 9100SEC, a reinforced strike plate adds solid protection to the most vulnerable part of the door opening.

**ACCURATE LOCK & HARDWARE
MANUFACTURERS OF CUSTOM LOCKS
AND ARCHITECTURAL HARDWARE**

1 Annie Place | Stamford, CT 06902

P: 203.348.8865

F: 203.348.5234

E: sales@accuratelockandhardware.com

www.accuratelockandhardware.com



AMERICAN CRAFTED
— SINCE 1972 —