

SILENT **PAC**TM
by ACCURATE

**QUIET
LOCK**

Reduce Disturbance From Door Noise.
Dramatically.

THE COMPLETE QUIET PACKAGE: 9100Q QUIET LOCK + LEVER DAMPENING DISC

SILENT **PAC**™ by ACCURATE



Reduce disturbance from door noise. Dramatically.

SilentPac™ by Accurate is a suite of acoustically engineered door hardware designed to soften noise from opening and closing doors, ultimately resulting in more peaceful and quiet environments.



REDUCE NOISE UP TO 16X

Experience ultra quiet environments



SIMPLE INSTALLATION

Ideal for both new doors and retrofit applications



MAINTAIN AESTHETICS

Designed to be compatible with most other brands' hardware for maximum flexibility



| ACCURATE LOCK SERIES | ADD SilentPac™ LEVER DAMPENING DISC (SP) | DESCRIPTION |
|----------------------|--|---|
| 9100Q | X | Complete Quiet Package 9100Q Quiet Lock with SilentPac™ Lever Dampening Disc |
| 9100Q | | Quiet Lock with No Lever Dampening Disc |
| 9100 | X | Regular 9100 lock with Lever Dampening Disc |
| 8500 | X | 8500 Lock with Lever Dampening Disc |
| 8800 | X | 8800 Lock with Lever Dampening Disc |
| 9500 | X | 9500 Lock with Lever Dampening Disc |
| 9800 | X | 9800 Lock with Lever Dampening Disc |
| 8800ML | X | 8800 Magnetic Latch with Lever Dampening Disc |
| 9100ML | X | 9100 Magnetic Latch with Lever Dampening Disc |
| 9500ML | X | Quietest Interior Mortise Set 9500 Magnetic Latch with Lever Dampening Disc |
| 9800ML | X | Quietest Interior Mortise Set 9800 Magnetic Latch with Lever Dampening Disc |
| 2002Q | | 2002CPDL Pocket Door Lock with Integrated Quiet Edge Pull |
| 2000Q | | 2000 Pocket Door Quiet Edge Pull |
| 2002CPDP-Q | | 2002CPDP Pocket Door Quiet Edge Pull |
| 2002CPDS-Q | | 2002CPDS Pocket Door Strike with Integrated Quiet Edge Pull |



THE COMPLETE QUIET PACKAGE

SILENT **PAC**[™]
by ACCURATE

QUIET
LOCK

SILENT **PAC**[™]
by ACCURATE

LEVER
DAMPENING DISC

The Complete Quiet Package

9100Q Quiet Lock + Lever Dampening Disc

SILENTPAC™
ACCURATE

LEVER
DAMPENING DISC

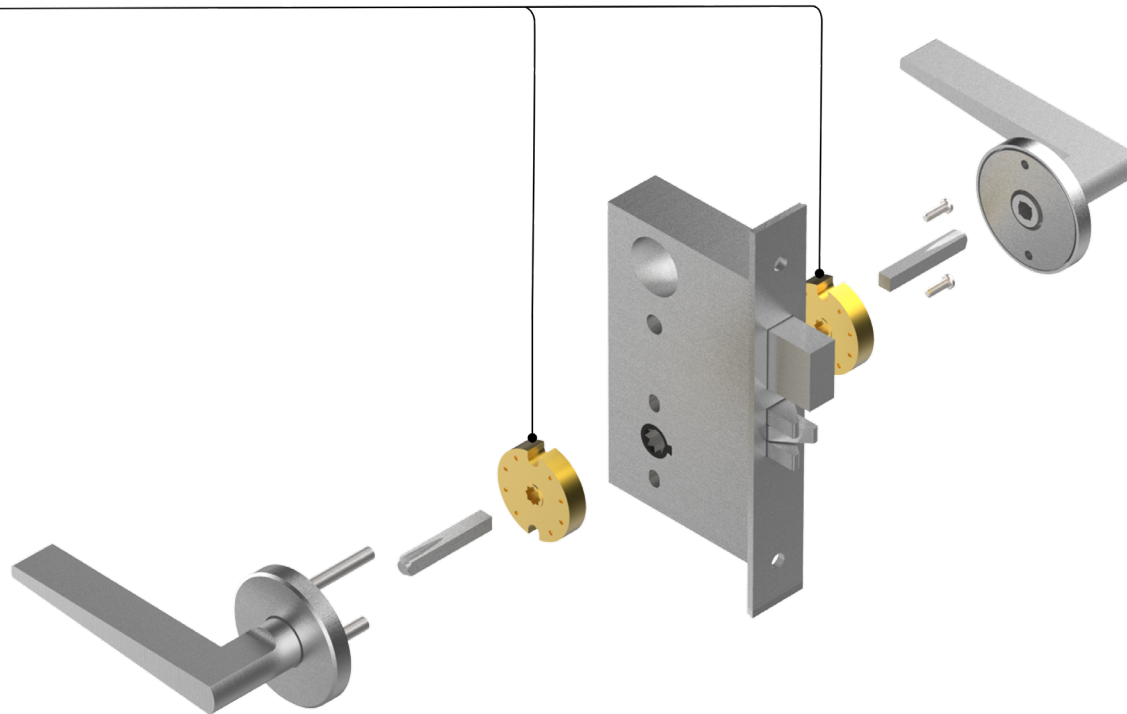

Lever Dampening Disc Dimensions

Diameter: $1\frac{3}{4}$ "

Thickness: $\frac{13}{32}$ "

Through-bolting: $1\frac{1}{2}$ " – $1\frac{11}{16}$ " OC

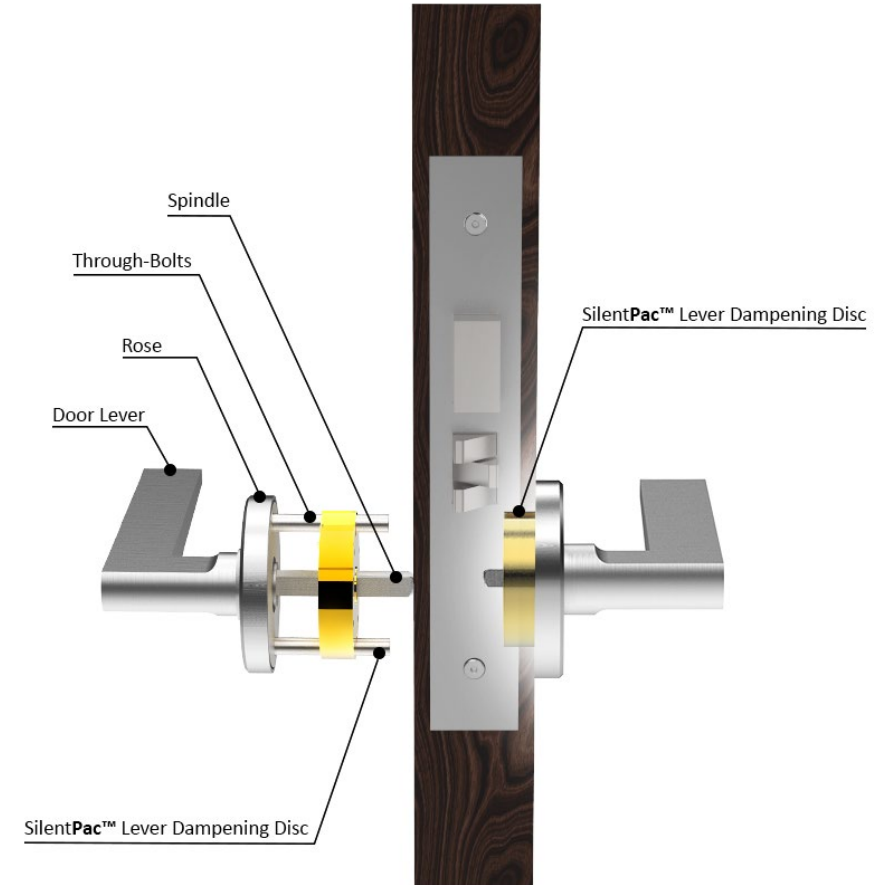

Shown here with 9139Q Privacy Lock that requires a split spindle and 2 SilentPac™ Lever Dampening Discs.

The Complete Quiet Package

9100Q Quiet Lock + Lever Dampening Disc

TECHNICAL DETAILS

- Functions at 55 decibels, 16x decibel reduction compared to standard Grade 1 mortise locks
- UL Listed 3 Hour (R134846)
- Grade 1 certified to ANSI/BHMA A156.13.2005
- Insulated lock body features noise muffling for lower decibel reduction
- Cushioned Latch bolt: softens noise common to latch firing into strike
- For doors with stiles 4" and greater
- Available in upside down configuration (lever/knob high)
- Simple installation for retrofit or new doors
- Patent-pending

Understanding Decibel Levels

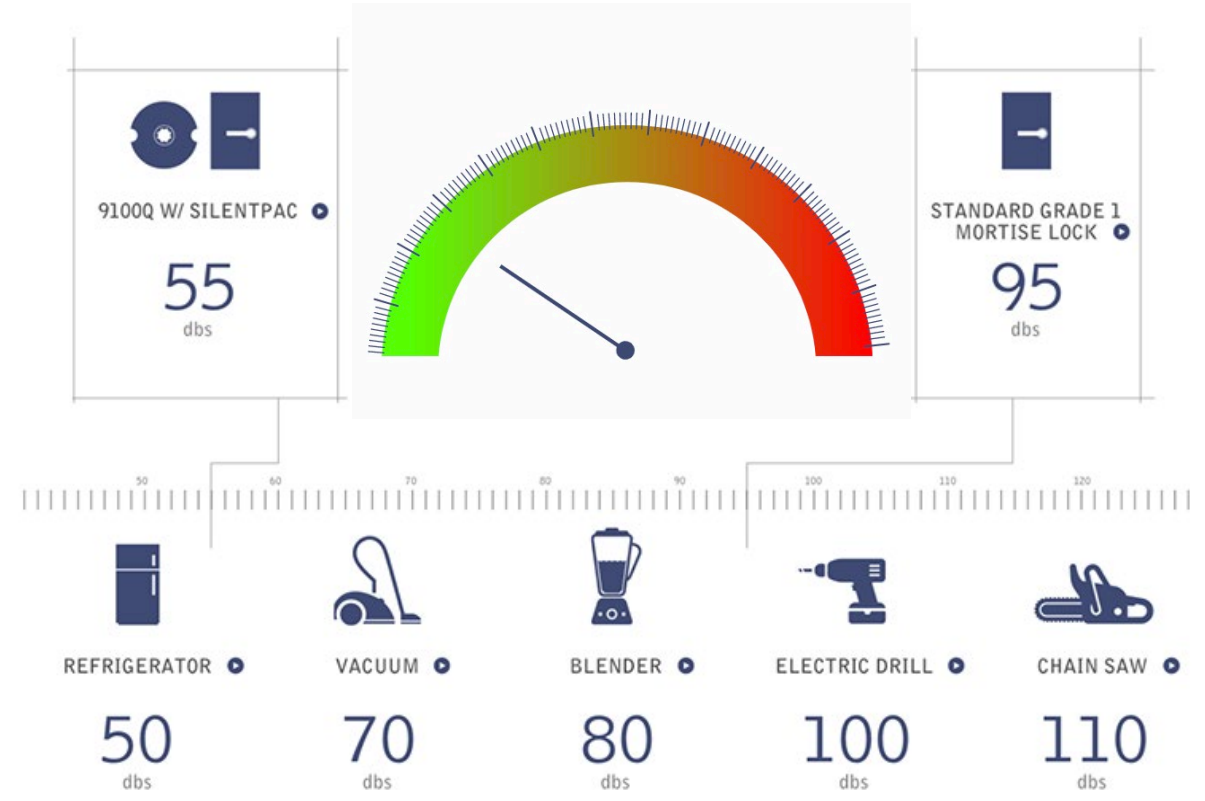

EXPERIENCE THE DIFFERENCE

Open the door to quieter environments. See and hear how SilentPac™ Solutions operate compared to standard door hardware.

www.silentpacsolutions.com



ACCURATE LOCK SERIES COMPATIBILITY

- 9100Q
- 9100
- 8500/8800
- 8800ML
- 9100ML
- 9500ML/9800ML

MORTISE LOCK COMPATIBILITY

Compatible with most through-bolted mortise locks

- Accurate
- Corbin Russwin
- Sargent
- Schlage

TRIM COMPATIBILITY

Please call for availability of additional trim options.

- Accurate Levers
- Baldwin
- Corbin Russwin
- Classic Brass
- FSB
- Schlage

Functions: SilentPac™ Quiet Lock 9100Q

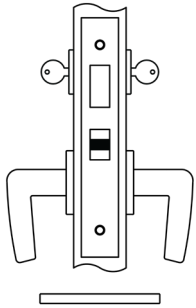

9122Q STORE DOOR

Latch bolt by lever either side.

Deadbolt by key either side.

No emergency egress.

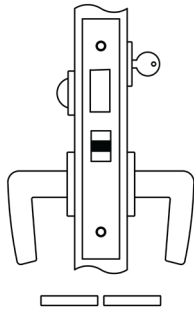

9124Q DORMITORY

Latch bolt by lever either side.

Deadbolt by key outside, thumbturn inside.

A turn of the inside lever retracts latch and deadbolt simultaneously, automatically unlocking outside lever.

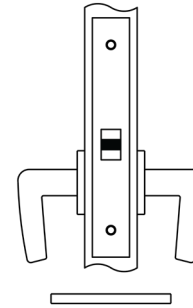

9125Q PASSAGE

Latch bolt by lever either side.

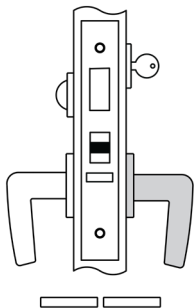

9134Q HOTEL

Latch bolt by lever inside and key outside.
Outside lever always rigid.

Deadbolt by thumbturn inside.

A turn of inside lever retracts latch and deadbolt simultaneously, automatically unlocking outside lever.

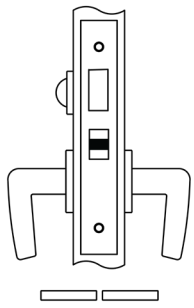

9139Q PRIVACY

Latch bolt by lever either side.

Deadbolt by thumbturn and optional emergency coin turn outside.

A turn of inside lever retracts latch and deadbolt simultaneously.

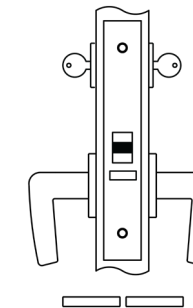

9142Q ENTRANCE OR PUBLIC RESTROOM

Latch bolt by lever either side unless outside lever is locked by Master Key from inside.

When outside lever is locked, latch bolt by key outside and lever inside.

Auxiliary latch deadlocks latch bolt.

Note: 9100ADL Active Dummy Lock Function is not available with the 9100Q lock, however it is compatible with the Lever Dampening Disc

Functions: SilentPac™ Quiet Lock 9100Q

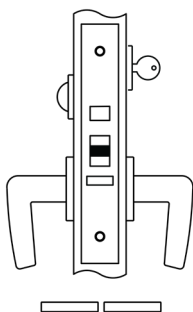

9143Q INSTITUTIONAL PRIVACY

Latch bolt by lever either side unless outside lever is locked by thumb turn.
 Thumb turn locks or unlocks outside lever.
 Key locks or unlocks outside lever.
 Key retracts latch as an independent function of the thumb turn to allow retraction if thumb turn is forcibly held in locked position.
 Auxiliary latch deadlocks latch bolt.
 Outside lever unlocks when inside lever is turned **or** door closes.

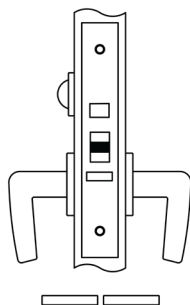

9143EQ INSTITUTIONAL PRIVACY EMERGENCY RELEASE

Latch bolt by lever either side unless outside lever is locked by thumb turn.
 Thumb turn locks or unlocks outside lever.
 Emergency release locks or unlocks outside lever.
 Auxiliary latch deadlocks latch bolt.
 Outside lever unlocks when inside lever is turned **or** door closes.

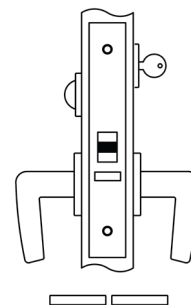

9144Q INSTITUTIONAL PRIVACY

Latch bolt by lever either side unless outside lever is locked by thumb turn.
 Thumb turn locks or unlocks outside lever.
 Key locks or unlocks outside lever.
 Key retracts latch as an independent function of the thumb turn to allow retraction if thumb turn is forcibly held in locked position.
 Auxiliary latch deadlocks latch bolt.
 Outside lever unlocks when inside lever is turned (closing door will not unlock outside lever).

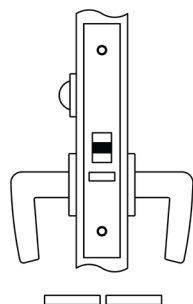

9144EQ INSTITUTIONAL PRIVACY EMERGENCY RELEASE

Latch bolt by lever either side unless outside lever is locked by thumb turn.
 Thumb turn locks or unlocks outside lever.
 Emergency release locks or unlocks outside lever.
 Auxiliary latch deadlocks latch bolt.
 Outside lever unlocks when inside lever is turned (closing door will not unlock outside lever).

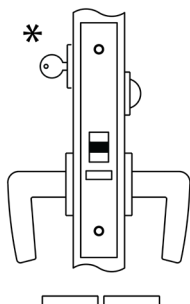

9144TOQ TIME-OUT

Latch retracted by lever either side unless outside thumb turn is rotated and held into position to temporarily lock inside lever.
 When thumb turn is released by user, inside lever unlocks.

*Optional key inside retracts latch for emergency exit in case t-turn is held by unauthorized person outside.

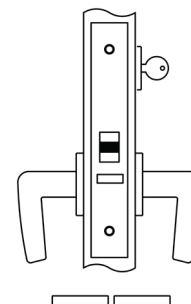

9145Q CLASSROOM

Latch bolt by key outside and lever either side unless outside lever is locked by key.
 Auxiliary latch deadlocks latch bolt.

Functions: SilentPac™ Quiet Lock 9100Q

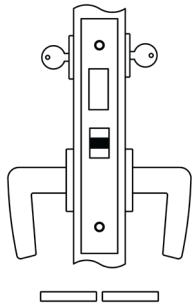

9145SQ CLASSROOM SECURITY

Latch bolt by lever either side unless outside lever is locked by key outside or inside.

When locked, latch bolt retracted by key inside or outside or lever inside.

Inside lever is always free.

Auxiliary latch deadlocks latch bolt.

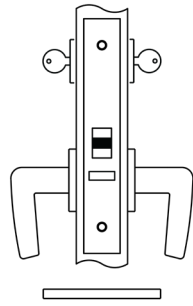

9146Q CLASSROOM DOUBLE LOCKING

Latch bolt by key from either side.

Key from either side locks and unlocks outside **and** inside* levers.

Auxiliary latch deadlocks latch bolt.

**Inside lever is not always free. Verify code compliance before using this function.*

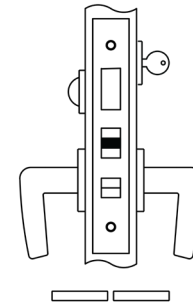

9148Q ENTRANCE

Latch bolt by key outside and lever either side unless outside lever is locked by toggle action stop.

Deadbolt by key outside and turn piece inside.

Turning inside lever retracts latch and deadbolt simultaneously.

Outside lever remains locked until manually unlocked by toggle.

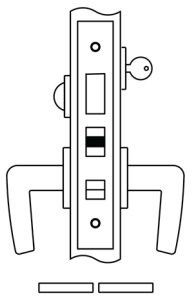

9149Q ENTRANCE

Latch bolt by key outside and lever either side unless outside lever is locked by toggle action stop.

Deadbolt by key outside and turn piece inside.

Turning inside lever retracts latch and deadbolt simultaneously.

Outside lever remains unlocked until manually locked by toggle or projection of deadbolt.

Note: Function not offered on thumb grip x thumb grip applications.

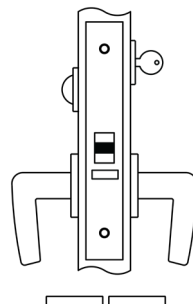

9153Q ENTRANCE

Latch bolt by key outside and lever either side unless outside lever is locked by thumb turn or key.

Key or thumb turn locks or unlocks outside lever.

Auxiliary latch deadlocks latch bolt.

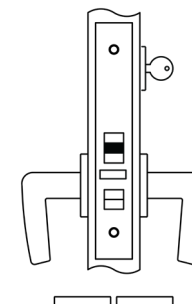

9156Q ENTRANCE OR OFFICE

Latch bolt by key outside and lever either side unless outside lever is locked by toggle action stop.

Auxiliary latch deadlocks latch bolt.

Functions: SilentPac™ Quiet Lock 9100Q

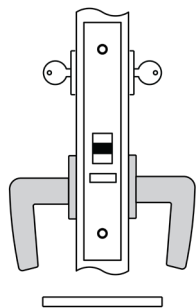

9158Q INSTITUTIONAL OR ASYLUM

Latch by key either side.

Inside* and outside lever always **rigid**.

Auxiliary latch deadlocks latch bolt.

**Verify code compliance before using this function.*

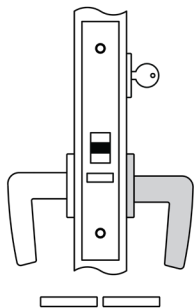

9159Q STOREROOM

Latch by lever inside and key outside.

Outside lever always **rigid**.

Auxiliary latch deadlocks latch bolt.

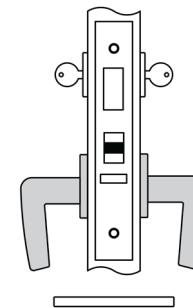

9160Q ASYLUM WITH DEADBOLT

Latch by key either side.

Deadbolt by key either side (key projects deadbolt and retracts latch bolt and deadbolt).

Inside* and outside handle always **rigid**.

Auxiliary latch deadlocks latch bolt.

**Verify code compliance before using this function.*

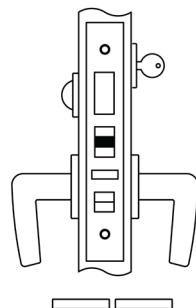

9167Q ENTRANCE

Latch bolt by key outside and lever either side, unless outside lever is locked by toggle-action stop.

Deadbolt by key outside and turn piece inside.

Turning inside lever retracts latch and deadbolt simultaneously.

Outside lever remains locked until manually unlocked by toggle.

Auxiliary latch dead locks latch bolt and prevents manipulation of locked toggle-action stop.

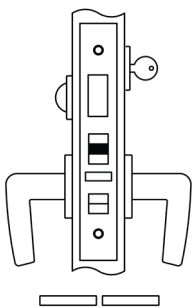

9169Q ENTRANCE

Latch bolt by key outside and lever either side, unless outside lever is locked by toggle-action stop.

Deadbolt by key outside and turn piece inside. Turning inside lever retracts latch and deadbolt simultaneously.

Outside lever remains unlocked until manually locked by toggle or projection of deadbolt.

Auxiliary latch dead locks latch bolt and prevents manipulation of locked toggle-action stop.

**Function not offered on thumb grip x thumb grip applications.*

Accurate Lever Trim

18L LEVER

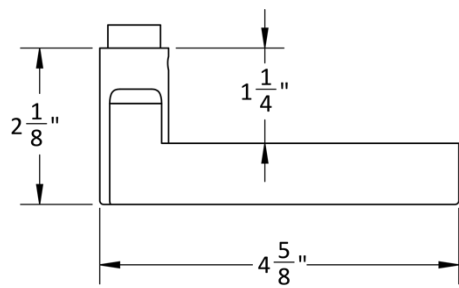

19L LEVER

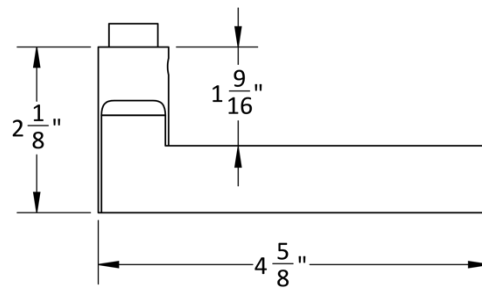

20L LEVER

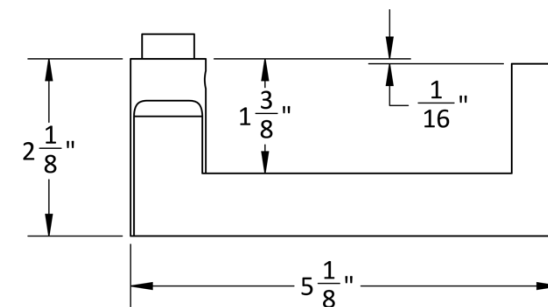
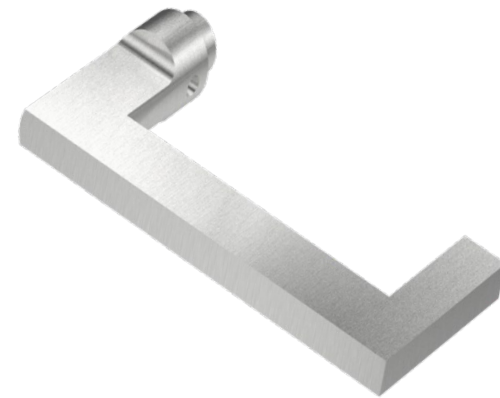

Accurate Lever Trim

21L LEVER

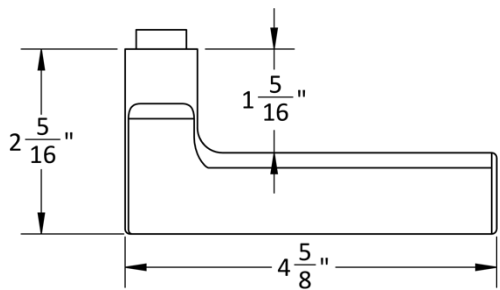

29L LEVER

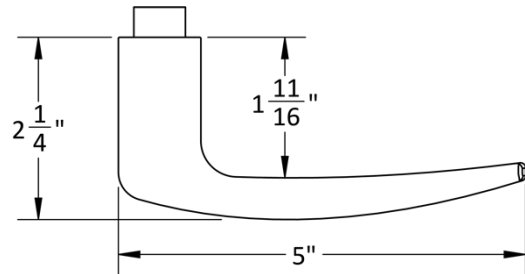

39L LEVER

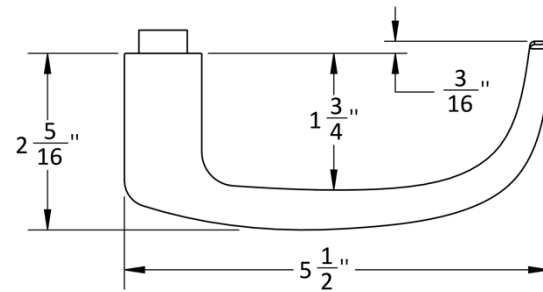

72L LEVER

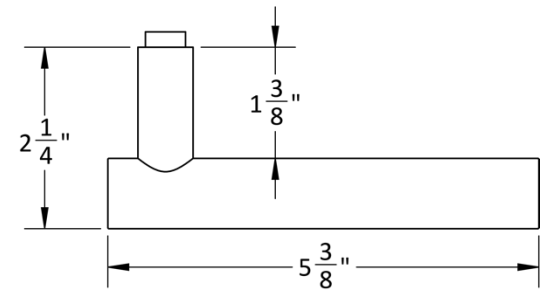

Accurate Rose Options

Compatible with All Accurate Levers

1R ROSE

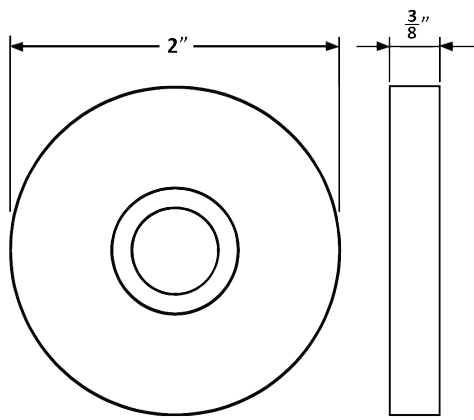
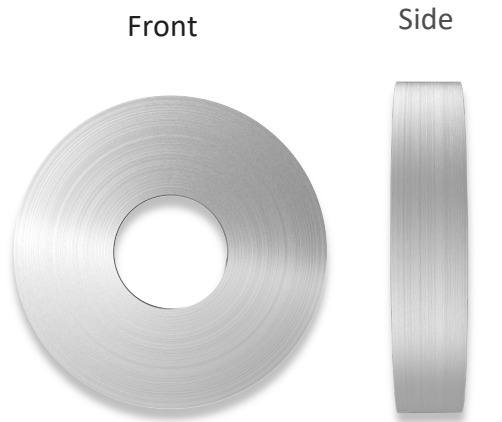

2R ROSE*

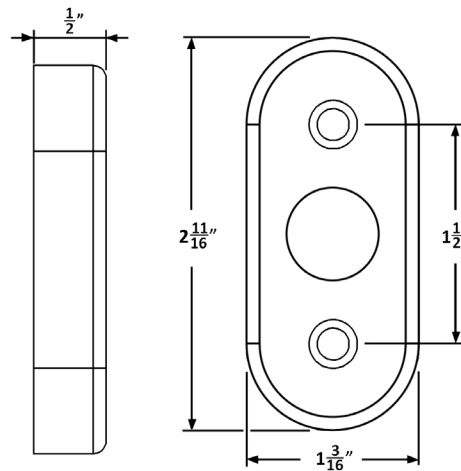
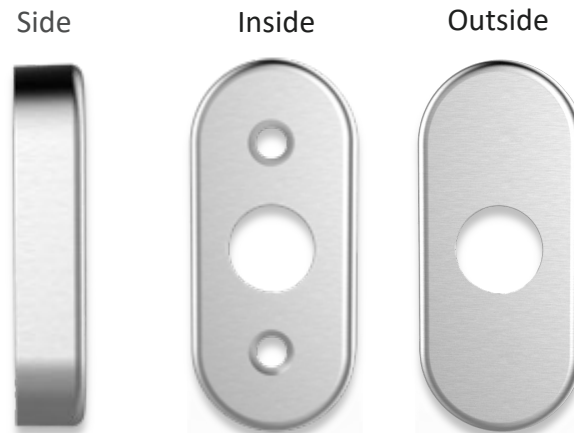

4R ROSE*

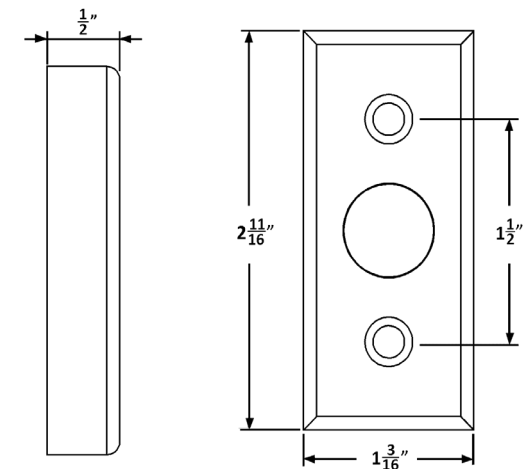
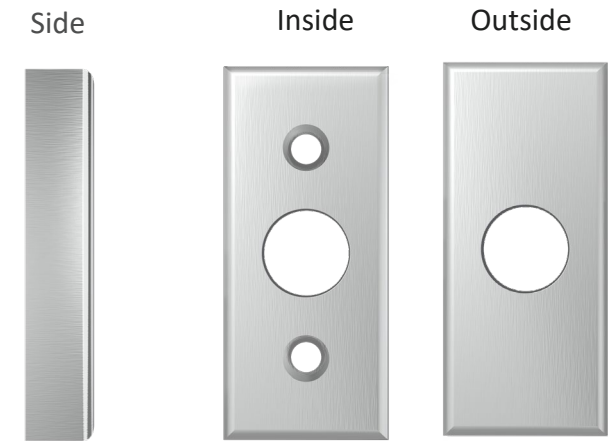

***2R + 4R Roses is not compatible with SilentPac™ Lever Dampening Disc
Escutcheon options also available based on lock function.**

HOW TO SPECIFY

HANDING

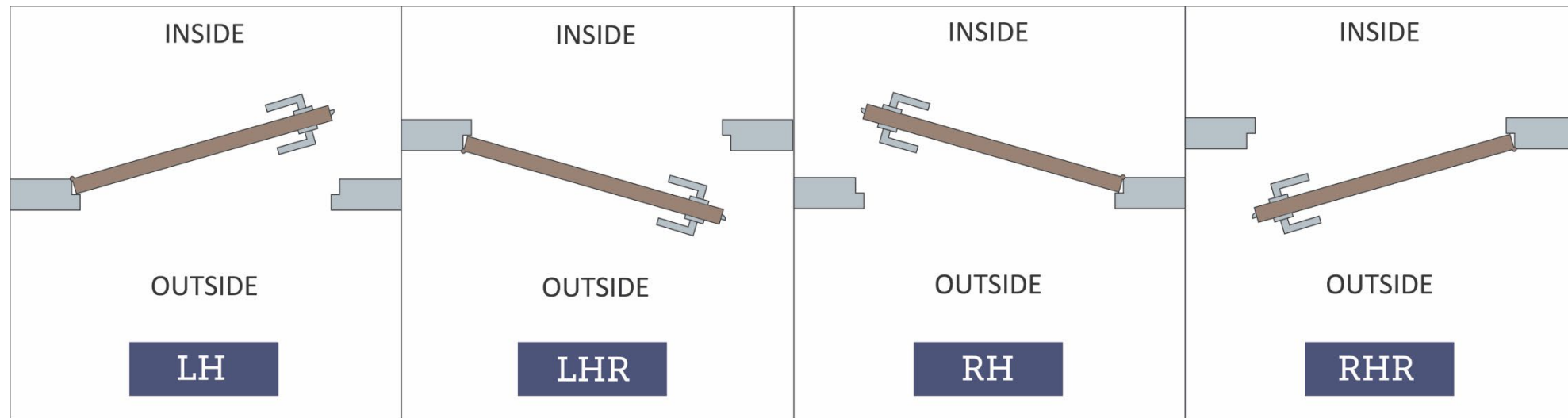

FINISHES

GROUP 1: US4, US4NL, US32D*, US26D

GROUP 2: US3, US3NL, US26, US32*, US9*, US10*, US10B, US14, US15, US19

GROUP 3: BN, BB, TN, TB, DURO, ESN, US15A, US5

* Trim options (including Accurate levers) may not be available in US32D, US32, US9, or US10 finish. Please call for assistance.

To view example of finishes visit: [Accurate Finishes](#).

CYLINDERS & KEYING

9100Q Series accepts any standard American mortise cylinder. For details on required cams and compatibility with other manufacturers' cylinders, please visit: [Accurate Support](#).

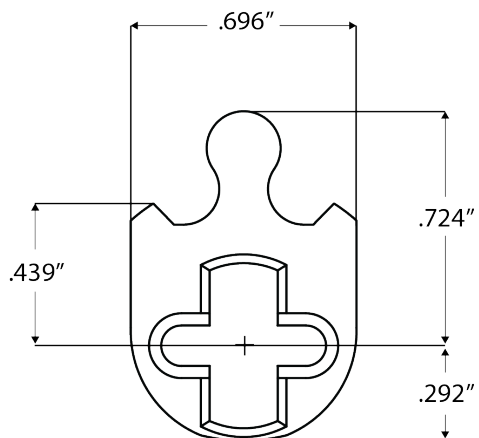

HOW TO SPECIFY

FUNCTION.SP.BACKSET.TRIM.FINISH.HAND.DOORTHICKNESS

Functions

- See available functions (pg. 8-11)
- Some functions available with occupancy indicator (i)
- Specify indicator trim separately

SilentPac™ Lever
Dampening Disc

Available Backsets:

2¹/₂" , 2³/₄"
3³/₄" , 5" , 6"

Finishes

See available finishes
pg.14

Example Trim Options:

- Accurate Lever Trim
 - Accurate Crescent Trim
 - Other Manufacturers' Trim
- (Verify compatibility on pg. 3, please call for assistance)

Configurations:

- LxL, KxK, KxL, TPxK,, TPxL, TPxTP
- (Not all configurations compatible with SilentPac™ Lever Dampening Disc)

Hub Size:

- Specify hub size or architectural hardware brand lever/knob

EXAMPLES

Accurate 9100Q | NO SilentPac™ | Other Manufacturers' Trim
(SilentPac™ not yet available for use with Sargent trim)

E.g. 9125Q.234.SARGENT TRIM.US32D.RH.134

Accurate 9100Q | SilentPac™ | Accurate Lever Trim with Rose

E.g. 9139Q.SP.234.18L/1R.US26.LH.214

Accurate 9100Q | SilentPac™ | Accurate Crescent Trim with Indicator

E.g. CH 9145Qi.SP.234.US26D.RH.134

Accurate 9100Q | SilentPac™ | Accurate Lever with Escutcheon and Indicator

E.g. 9124Qi.SP.234.19L/1E.US32D.RH.134

Accurate 9100Q | NO SilentPac™ | Thumb Press x Lever, 8mm Spindle
(Other Manufacturers' Trim)

E.g. 9148Q.212.TPxL.8mm.US26.LH.134

**ACCURATE LOCK & HARDWARE
MANUFACTURERS OF LOCKS AND
CUSTOM ARCHITECTURAL HARDWARE**

1 Annie Place | Stamford, CT 06902

P: 203.348.8865

F: 203.348.5234

E: sales@accuratelockandhardware.com

www.silentpacsolutions.com

www.accuratelockandhardware.com

