



ACCURATE

LOCK & HARDWARE

AMERICAN CRAFTED SINCE 1972

G87 SERIES

GLASS PATCH MORTISE SETS FOR SWINGING DOORS



G87 SERIES GLASS PATCH MORTISE SETS

NEW | ANTI-FRICTION LATCH BOLT

The G87 Series Glass Patch Mortise Set allows for a contemporary open-space design that can inspire more transparency, versatility, and efficiency in the workplace. This sleek design can be easily installed to fit the standard ½” tempered glass and is compatible with various door designs and configurations as well. The new, upgraded anti-friction latch results in smoother operation. The G87 is offered as a complete package including lock body, thumb turn (emergency release where applicable), patch assembly, and levers.

NEW ANTI-FRICTION LATCH BOLT
Furnished Standard as of August 1, 2021

G87 Series

GLASS PATCH MORTISE SETS FOR SWINGING DOORS

- Available centered on glass (G87) or [offset on glass \(GO87\)](#)
- Offered as a complete package including lock body, thumb turn (emergency release when applicable), patch assembly and levers
- New Anti-Friction Latch Bolt for smoother operation and improved performance (furnished standard as of August 1, 2021)
- Standard set up is for 2" backset onto $\frac{1}{2}$ " thick tempered glass
- Custom options available including: other backsets, other door thicknesses, custom anodized aluminum finishes/colors



G87 GLASS PATCH WITH G87-GPS STRIKE
(strike specified and sold separately)

G87 Series Functions

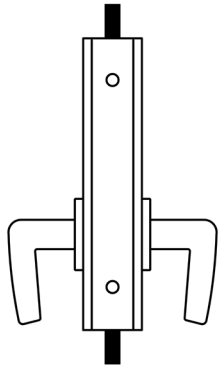

**G8700ADL
ACTIVE DUMMY LOCK**

Active handles inside and out.

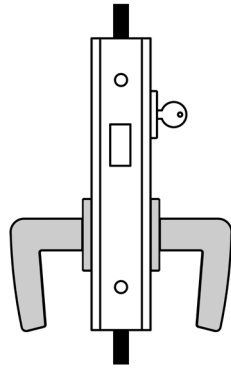

**G8701
DEADLOCK**

Deadbolt by key outside, no inside operation.

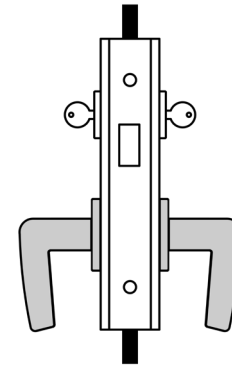

**G8702
DEADLOCK**

Deadbolt by key either side.

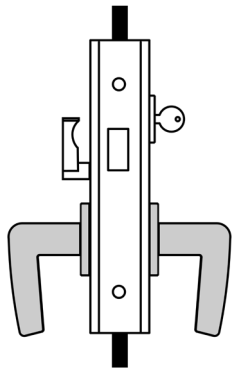

**G8703
DEADLOCK**

Deadbolt by key outside, thumb turn inside.

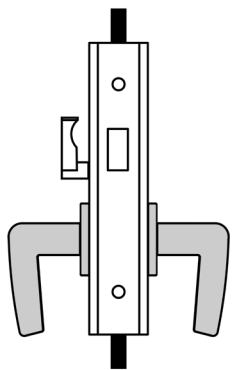

**G8704
DEADLOCK**

Deadbolt by thumb turn inside only.

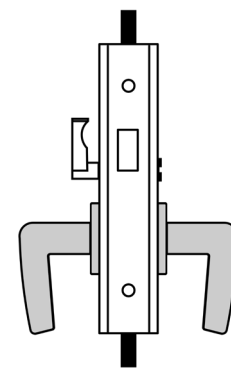

**G8705
DEADLOCK**

Deadbolt by emergency release outside, thumb turn inside.

G87 Functions

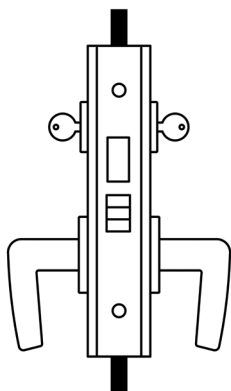

G8722 STORE DOOR

Latch bolt by lever either side.

Deadbolt by key either side.

No emergency egress.

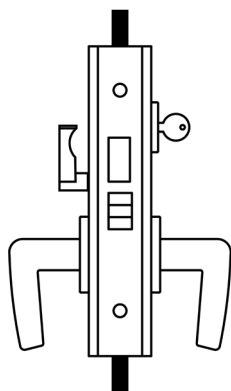

G8724 DORMITORY

Latch bolt by lever either side.

Deadbolt by key outside, thumb turn inside.

A turn of the inside lever retracts latch and deadbolt simultaneously, automatically unlocking outside lever.

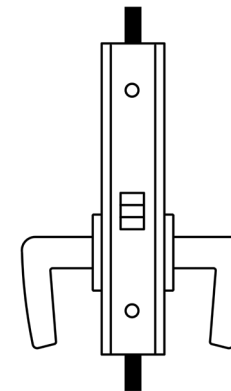

G8725 PASSAGE

Latch bolt by lever either side.

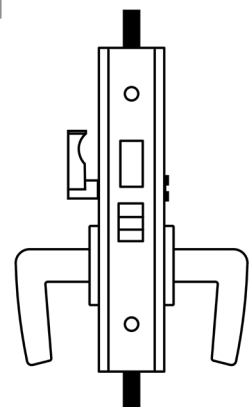

G8739 PRIVACY

Latch bolt by lever either side.

Deadbolt by thumb turn and optional emergency coin turn outside.

A turn of inside lever retracts latch and deadbolt simultaneously.

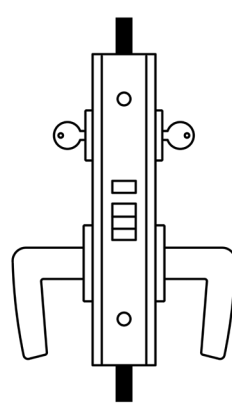

G8742 ENTRANCE

Latch bolt by lever either side unless outside lever is locked by Master Key from inside.

When outside lever is locked, latch bolt by key outside and lever inside.

Auxiliary latch deadlocks latch bolt.

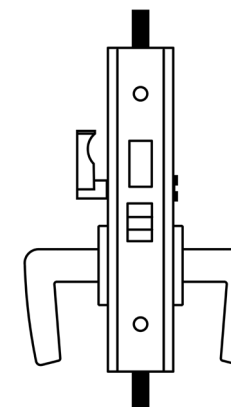

G8745 CLASSROOM

Latch bolt by key outside and lever either side unless outside lever is locked by key.

Auxiliary latch deadlocks latch bolt.

G87 Functions

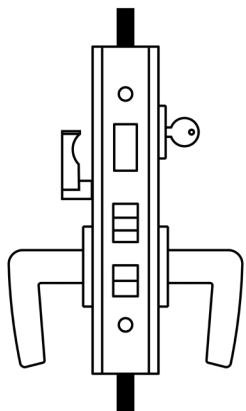

G8748 ENTRANCE

Latch bolt by key outside and lever either side unless outside lever is locked by toggle action stop.

Deadbolt by key outside and turn piece inside.

Turning inside lever retracts latch and deadbolt simultaneously.

Outside lever remains locked until manually unlocked by toggle.

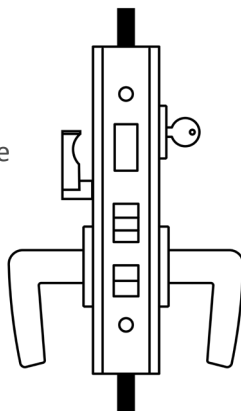

G8749 ENTRANCE

Latch bolt by key outside and lever either side unless outside lever is locked by toggle action stop.

Deadbolt by key outside and turn piece inside.

Turning inside lever retracts latch and deadbolt simultaneously.

Outside lever remains unlocked until manually locked by toggle or projection of deadbolt.

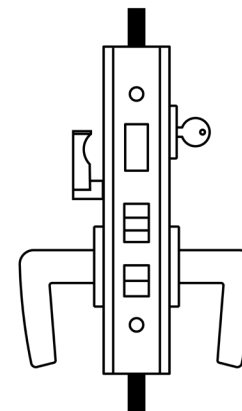

G8756 ENTRANCE OR OFFICE

Latch bolt by key outside and lever either side unless outside lever is locked by toggle-action stop.

Auxiliary latch deadlocks latch bolt.

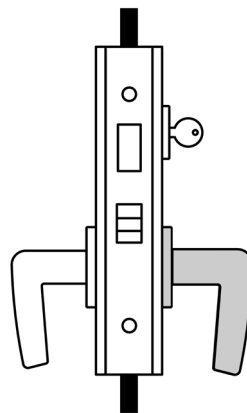

G8759 STOREROOM

Latch by lever inside and key outside.

Outside lever always rigid.

Auxiliary latch deadlocks latch bolt.

G87 Centered on Glass Patch Dimensions

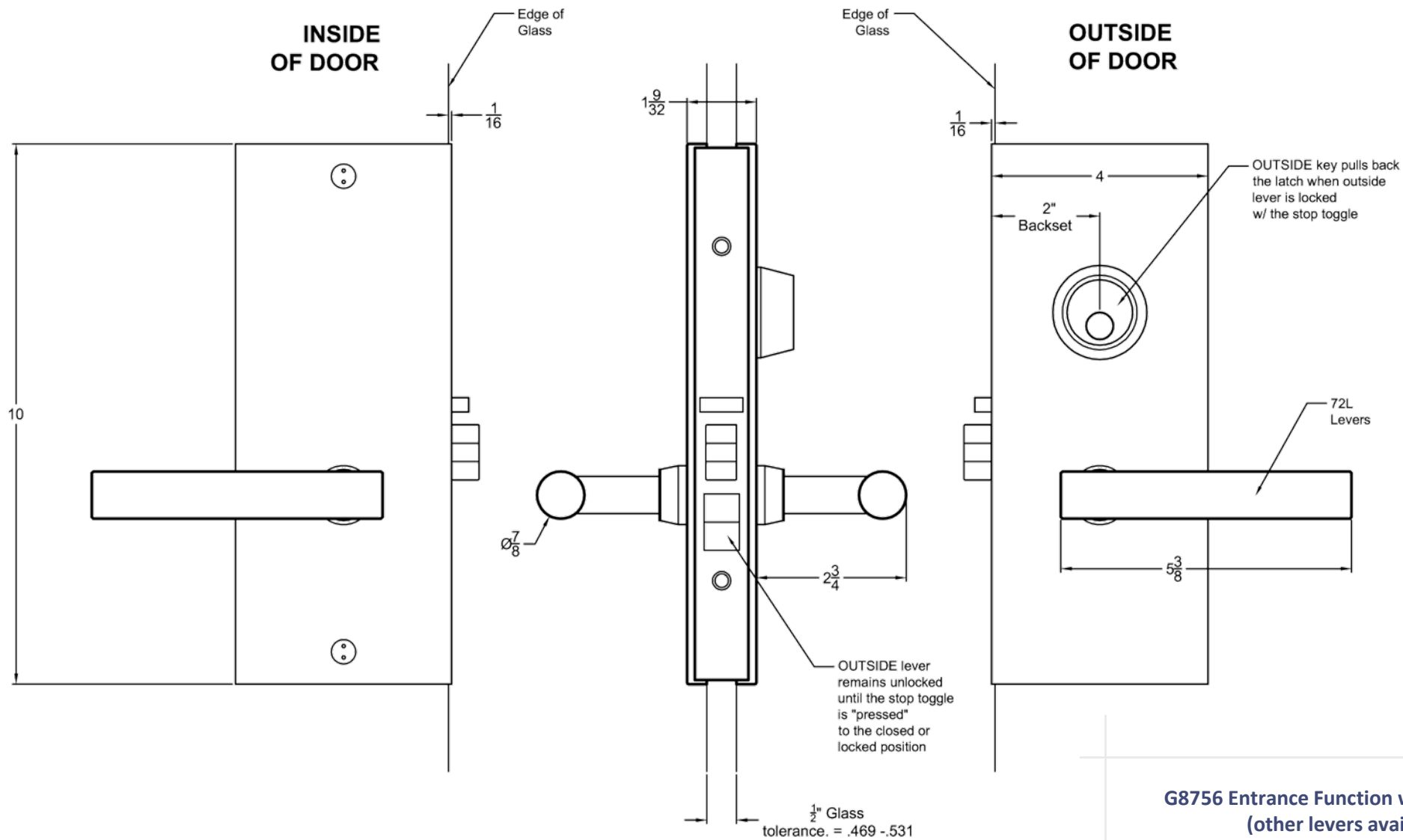
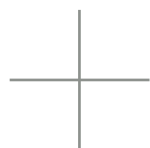

G8756 Entrance Function with 72L Levers (other levers available)



GPS Glass Patch Strike

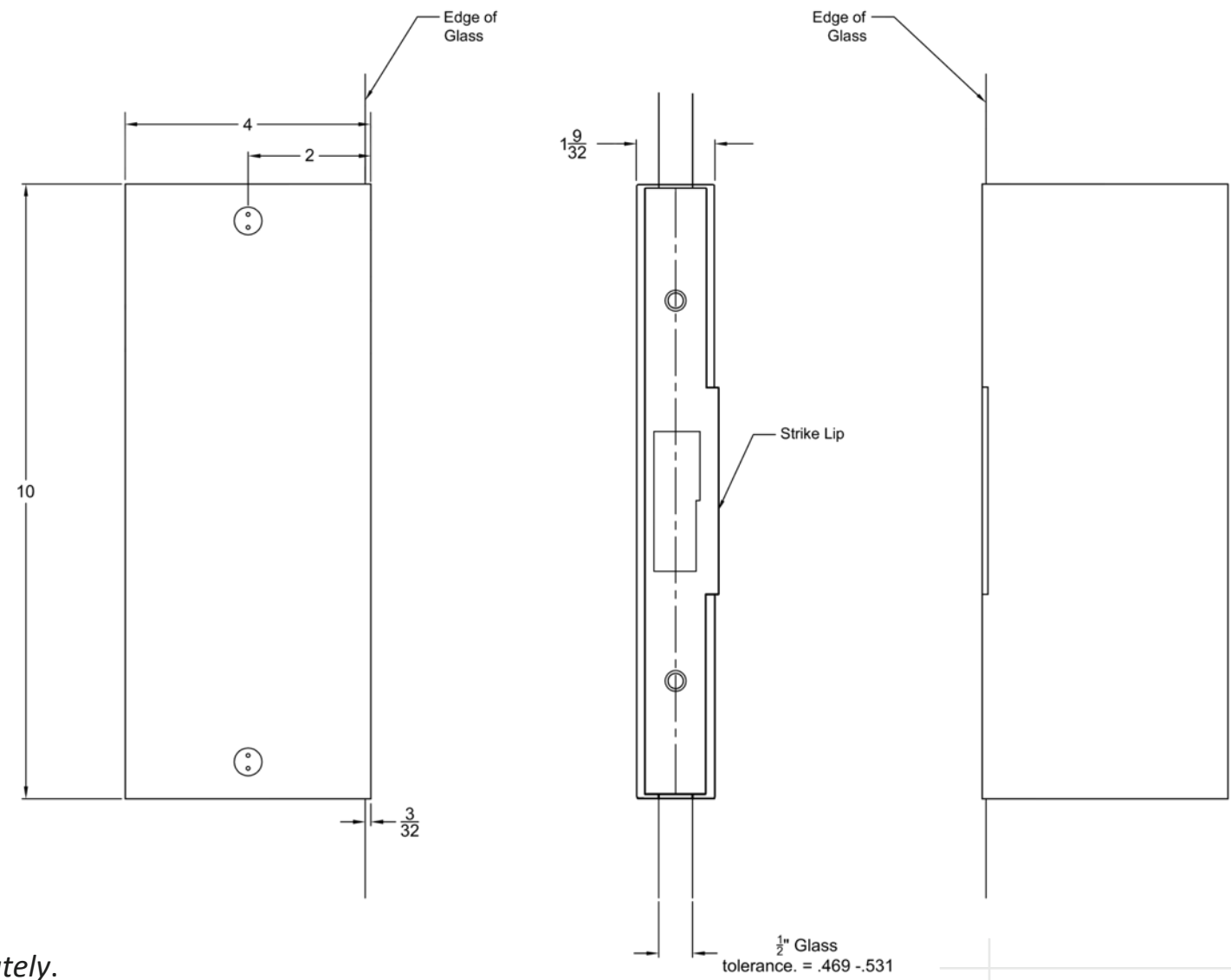

G87-GPS Glass Patch Strike specified and sold separately.

G87-GPS GLASS PATCH STRIKE

G87 Glass Prep Template

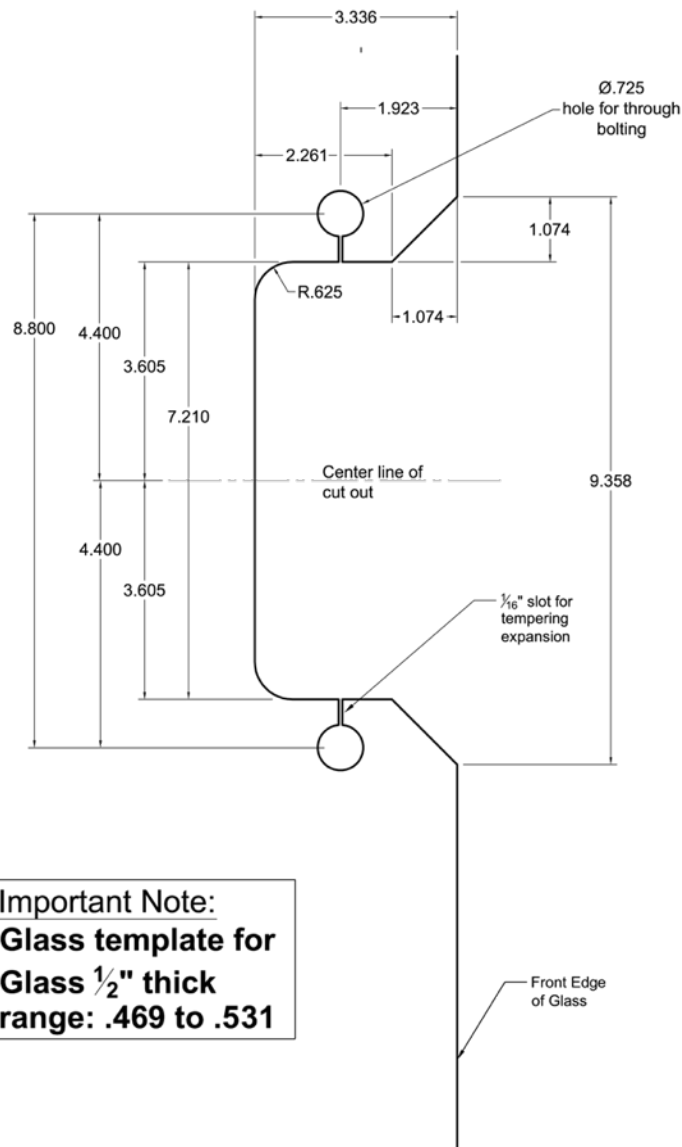

Important Note:
Glass template for
Glass $\frac{1}{2}$ " thick
range: .469 to .531

G87-GPS Glass Prep Template

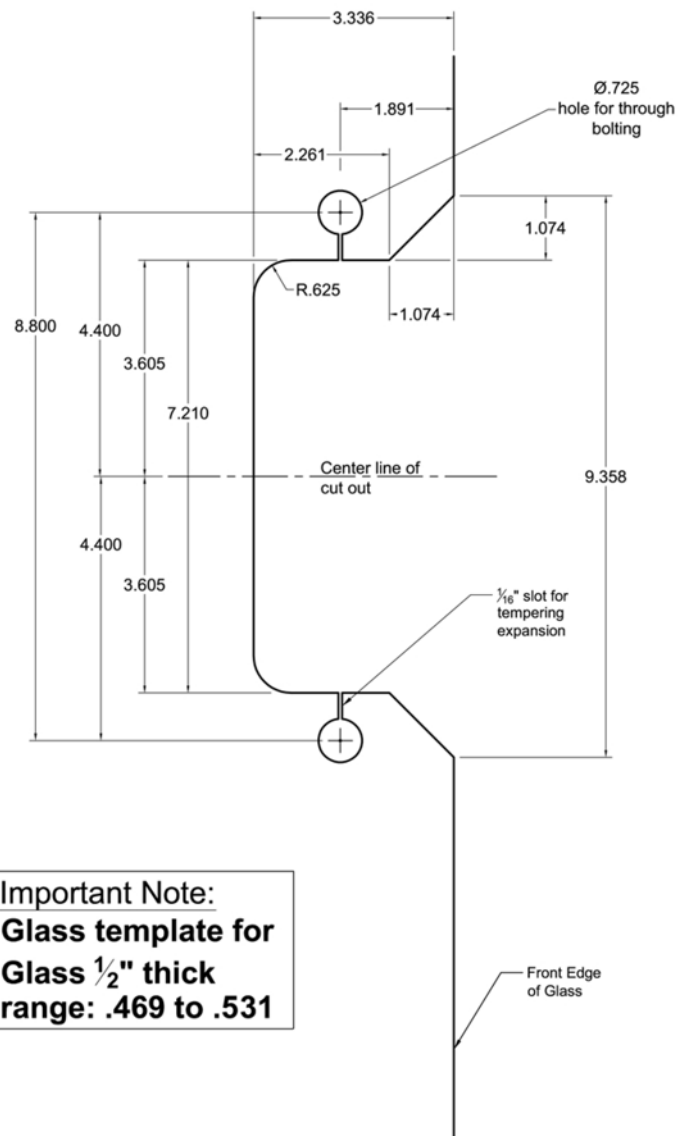

**G87-GPS STRIKE GLASS PREP
 TEMPLATE**
(specified and sold separately)

Accurate Lever Trim

18L LEVER

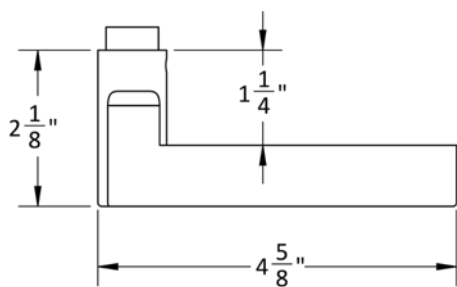

19L LEVER

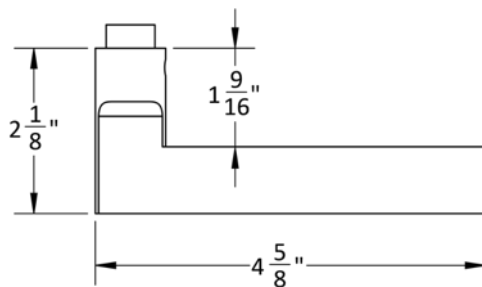

20L LEVER

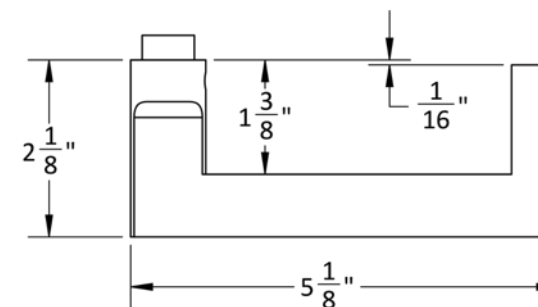
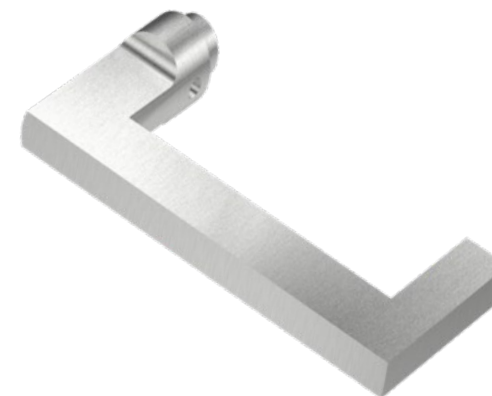

Accurate Lever Trim

21L LEVER

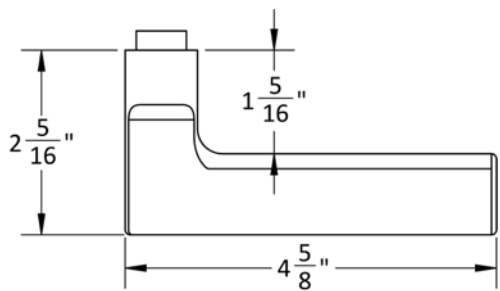

29L LEVER

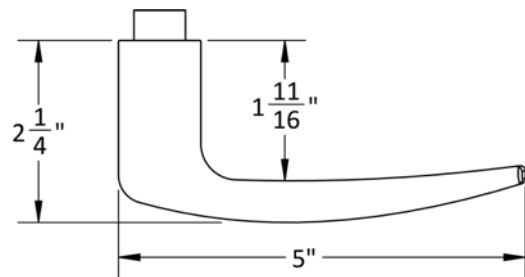

39L LEVER

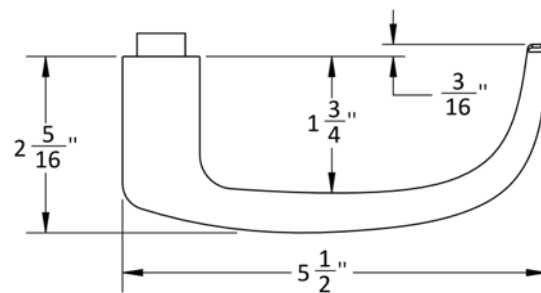

72L LEVER
Furnished Standard

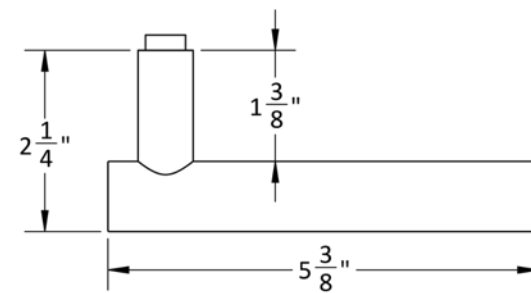

HOW TO SPECIFY

HANDING

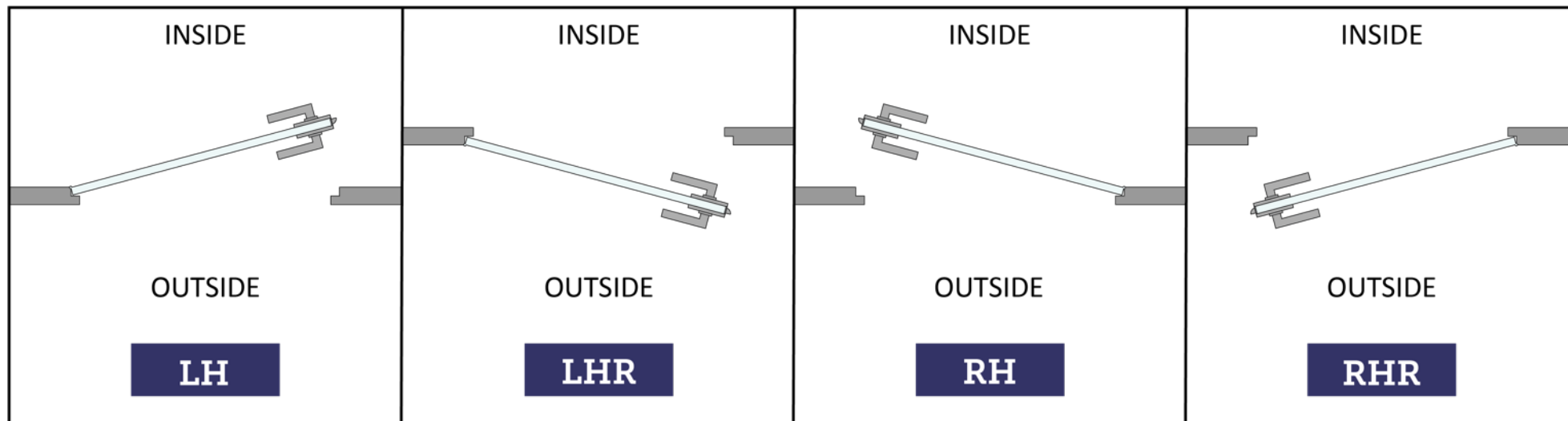

FINISHES

US28, ESN, US19

Other finishes available, please [contact us](#) for assistance.

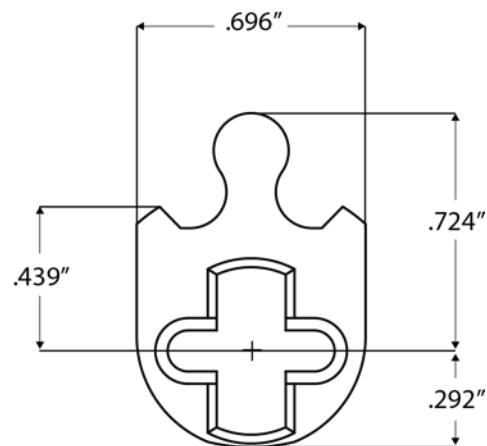

CYLINDERS & KEYING

G87 Series accepts any standard American mortise cylinder. For details on required cams and compatibility with other manufacturers' cylinders, please visit: [Accurate Support](#).

HOW TO SPECIFY

FUNCTION.BACKSET.TRIM.FINISH.HAND.DOORTHICKNESS.STRIKE

Functions

See available functions (pg. 4-6)

Backset

Standard 2" Backset

Trim

Accurate Lever
Trim Included
(pg. 11-12)

Finishes

See available
finishes (pg.13)

Door Thickness

Standard ½" glass door

G87-GPS*

G87-GPS Glass Patch Strike specify for frameless and glass wall applications.

SD Strike

Available for framed applications. No added cost.

**Strike Patches are specified and sold separately.*

EXAMPLES

G87 Dormitory | Centered | Glass Wall

E.g. G8724.2.72L.ESN.RH.1/2.G87-GPS

G87 Entrance or Office | Centered | Aluminum Frame (4-7/8"Strike)

E.g. G8756.2.18L.US19.LH.1/2.SD

G87 Privacy | Centered | No Strike

E.g. G8739.2.21L.US28.RH.1/2

NOTES

FURNISHED STANDARD WITH ANTI-FRICTION LATCH BOLT AS OF AUGUST 1, 2021 (solid latch bolt available, special order).

- G87 Series can be set up for levers by other manufacturers upon request.
- Access control applications available.
- Glass Patch Strikes (G87-GPS) sold and specified separately.

**ACCURATE LOCK & HARDWARE
MANUFACTURERS OF LOCKS AND
CUSTOM ARCHITECTURAL HARDWARE**

1 Annie Place | Stamford, CT 06902

P: 203.348.8865

F: 203.348.5234

E: sales@accuratelockandhardware.com

www.accuratelockandhardware.com



**AMERICAN CRAFTED
— SINCE 1972 —**