



# ACCURATE LOCK & HARDWARE

AMERICAN CRAFTED SINCE 1972

---

## Rabbeted Kits

STANDARD + TRADITIONAL STYLES FOR RABBETED DOOR JAMBS

## STANDARD RABBETED KIT

Shown with Accurate's 9100 Series lock, the **Standard Rabbeted Kit** is designed for door openings that feature a recess or groove cut into the wood, eliminating any gaps when doors are closed providing maximum privacy.

Shown with Thom Filicia for Accurate  
Henderson Knob and Rectangle  
Escutcheon

# RABBETED DOORS

Rabbeted kits were traditionally used before weather stripping became popular on exterior doors. Now they are commonly used to create seamless openings on interior pairs of doors. Each door is cut with a recess (half of the edge) so that high edge of the door meets the low edge of the other door creating a seamless closure that enhances privacy and eliminates gaps.

## STANDARD RABBETED KIT OPEN DOORS

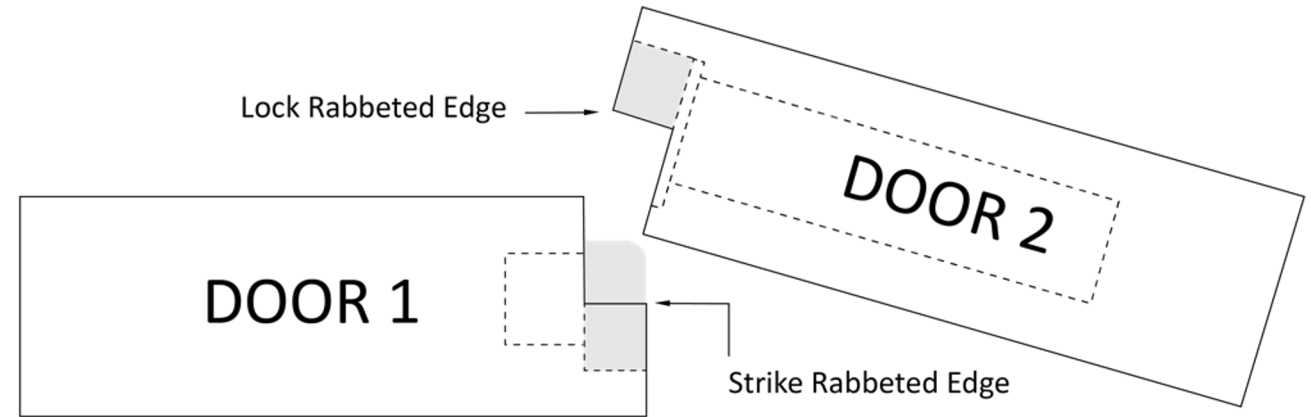

## STANDARD RABBETED KIT CLOSED DOORS

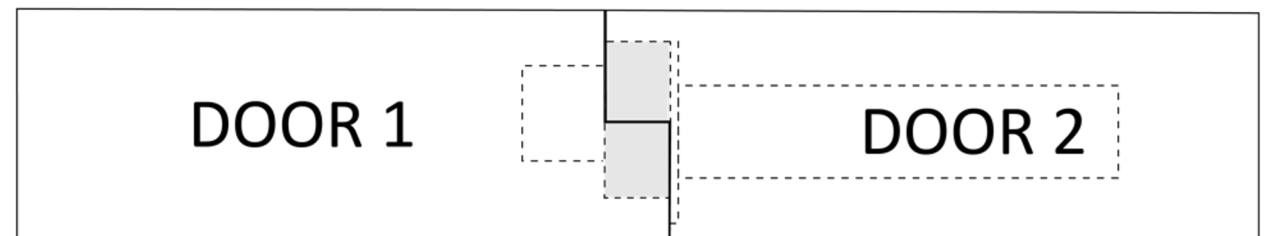

# STANDARD RABBETED KIT

9000 | 9100 SERIES



The above rabbeted kit works with most 9100 functions.  
Other rabbeted kits are available for functions with anti-pick bolts.

# STANDARD RABBETED KIT EXPLODED VIEW

## 9000 | 9100 SERIES

### LOCK SIDE

### STRIKE SIDE



# STANDARD RABBETED KIT

## FOR 8700 | 8800 SERIES

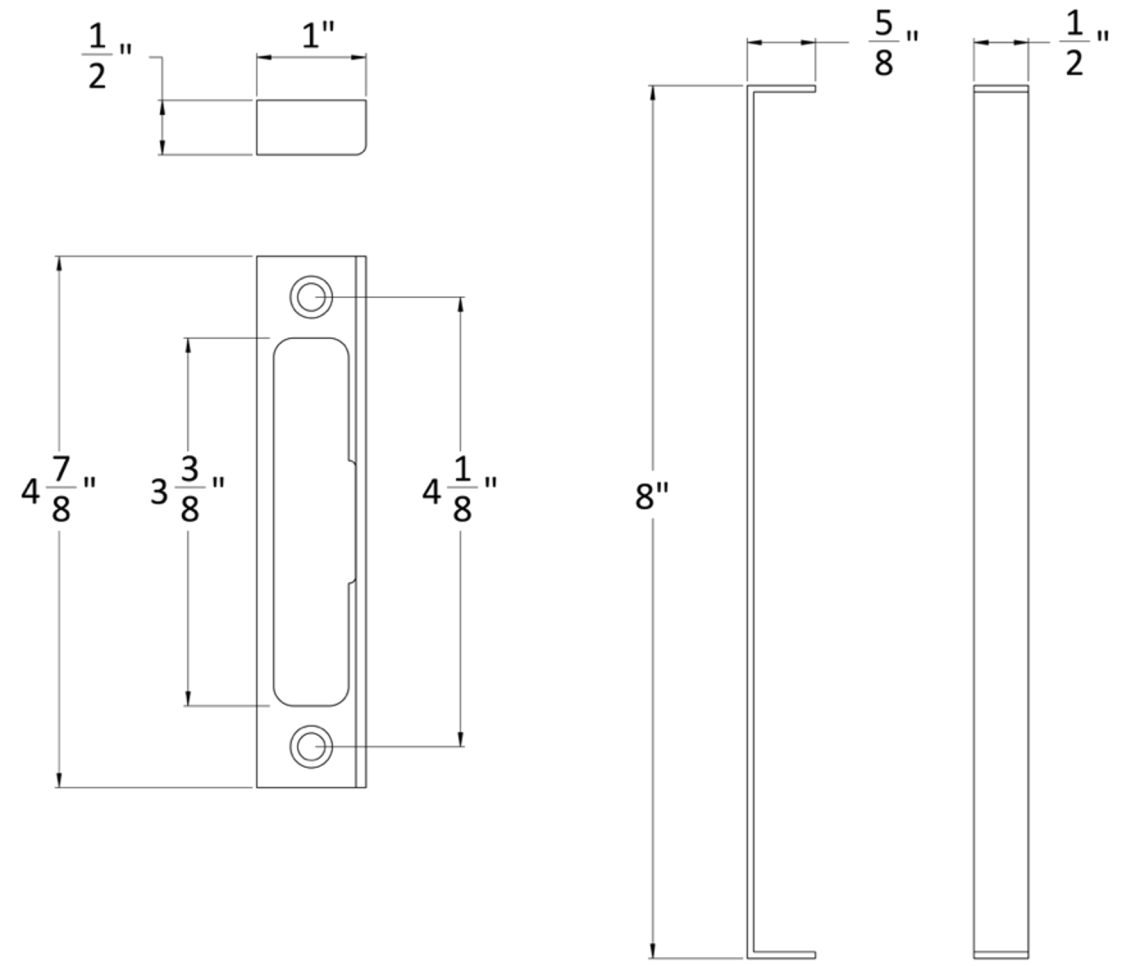

The above rabbeted kit works with most 8800 functions.  
 Other rabbeted kits are available for functions with anti-pick bolts.

# STANDARD RABBETED KIT EXPLODED VIEW

## FOR 8700 | 8800 SERIES

LOCK SIDE

STRIKE SIDE



## TRADITIONAL RABBETED KIT

Shown with Accurate's 9100 Series lock, the **Traditional Rabbeted Kit** is a more luxurious, upgraded design to result in an elegant, crisp and seamless closure designed for interior door openings that feature a recess or groove cut into the wood.

Shown with Thom Filicia for Accurate Henderson Knob and Rectangle Escutcheon



# RABBETED DOORS

The Traditional Rabbeted Kit is an upgraded design and comes standard with slotted screws.

Rabbeted kits were traditionally used before weather stripping became popular on exterior doors. Now they are commonly used to create seamless openings on interior pairs of doors. Each door is cut with a recess (half of the edge) so that high edge of the door meets the low edge of the other door creating a seamless closure that enhances privacy and eliminates gaps.

## TRADITIONAL RABBETED KIT OPEN DOORS

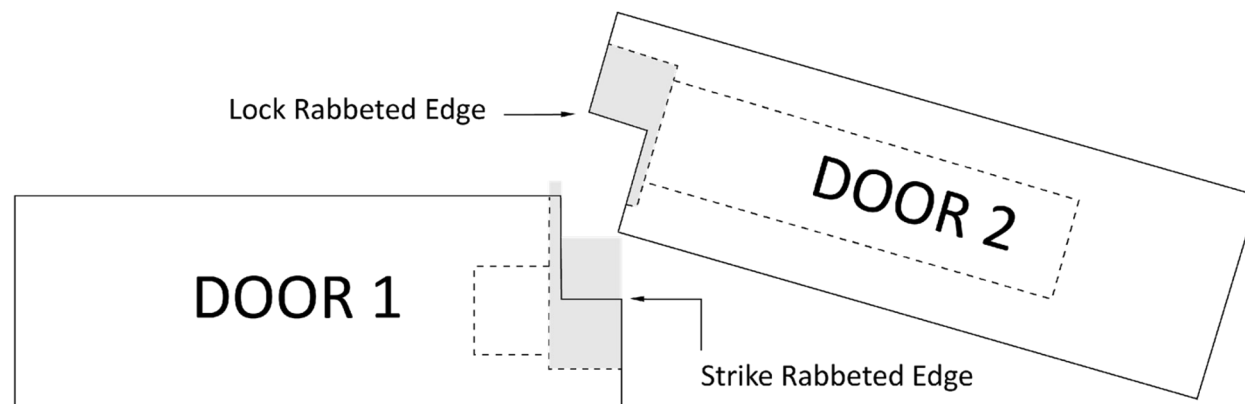

## TRADITIONAL RABBETED KIT CLOSED DOORS

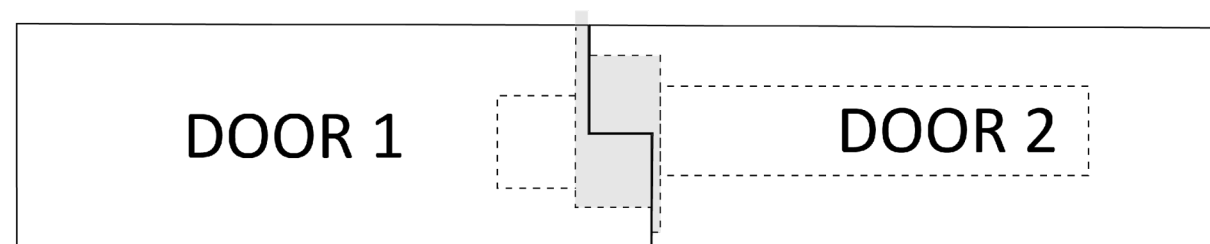

# TRADITIONAL RABBETED KIT

9000 | 9100 SERIES

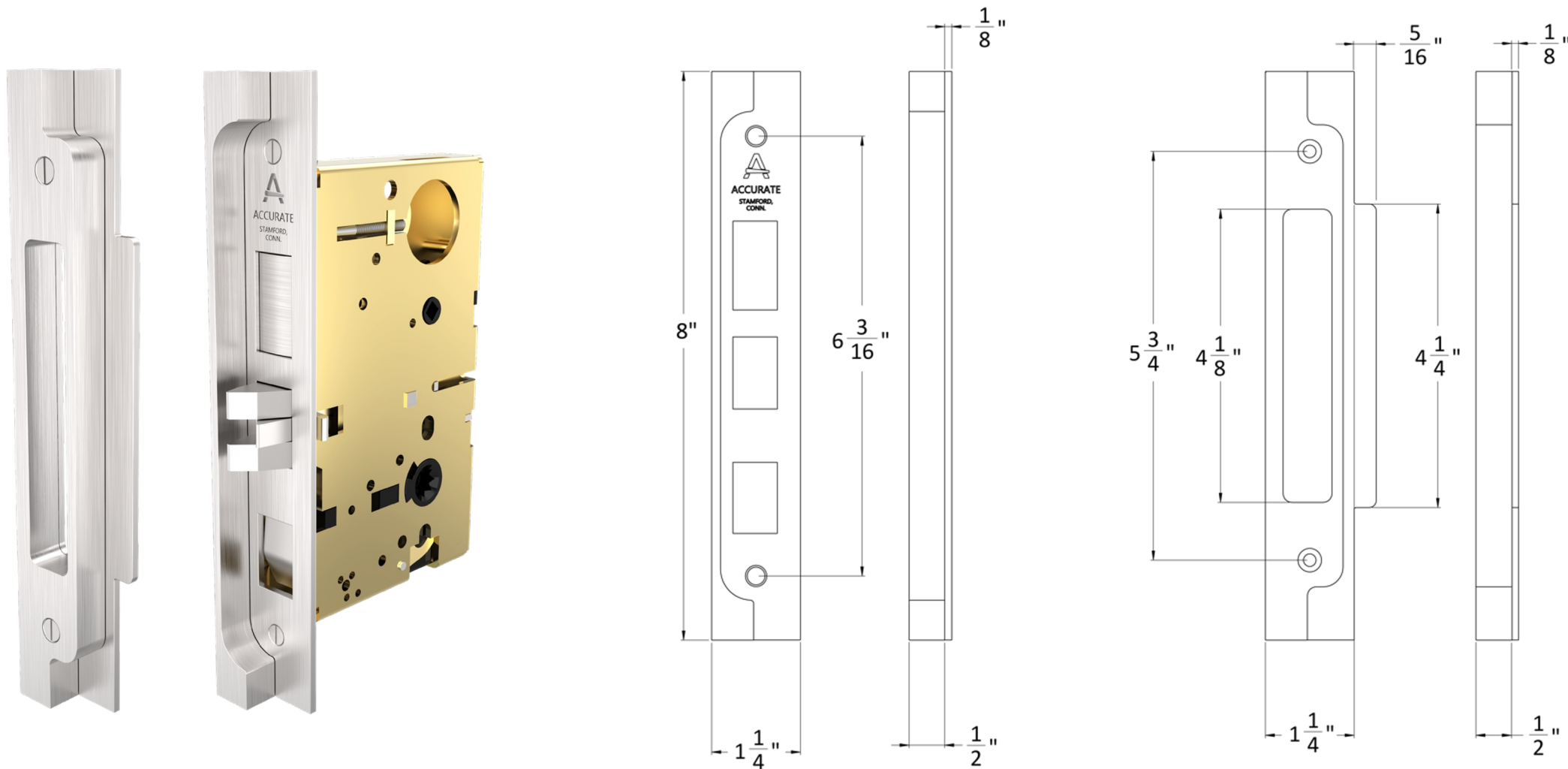

The above rabbeted kit works with most 9100 functions.  
Other rabbeted kits are available for functions with anti-pick bolts.

# TRADITIONAL RABBETED KIT EXPLODED VIEW

## 9000 | 9100 SERIES

LOCK SIDE

STRIKE SIDE



# TRADITIONAL RABBETED KIT

8700 | 8800 SERIES

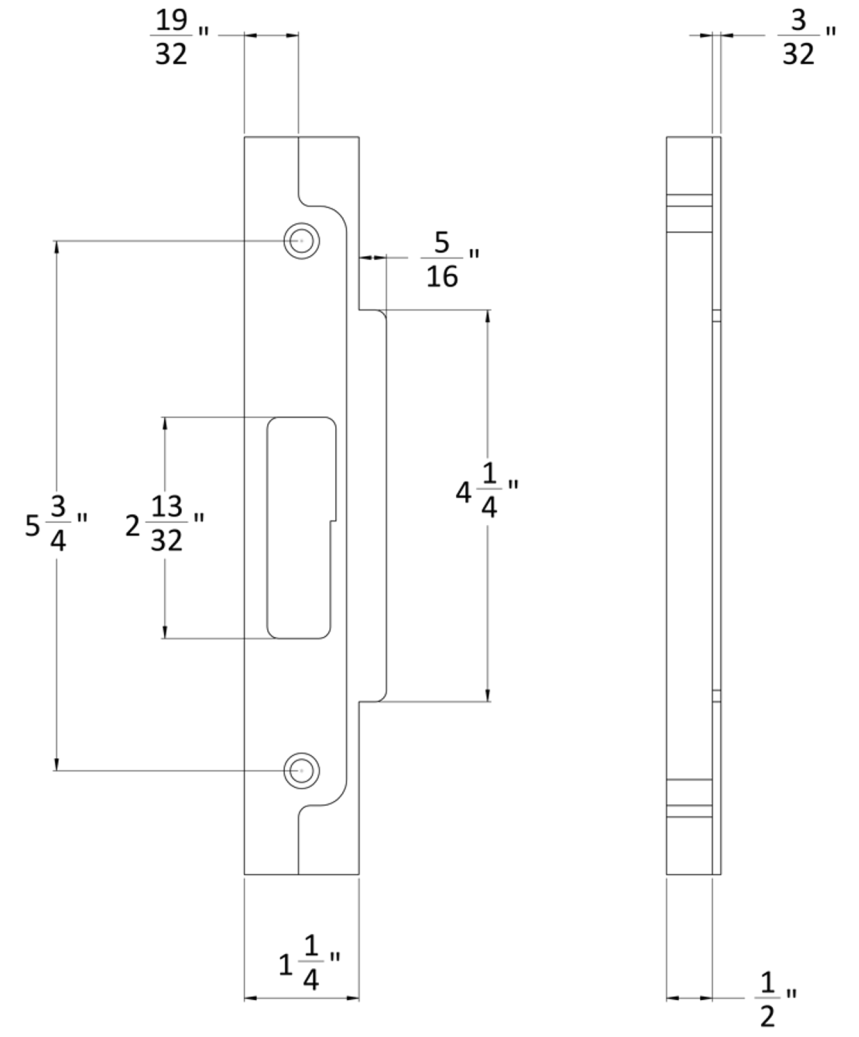
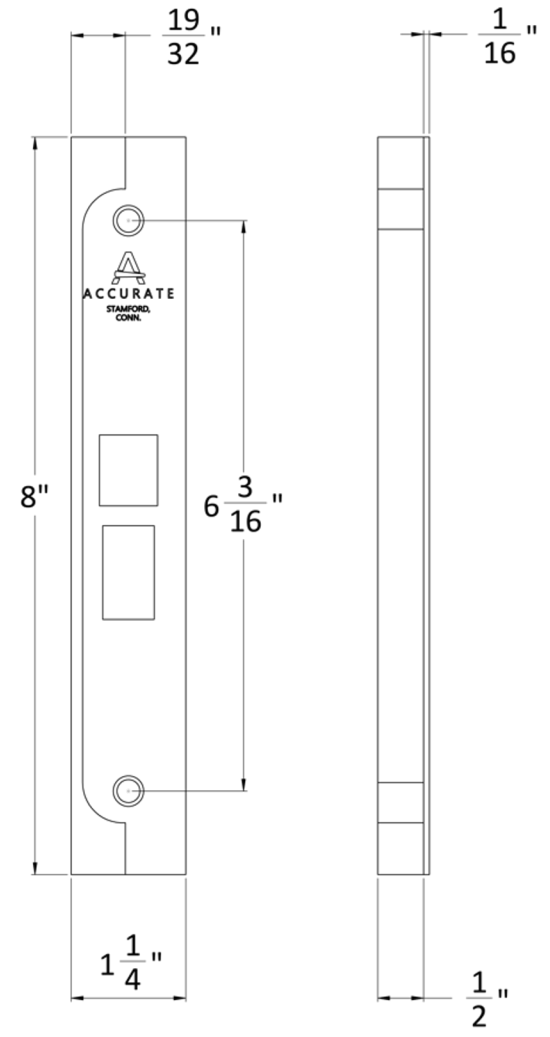

The above rabbeted kit works with most 8800 functions.  
Other rabbeted kits are available for functions with anti-pick bolts.

# TRADITIONAL RABBETED KIT EXPLODED VIEW

8700 | 8800 SERIES

LOCK SIDE

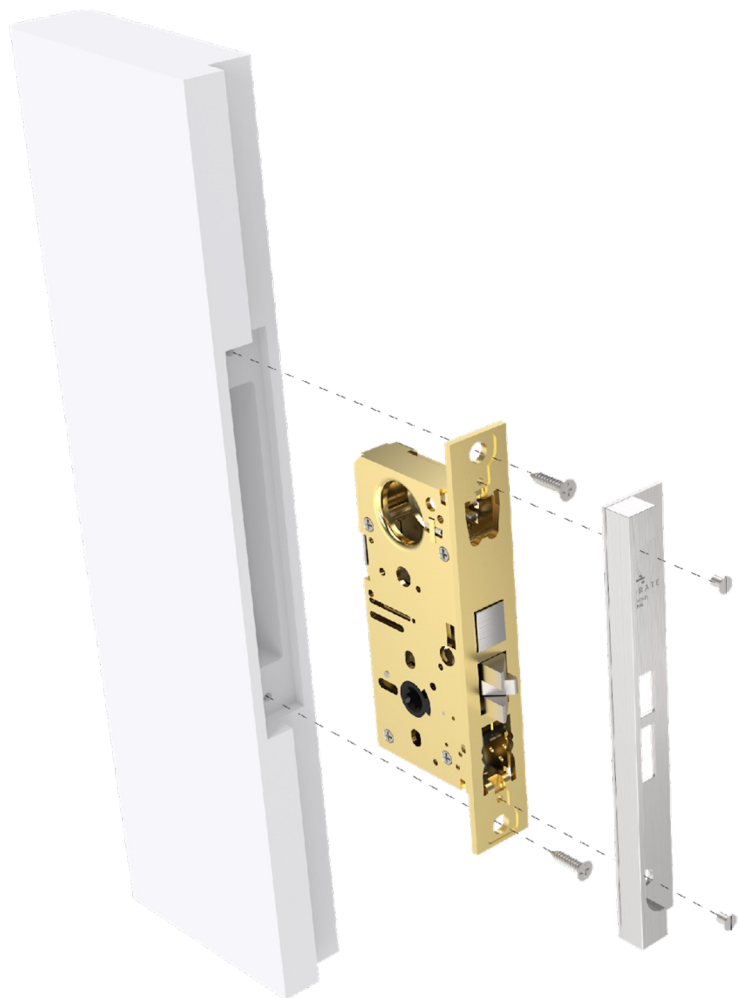

STRIKE SIDE



# TRADITIONAL RABBETED KIT

## 9500 SERIES

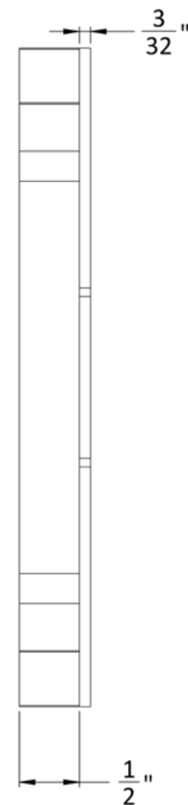
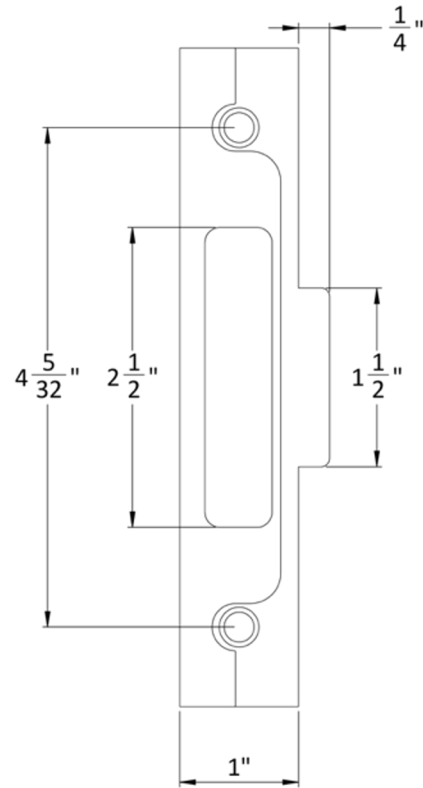
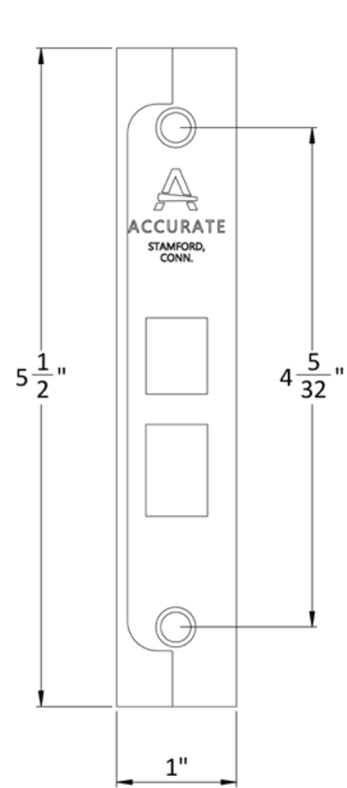

# TRADITIONAL RABBETED KIT EXPLODED VIEW

## 9500 SERIES

LOCK SIDE



STRIKE SIDE



# TRADITIONAL RABBETED KIT

## 9800 SERIES

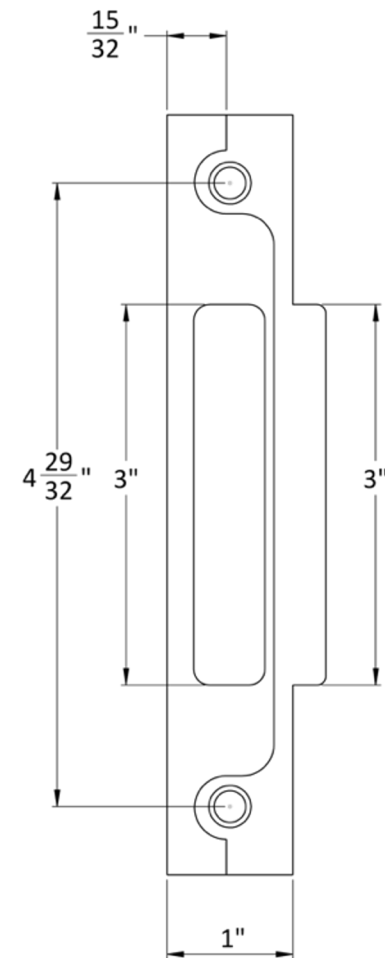
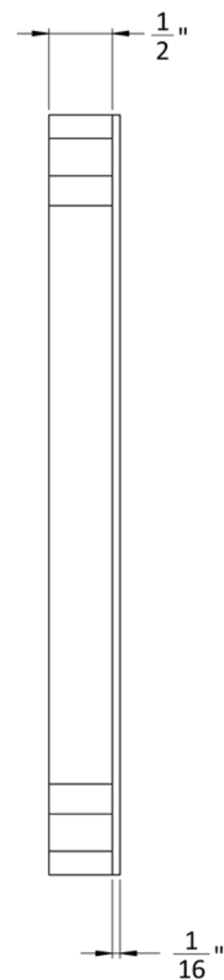
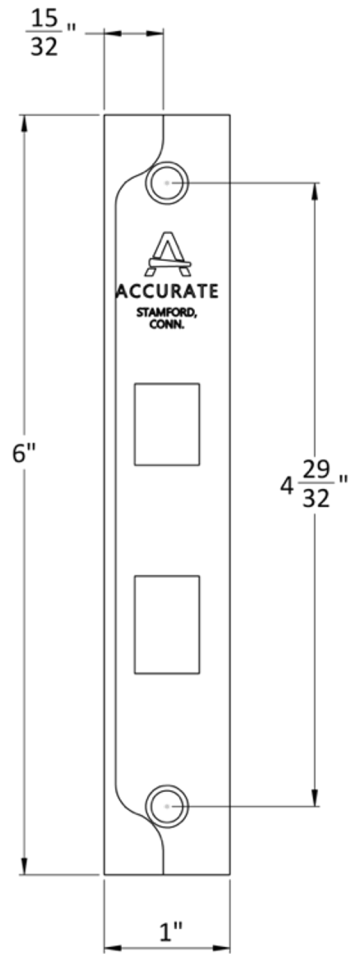



# TRADITIONAL RABBETED KIT EXPLODED VIEW

## 9800 SERIES

LOCK SIDE

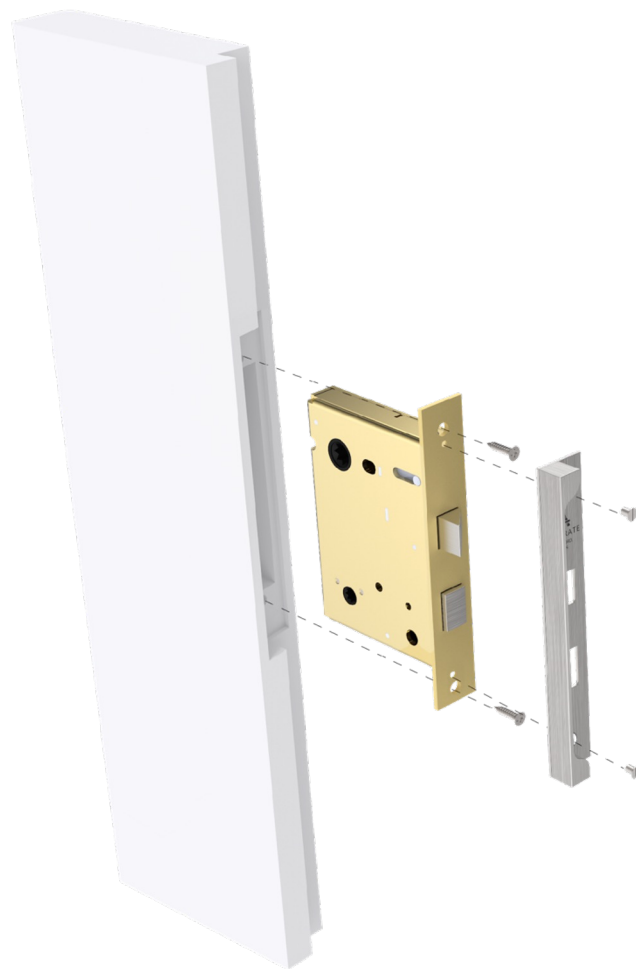

STRIKE SIDE



# HOW TO SPECIFY

## HANDING

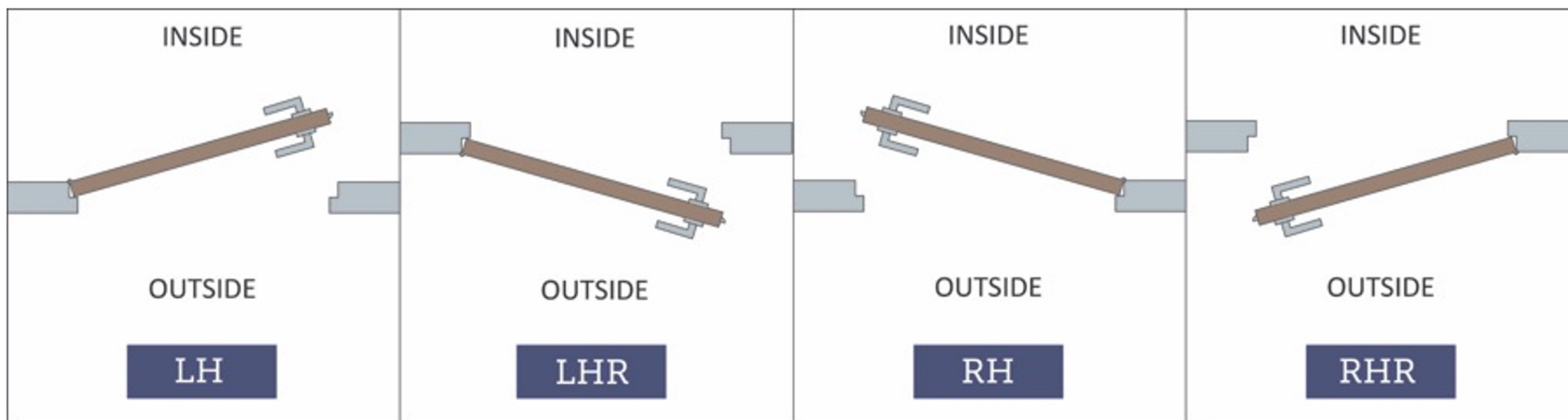

## FINISHES

**GROUP 1:** US4, US4NL, US32D\*, US26D

**GROUP 2:** US3, US3NL, US26, US32\*, US9\*, US10\*, US10B, US14, US15, US19

**GROUP 3:** BN, BB, TN, TB, DURO, ESN, US15A, US5

Applicable finishes come standard with Cerakote Premium Protective Coating. Available in gloss or matte.

*\* Trim options (including Accurate Levers) may not be available in US32D, US32, US9, or US10 finish. Please call for assistance.*

To view example of finishes visit: [Accurate Finishes](#).

## CYLINDERS & KEYING

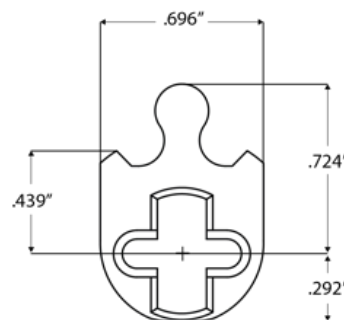

9000/9100 and 8700/8800 Series locks accept any standard American mortise cylinder. For details on required cams and compatibility with other manufacturers' cylinders, please visit: [Accurate Support](#).

# HOW TO SPECIFY

RAB.LOCK.BACKSET.TRIM.FINISH.HAND.DOORTHICKNESS

**RABBETED STYLE**  
Standard or Traditional

**LOCK**  
9000/9100  
8700/8800  
9500/9800

**BACKSET**  
Based on lock

**TRIM**  
Accurate or Other  
Manufacturers' Trim

**FINISHES**  
See available finishes (pg.18)

## EXAMPLES

**Standard Rabbeted Kit | 9100 | Accurate Trim**  
E.g.: STD.RAB.9134.212.19L/1R.US4.RH.134

**Standard Rabbeted Kit | 8800 | Accurate Trim**  
E.g.: STD.RAB.8845.234.21L/1E.US4.RH.134

**Traditional Rabbeted Kit | 9500 | Accurate Trim**  
E.g.: TRAD.RAB.9539.234.18L/2R.US4.LH.134

**Traditional Rabbeted Kit | 9800 | Other Manufacturers' Trim**  
E.g.: TRAD.RAB.9825.234.LxL.8mm.US4.LH.134

## NOTES

- Typical rabbeted prep is 1/2" from high side to low side of door, with cut centered on the door. For other preps, please call for assistance.
- 9500/9800 Rabbeted Kits available as Traditional Only

**ACCURATE LOCK & HARDWARE  
MANUFACTURERS OF LOCKS AND  
CUSTOM ARCHITECTURAL HARDWARE**

1 Annie Place | Stamford, CT 06902

**P:** 203.348.8865

**F:** 203.348.5234

**E:** [sales@accuratelockandhardware.com](mailto:sales@accuratelockandhardware.com)

**[www.accuratelockandhardware.com](http://www.accuratelockandhardware.com)**



**AMERICAN CRAFTED  
— SINCE 1972 —**