

# Standard 2001ADA-1 Template

For use with:  
 2001.212 - Sliding door lock  
 2001SD - 2001 Strike  
 2001DB - 2001 dust box  
 7200P - Back to back pulls  
 Cylinder and collar by others

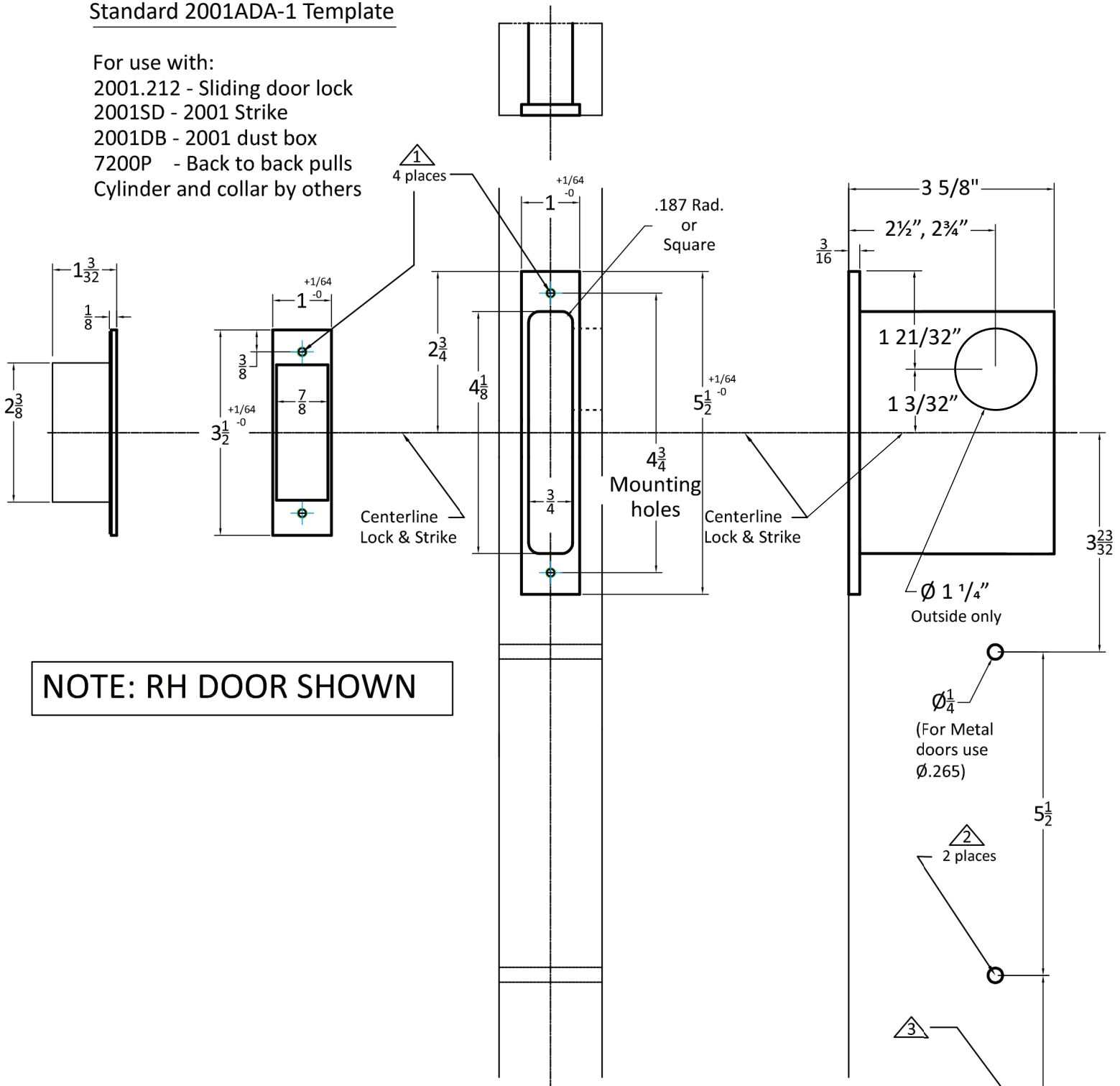

**NOTE: RH DOOR SHOWN**

**Notes:**

- ▲ Prep for #8 wood or 8-32 machine screws
- ▲ The holes for the 7200P back to back pulls are meant to be very tight, the installer can tap the cone head thru-bolts in place with a rubber mallet for wood doors.
- ▲ The Bottom of the 7200P pull handle must be installed 34" (35 1/8" to the center line of the bottom post) from the finished floor. This will give 47" (the max is 48") from the finished floor to top of 7200ADA handle, thus meeting Code 404.2.7. It is the installers responsibility to make sure that the most up to date state and federal codes are followed.

**Additional Notes:**

- a) **Responsibility:** Door and frame manufacturers are responsible for providing adequate construction or re-inforcement for proper installation of hardware shown.
- b) For double doors, please see template #T-ALH.2001ADAEP(2)
- c) See catalog / spec sheets for additional lock details



2001.ADA-1 2 1/2" - Backset Template

T-ALH.2001ADAP-1