



# ACCURATE LOCK & HARDWARE

AMERICAN CRAFTED SINCE 1972

---

## Interior Mortise Locks

Quality and versatility to complement the most discerning design vision

# 3 New Reasons To Use Interior Mortise Locks

## THAT COMPLEMENT THE MOST DISCERNING DESIGN VISION

1. For use on narrow stile doors – now available with 2” backset.
2. Achieve a quiet and seamless solution when ordered with the magnetic latch
3. Hub Adjust feature – the new standard that keeps levers perfectly level regardless of their design



**9500/9800 SERIES WITH MAGNETIC LATCH BOLT**

# 9500/9800 Series Interior Mortise Locks

- For interior doors
- Passage, privacy and bit key functions
- European style installation (Lever High) standard, available to order as "UPSIDE DOWN" (Lever Low)
- 2", 2 ½" or 2 ¾" backset (for door stiles starting at 3"\*)
- Custom backsets, marine grade and/or non-ferrous options available (for most applications)
- Magnetic latch bolt option paired with a non-lipped strike for quiet operation and minimalistic design
- 9500 series features a 2 ¼" vertical spacing while on the 9800 series the vertical spacing is 2<sup>7</sup>/<sub>8</sub>" (to allow the use of larger trim designs)
- Rabbeted kits also available

\* With a 2" backset, lock body measures 2<sup>7</sup>/<sub>8</sub>" overall



**9539ML PRIVACY LOCK WITH MAGNETIC LATCH BOLT**

# 9500 Series: Technical Details

For use with Accurate's levers or knobs or prepared for use with other manufacturers' trim (for compatibility please verify vertical spacing as well as thru bolting locations or call for assistance)

Furnished standard with Hub Adjust Feature which keeps levers perfectly level and can easily be adjusted onsite.

(Not available on 2" backset locks.)

**CASE:** Heavy Gauge Steel ( $\frac{3}{4}$ " thick)

**ARMOR FRONT:** Adjustable bevel. Made from brass, bronze or stainless steel and finished as required

**LATCH BOLT:**  $\frac{7}{16}$ " throw. Brass or stainless steel for standard locks or magnetic stainless steel for ML magnetic latch locks

**DEADBOLT:** Brass or stainless steel.  $\frac{1}{2}$ " throw

**HUBS:** Available in different sizes to be compatible with various trims

**THUMB TURN HUB:**  $\frac{3}{16}$ " (5mm) on the diamond and on the square  
Specialty 5mm or 6mm square hub available as a special order

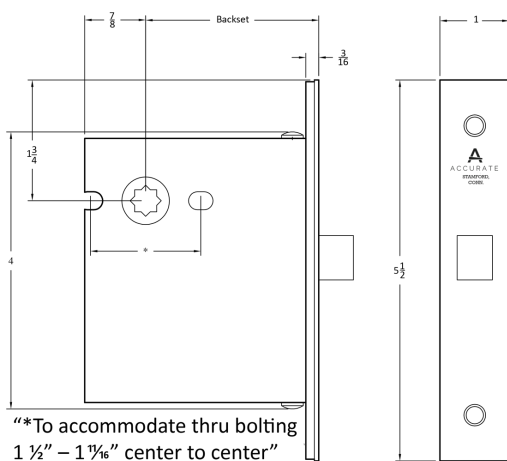

9525

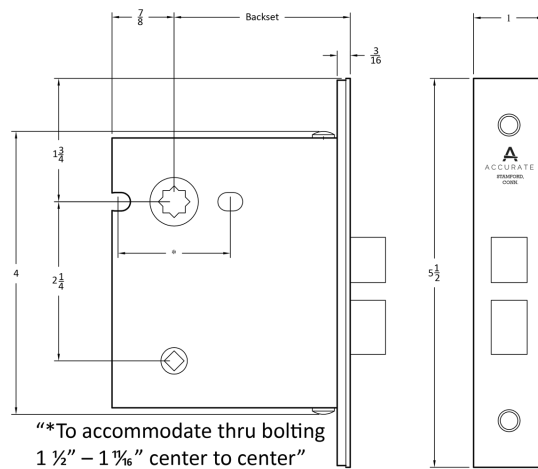

9539

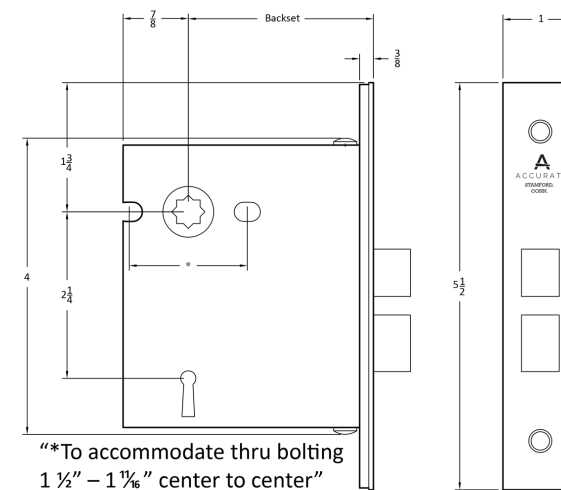

9524

# 9500 Series: Functions

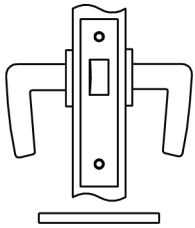

## **9525** **INTERIOR PASSAGE & CLOSET LATCH**

Latch bolt by lever either side.

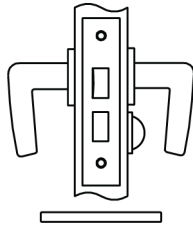

## **9539** **INTERIOR PRIVACY** **BEDROOM OR BATHROOM LOCK**

Latch bolt by knob or lever either side.

Deadbolt by turn piece inside and optional emergency key outside.

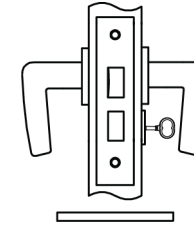

## **9524** **INTERIOR PRIVACY BIT KEY LOCK**

Latch bolt by knob or lever either side.

Deadbolt by bit key inside and outside.

One solid brass bit key furnished with each lock – extra keys available to order.  
(P/N 09-BK)

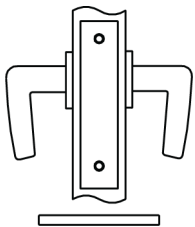

## **9500ADL** **ACTIVE DUMMY LOCK**

Active handles inside and outside.

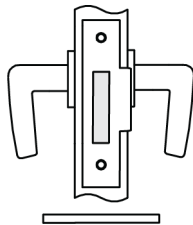

## **9500ADLS** **ACTIVE DUMMY LOCK** **PREPARED AS STRIKE**

Active handles inside and outside.

For use on “dummy door” (in double door applications where the active lock has a 9525 or 9539 lock, please specify.)

# 9500ML Series Lock with Magnetic Latch



**Seamless Doorway**



**Non-lipped Strike**

- Seamless, non-lipped strike is invisible when door is closed
- Non-handed for simple installation Quiet Operation: a powerful rare-earth magnet projects the latch bolt to secure the door.

## 9500ML FUNCTIONS

### 9525ML

#### Interior Passage and Closet Latch

Latch bolt by lever either side.

### 9539ML

#### Interior Privacy Bedroom or Bathroom Lock

Latch bolt by knob or lever either side.

Deadbolt by turn piece inside and optional emergency key outside.

### 9524ML

#### Interior Privacy Bit Key Lock

Latch bolt by knob or lever either side.

Deadbolt by bit key inside and outside.

*One solid brass bit key furnished with each lock—extra keys available to order.*

*(P/N 09-BK).*

# 9800 Series: Technical Details

For use with Accurate's levers or knobs or prepared for use with other manufacturers' trim (for compatibility please verify vertical spacing as well as thru bolting locations or call for assistance)

Furnished standard with Hub Adjust Feature which keeps levers perfectly level and can easily be adjusted onsite.

(Not available on 2" backset locks.)

**CASE:** Heavy Gauge Steel ( $\frac{3}{4}$ " thick)

**ARMOR FRONT:** Adjustable bevel. Made from Brass, bronze or stainless steel and finished as required

**LATCH BOLT:**  $\frac{7}{16}$ " throw. Brass or stainless steel for standard locks or magnetic stainless steel for ML magnetic latch locks

**DEADBOLT:** Brass or stainless steel.  $\frac{1}{2}$ " throw

**HUBS:** Available in different sizes to be compatible with various trims

**THUMB TURN HUB:**  $\frac{3}{16}$ " (5mm) on the diamond and on the square Specialty 5mm or 6mm square hub available as a special order

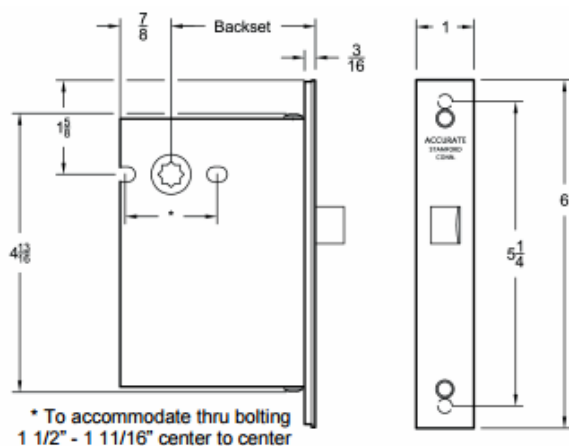

9825

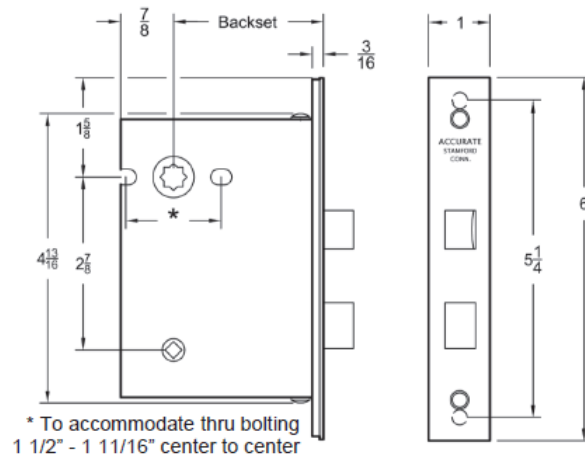

9839

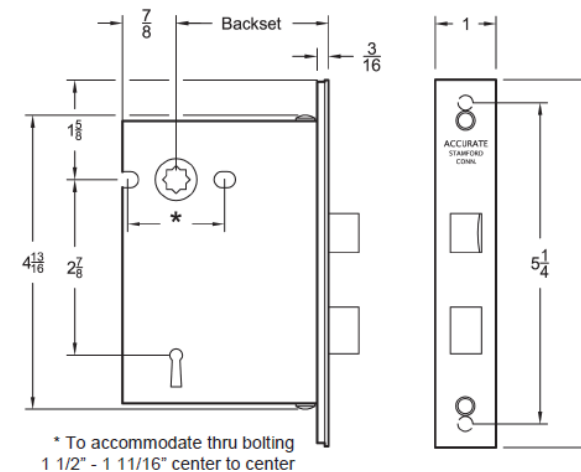

9824

# 9800 Series: Functions

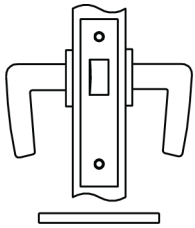

## **9825** **INTERIOR PASSAGE & CLOSET LATCH**

Latch bolt by lever either side.

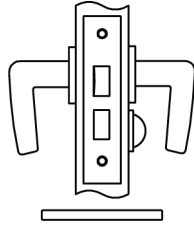

## **9839** **INTERIOR PRIVACY** **BEDROOM OR BATHROOM LOCK**

Latch bolt by knob or lever either side.

Deadbolt by turn piece inside and optional emergency key outside.

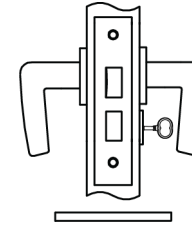

## **9824** **INTERIOR PRIVACY BIT KEY LOCK**

Latch bolt by knob or lever either side.

Deadbolt by bit key inside and outside.

One solid brass bit key furnished with each lock – extra keys available to order.  
(P/N 09-BK)

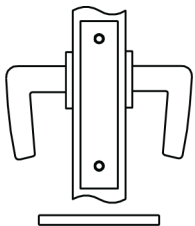

## **9800ADL** **ACTIVE DUMMY LOCK**

Active handles inside and outside.

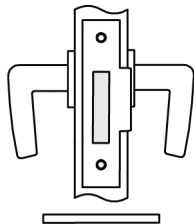

## **9800ADLS** **ACTIVE DUMMY LOCK** **PREPARED AS STRIKE**

Active handles inside and outside.

For use on “dummy door” (in double door applications where the active lock has a 9825 or 9839 lock, please specify.)



# 9800ML Series Lock with Magnetic Latch



**Seamless Doorway**

- Seamless, non-lipped strike is invisible when door is closed
- Non-handed for simple installation. Quiet Operation: a powerful rare-earth magnet projects the latch bolt to secure the door.



**Non-lipped Strike**

## 9800ML FUNCTIONS

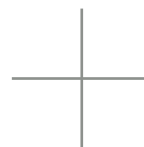

### **9825ML**

#### **Interior Passage and Closet Latch**

Latch bolt by lever either side.

### **9839ML**

#### **Interior Privacy Bedroom or Bathroom Lock**

Latch bolt by knob or lever either side.

Dead bolt by turn piece inside and optional emergency key outside.

### **9824ML**

#### **Interior Privacy Bit Key Lock**

Latch bolt by knob or lever either side.

Dead bolt by bit key inside and outside.

*One solid brass bit key furnished with each lock—extra keys available to order (P/N 09-BK).*

# Accurate Lever Trim

### 18L LEVER

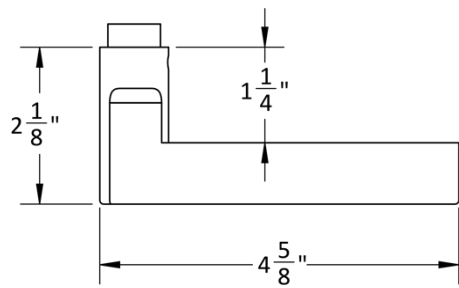

### 19L LEVER

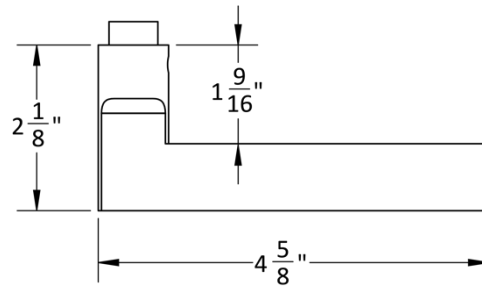

### 20L LEVER

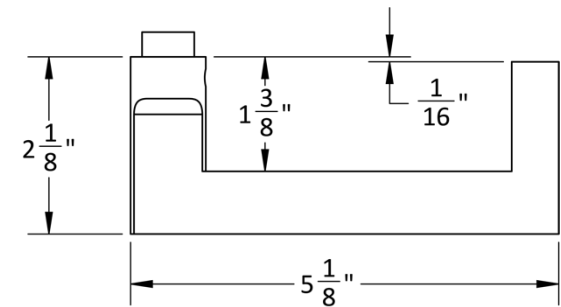
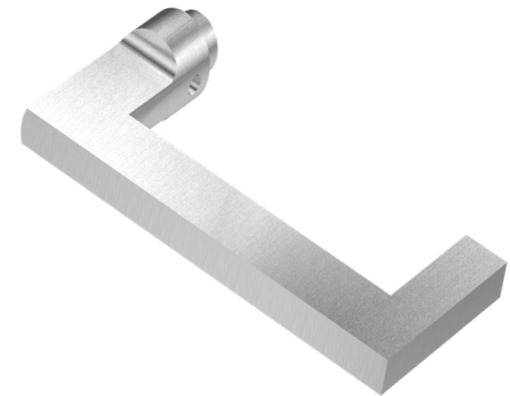

# Accurate Lever Trim

**21L LEVER**

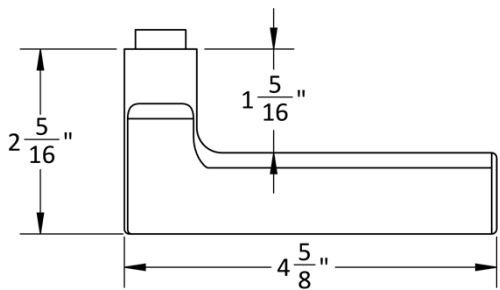

**29L LEVER**

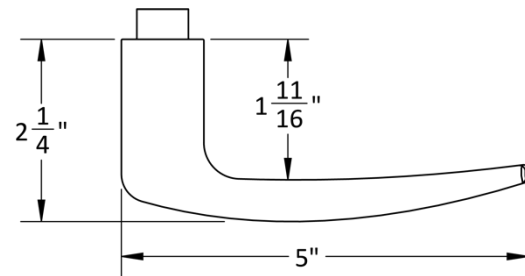

**39L LEVER**

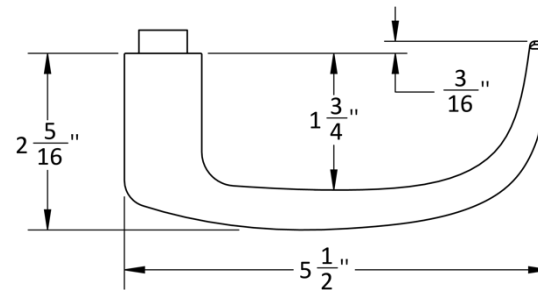

**72L LEVER**

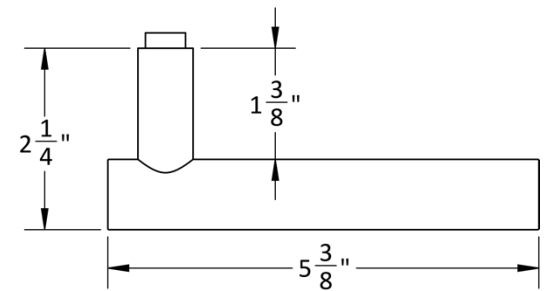

# Accurate Rose Options

### 1R ROSE

Front

Side

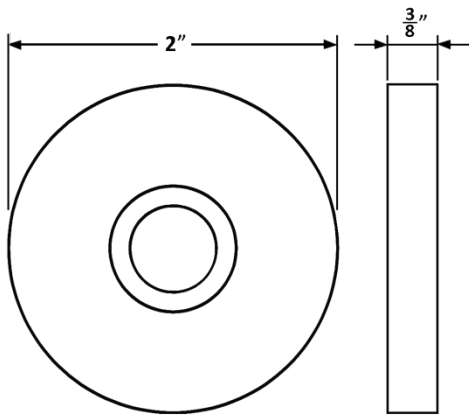

SILENTPAC™ LEVER DAMPENING DISC CAN BE SPECIFIED WITH THE 1R ROSE VISIT [SILENTPACSOLUTIONS.COM](http://SILENTPACSOLUTIONS.COM)

### 2R ROSE

Side

Inside

Outside

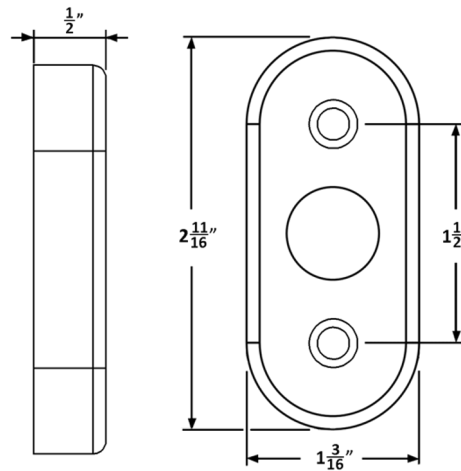

### 4R ROSE

Side

Inside

Outside

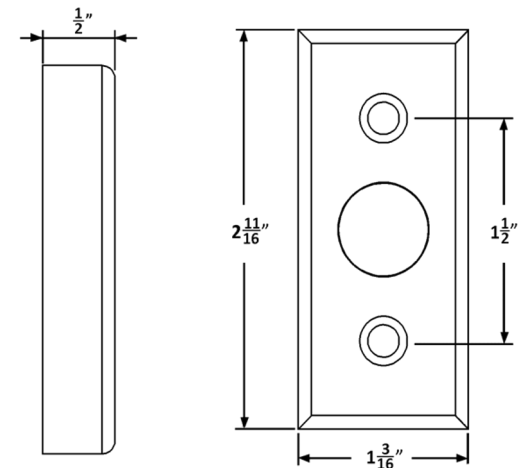

# HOW TO SPECIFY

## HANDING

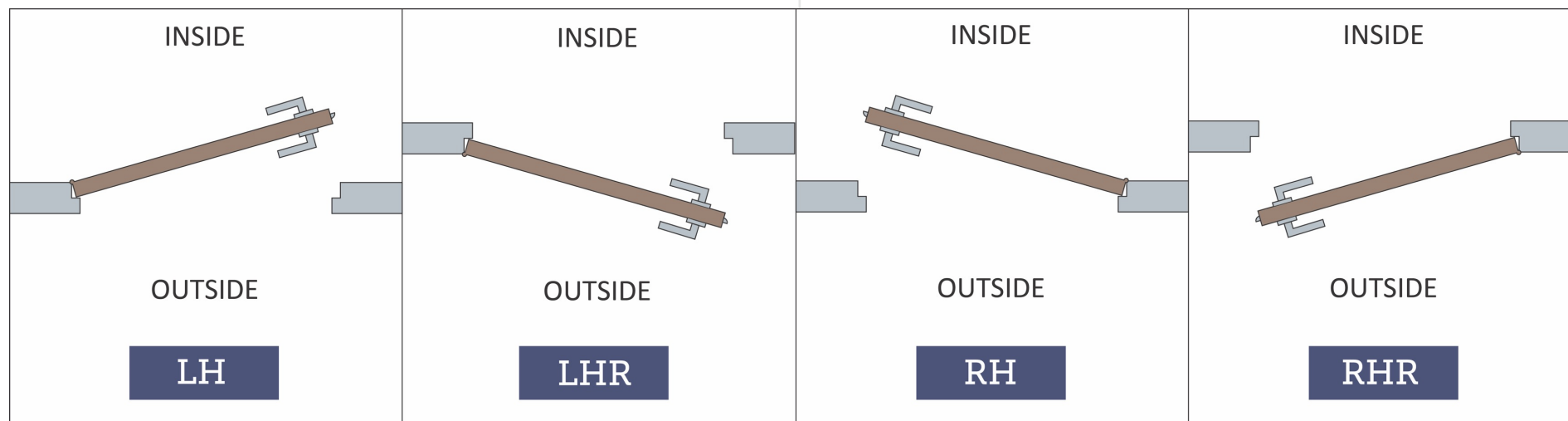

## FINISHES

**GROUP 1:** US4, US4NL, US32D, US26D

**GROUP 2:** US3, US3NL, US26, US32, US9, US10, US10B,  
US14, US15, US19

**GROUP 3:** BN, BB, TN, TB, DURO, ESN, US15A, US5

To view examples of finishes visit: [Accurate Finishes](#)

# HOW TO SPECIFY

**FUNCTION.BACKSET.TRIM.FINISH.HAND.DOORTHICKNESS**

## FUNCTIONS

See available functions  
(pg. 5-6, 8-9)

## BACKSET

2", 2-1/2" , 2-3/4"

## TRIM

- Accurate Lever Trim
- Other Manufacturers' Trim\*

Configurations:

- LxL, KxK

Hub Size:

- Specify hub size or architectural hardware brand lever/knob

## FINISHES

See available finishes  
(pg.12)

## Handing

No need to specify when  
ordering ML locks

## EXAMPLES

Accurate 9500 Interior Mortise | Other Manufacturers' Trim

E.g.: 9539.2.LxL.8mm.US3.RH.214

Accurate 9500 Magnetic Latch | Accurate Trim

E.g.: 9525ML.212.19L/1R.US26D.134

Accurate 9800 Interior Mortise | Other Manufacturers' Trim

E.g.: 9839.234.LxL.8mm.US3.RH.214

Accurate 9800 Magnetic Latch | Accurate Trim

E.g.: 9825ML.212.18L/1R.US26D.134

*Note: For compatibility please verify vertical spacing as well as through-bolting locations or call for assistance.*

# HUB ADJUST FEATURE

Standard feature on 9500/9800  
(Not available on 2" Backset)

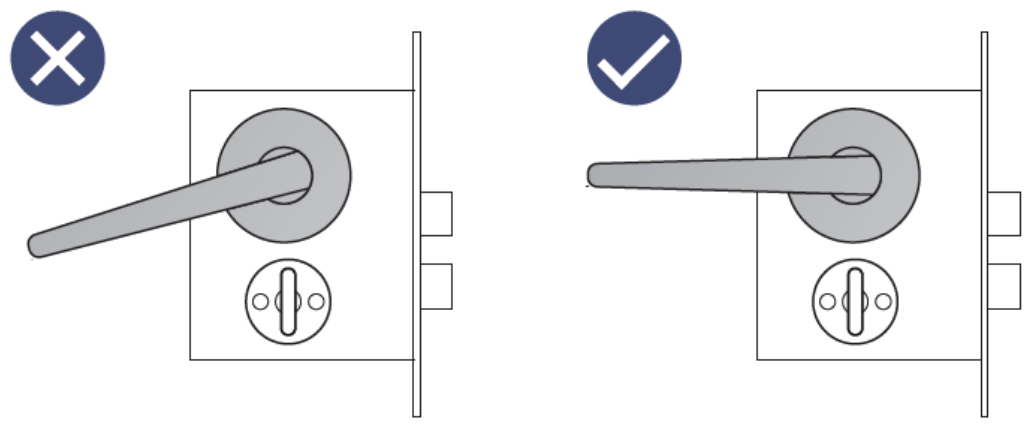

## How To:

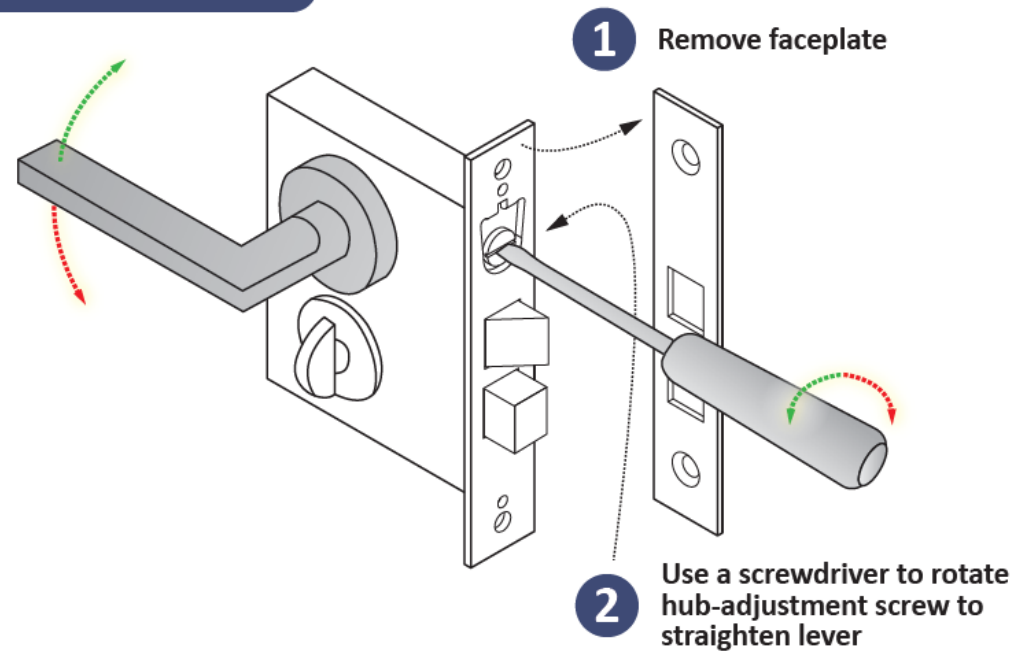

**ACCURATE LOCK & HARDWARE  
MANUFACTURERS OF LOCKS AND  
CUSTOM ARCHITECTURAL HARDWARE**

1 Annie Place | Stamford, CT 06902

**P:** 203.348.8865

**F:** 203.348.5234

**E:** sales@accuratelockandhardware.com

**[www.accuratelockandhardware.com](http://www.accuratelockandhardware.com)**



**AMERICAN CRAFTED  
— SINCE 1972 —**