



ACCURATE
LOCK & HARDWARE
AMERICAN CRAFTED SINCE 1972

GR86 SERIES

RABBETED GLASS PATCH MORTISE SETS FOR OFFSET GLASS APPLICATIONS



A SLEEK SPECIALTY GLASS SOLUTION

GR86 SERIES

This rabbeted glass patch kit is designed for offset on-glass applications with privacy gasketing. The GR86 is offered as a complete package including lock body, patch assembly and levers, compatible with US mortise cylinders.

GR8656 RABBETED GLASS PATCH WITH 18L LEVERS

GR86 Series

RABBETED GLASS PATCH HARDWARE SETS

- Maintain sleek, modern aesthetic where glass doors are prominent
- Compatible with various partition system configurations
- For inswing and outswing doors that utilize proprietary framing
- Standard set up is for a 1 1/2" backset lockset on 1/2" thick tempered glass
- Quick and simple door prep and installation



**GR8656 FUNCTION
SHOWN ON RH DOOR**

GR86 Rabbeted Glass Patch Dimensions

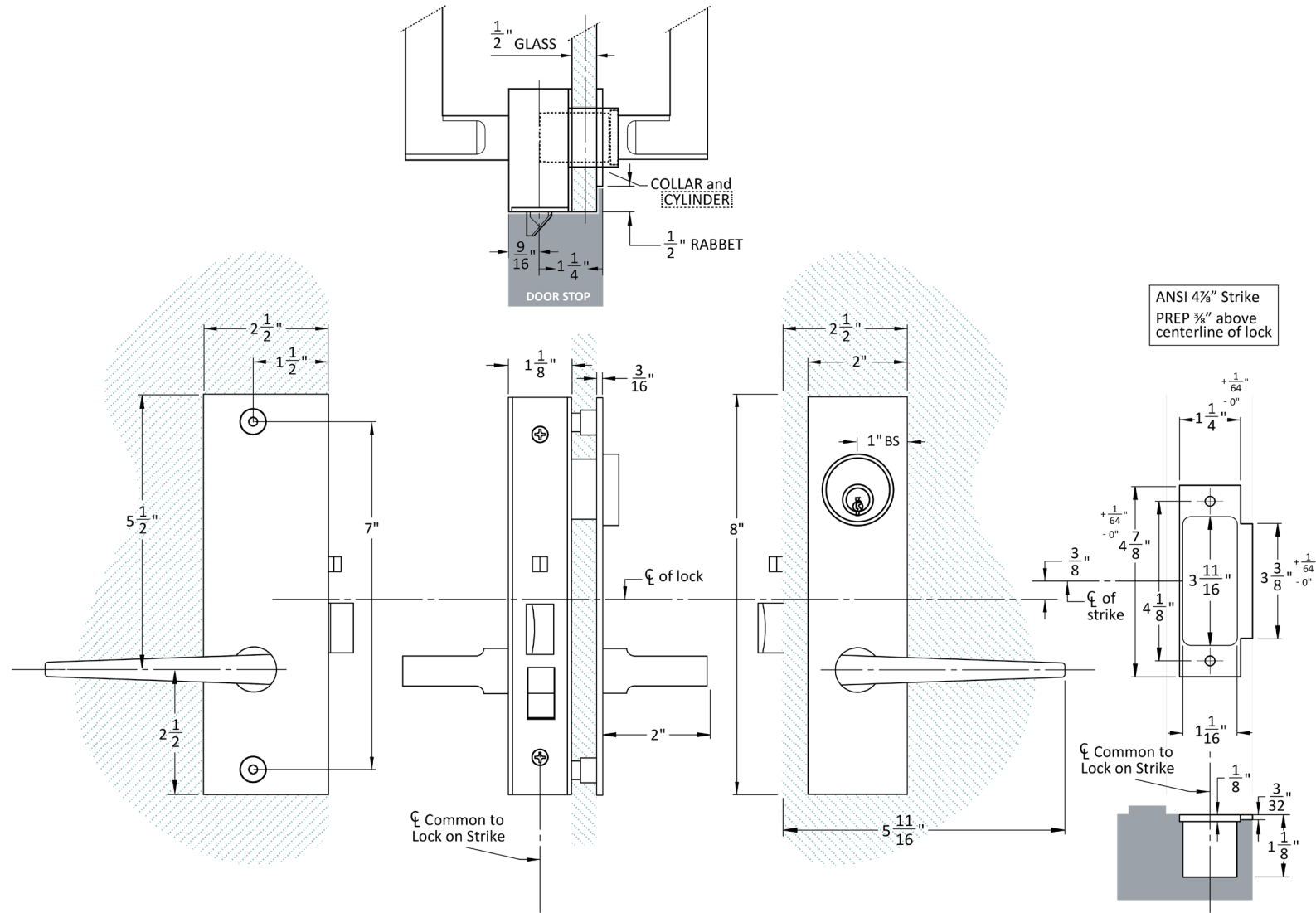

**GR8656 ENTRANCE FUNCTION WITH 18L LEVERS
(other levers available)**

GR86 Rabbeted Glass Patch Dimensions



INSWING
1-1/2" Cylinder Length
3/8" Collar

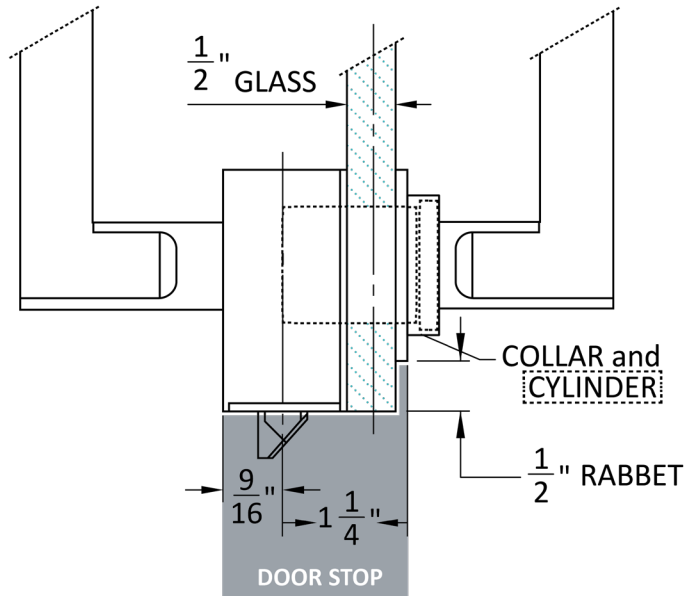

OUTSWING
1-1/2" Cylinder Length
1" Collar

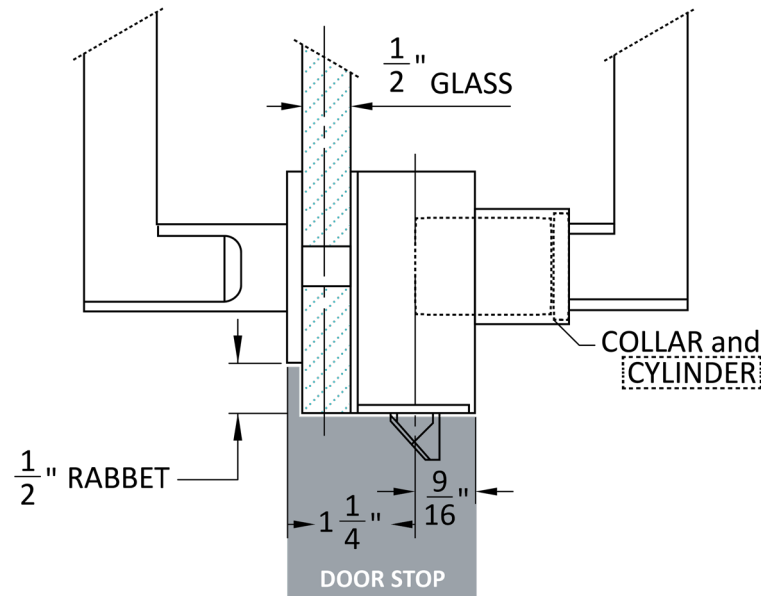

CYLINDER GUIDELINES		
Cylinder Length	Collar Size	
	Inswing	Outswing
3/4"	N/A	3/8"
1"		1/2"
1-1/8"		5/8"
1-1/4"		3/4"
1-3/8"	1/8"	7/8"
1-1/2"	3/8"	1"

GR86 Series Functions

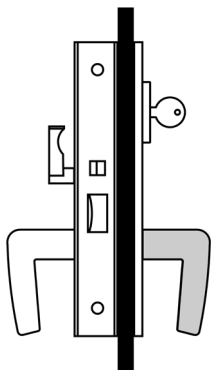

GR8624 ENTRANCE

Latch bolt by lever either side.

Deadbolt by key outside and turn piece inside.

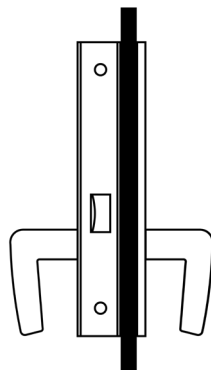

GR8625 PASSAGE

Latch bolt by lever either side.

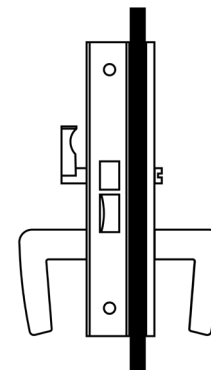

GR8639 PRIVACY

Latch bolt by lever either side.

Deadbolt by turn piece inside and optional emergency key outside.

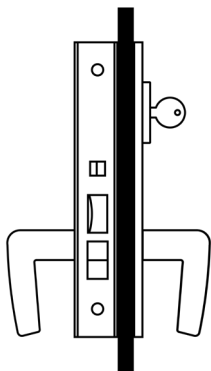

GR8656 ENTRANCE OR OFFICE

Latch bolt by key outside and handle either side unless outside handle is locked by toggle-action stop.

Auxiliary latch deadlocks latch bolt.

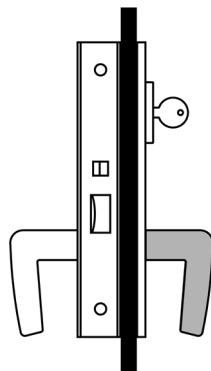

GR8659 STOREROOM

Latch by handle inside and key outside.

Outside handle always rigid.

Auxiliary latch deadlocks latch bolt.

GR86 Rabbeted Glass Template

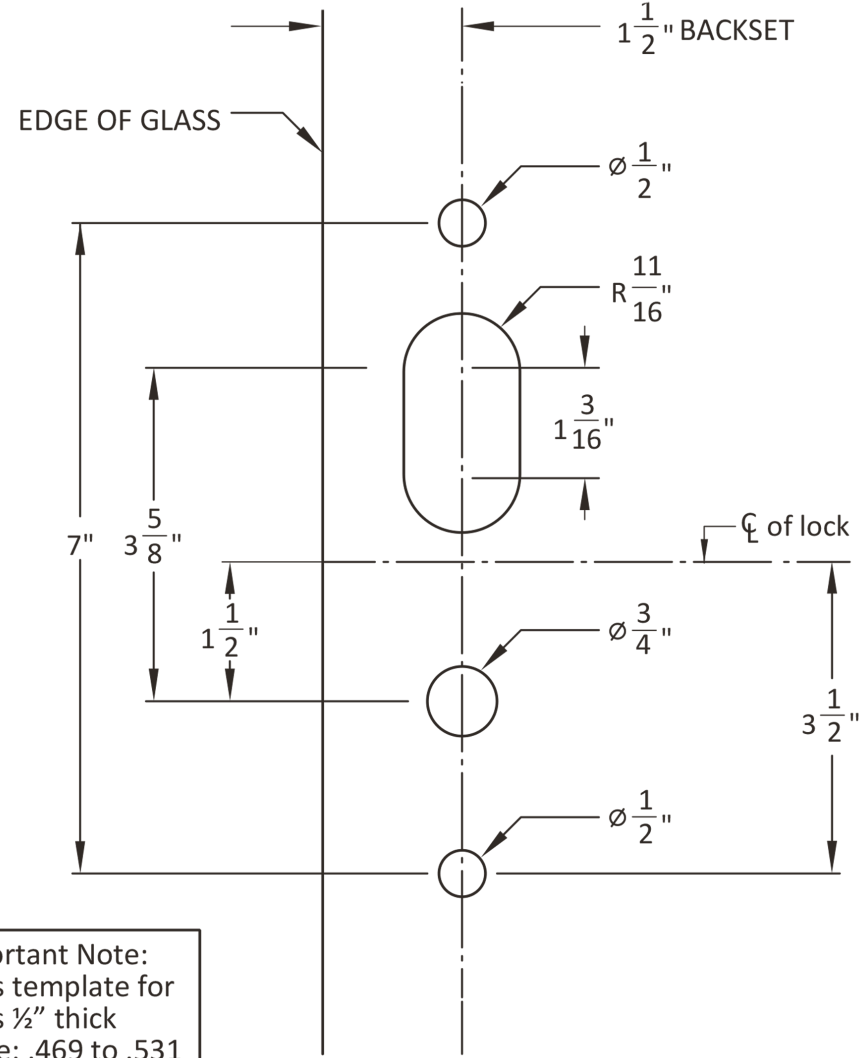

Important Note:
Glass template for
Glass 1/2" thick
range: .469 to .531

For use with:
GR8624
GR8625
GR8639
GR8656
GR8659

Accurate Lever Trim

18L LEVER

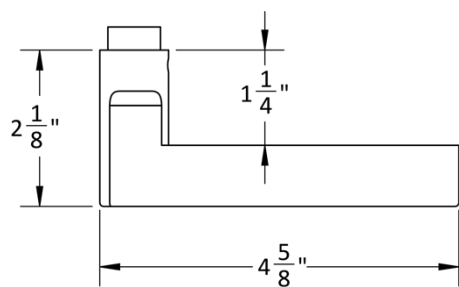

19L LEVER

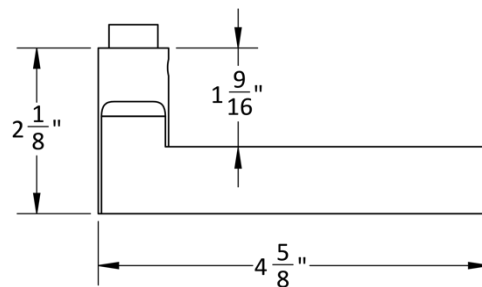

20L LEVER

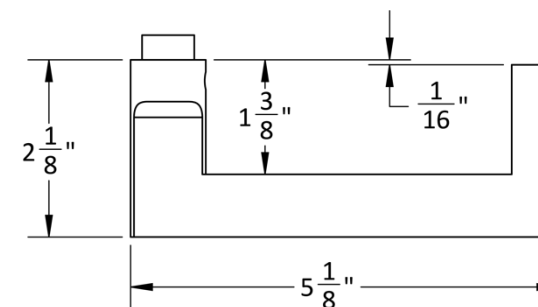
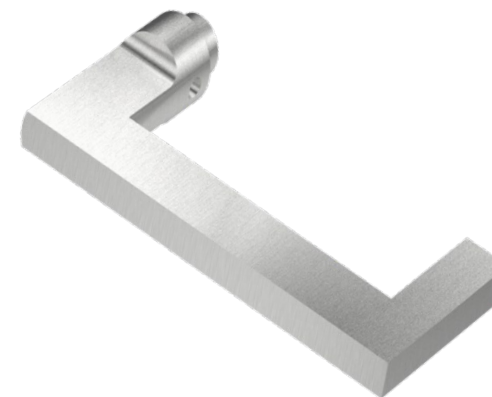

Accurate Lever Trim

21L LEVER

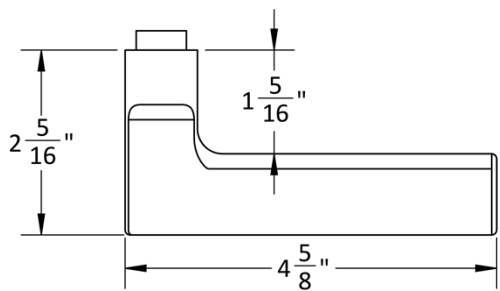

29L LEVER

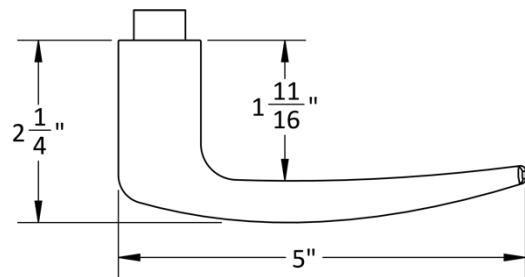

39L LEVER

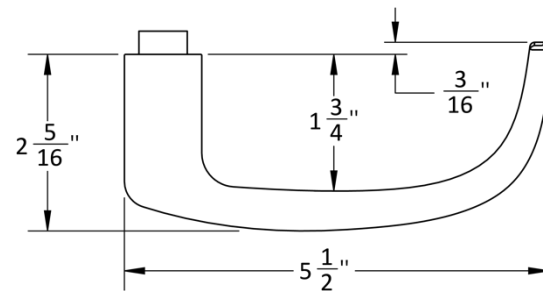

72L LEVER
Furnished Standard

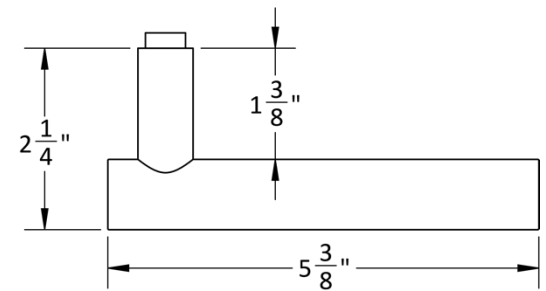

HOW TO SPECIFY

HANDING

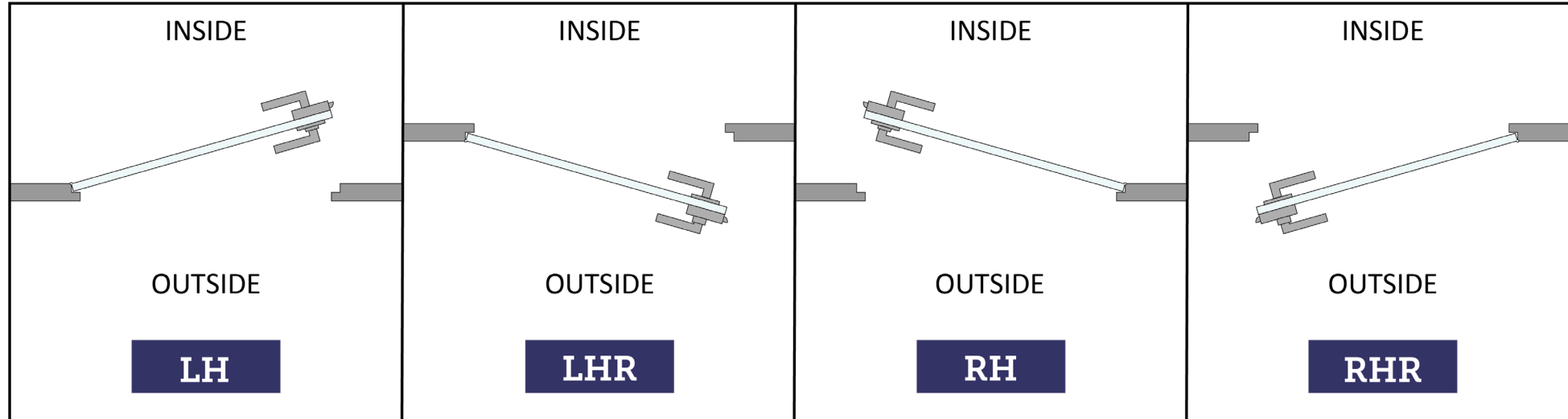

FINISHES

US28, ESN, US19

Other finishes available, please [contact us](#) for assistance.

CYLINDERS & KEYING

GR86 Series locks accept any standard American mortise cylinder with a straight cam (other cams may be required for functions not listed). For details on required cams and compatibility with other manufacturers' cylinders, please visit: [Accurate Support](#).

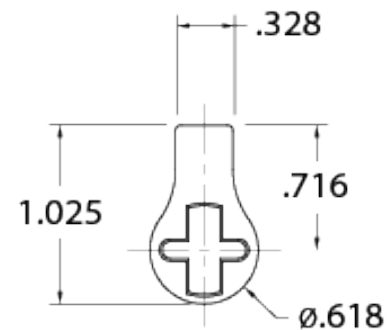

HOW TO SPECIFY

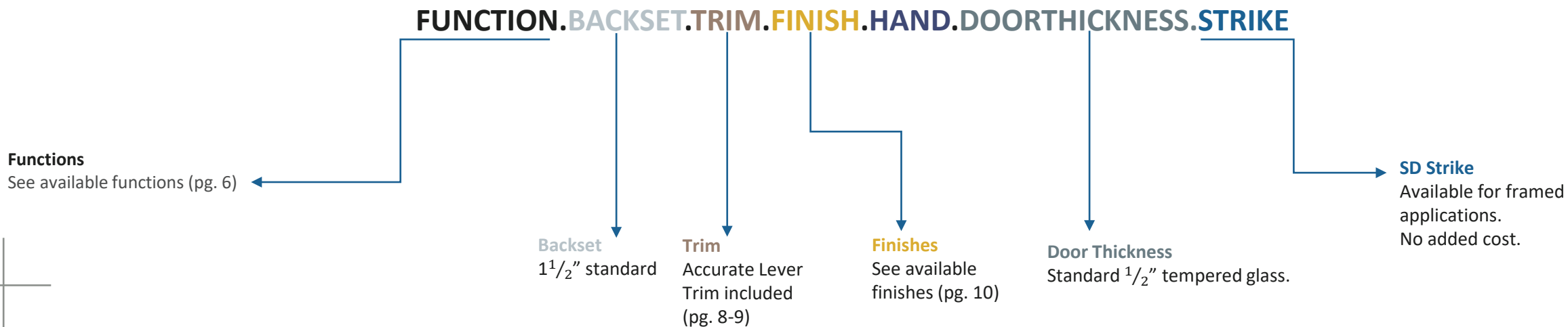

EXAMPLES

GR86 Entrance | Glass Wall

E.g.: GR8656.112.18L.US28.RH.1/2

GR86 Office | Aluminum Frame (4⁷/₈" Strike)

E.g.: GR8659.112.19L.US19.RH.1/2.SD

GR86 Passage

E.g.: GR8625.112.29L.ESN.RH.1/2

NOTES

- GR86 Series can be set up for levers by other manufacturers upon request.
- Access control applications available.
- Cylinders must be specific separately if required.

**ACCURATE LOCK & HARDWARE
MANUFACTURERS OF LOCKS AND
CUSTOM ARCHITECTURAL HARDWARE**

1 Annie Place | Stamford, CT 06902

P: 203.348.8865

F: 203.348.5234

E: sales@accuratelockandhardware.com

www.accuratelockandhardware.com



**AMERICAN CRAFTED
— SINCE 1972 —**