



ACCURATE

LOCK & HARDWARE

AMERICAN CRAFTED SINCE 1972

SL9100PDL Self-Latching Pocket Door Hardware Sets

INDUSTRY LEADING POCKET DOOR SOLUTIONS

SELF-LATCHING POCKET DOOR HARDWARE SET

SL9100PDL

The self-latching pocket door lock is an easy-to-operate privacy solution for pocket doors. The latch bolt is held back and released by pressing of a button or by sliding door closed against jamb. The door self latches whether latch is projected or retracted. When door hits the frame, the latch projects and latches.

SL9100PDL

BACKSETS: 2¹/₂" , 2³/₄" other backsets available as a special order.

DOOR THICKNESS: Available with 1" front for 1-3/8" thick doors or 1-3/4" thick doors. Designed for pocket doors.

APPLICATION: Latch bolt functions like an edge pull when projected. Deadbolt available for locking/extra security (see function list). Single action egress allowing unlocking and sliding the door open in one operation.

TRIM: Supplied with Accurate's SLFT Flush Pulls.



SL9100

SL9100PDL Dimensions

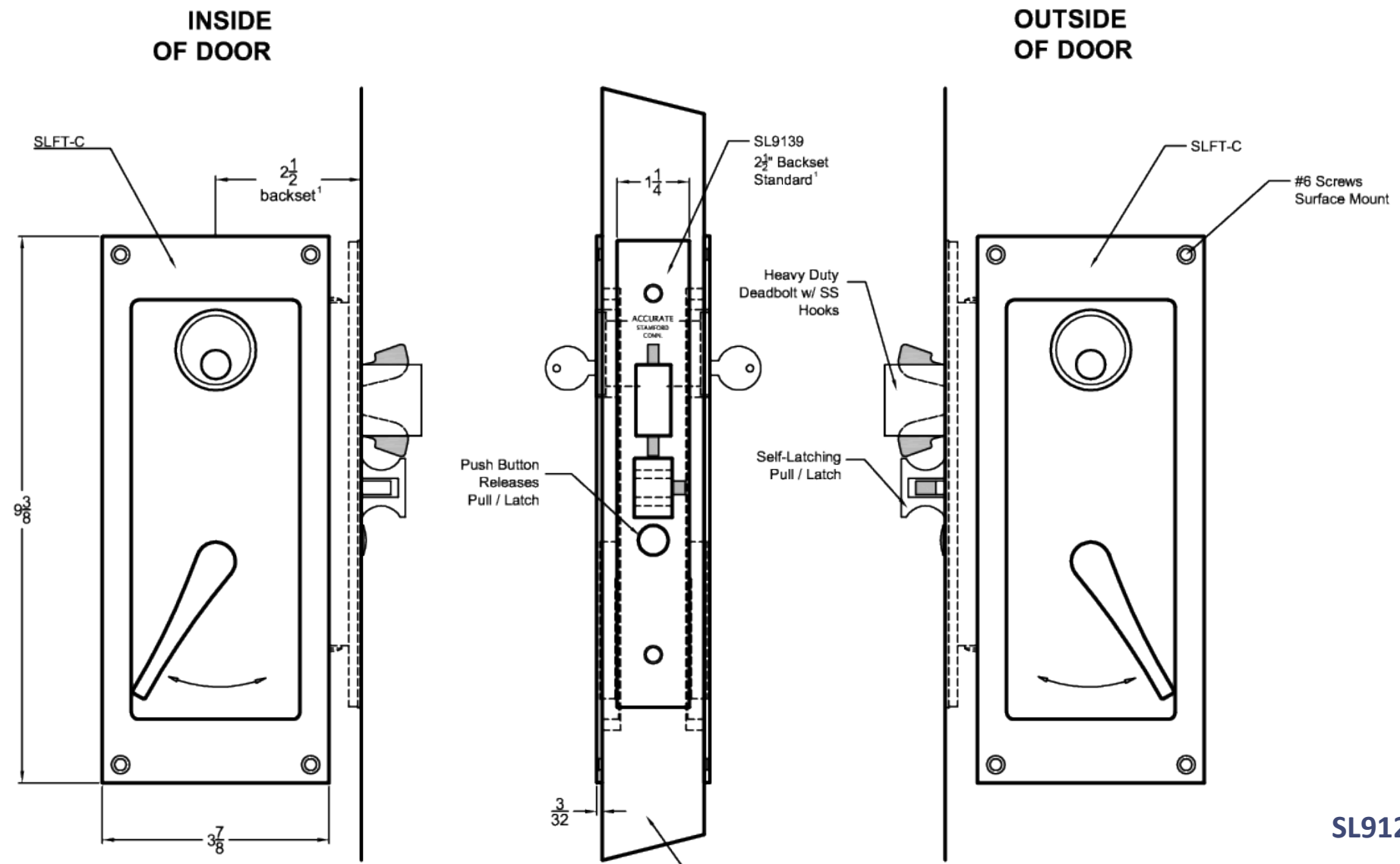

SL9122PDL

SL9100PDL FUNCTIONS

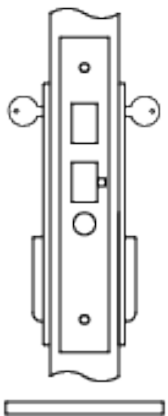

SL9122PDL STORE DOOR LOCK

Latch bolt by flush pull either side.
Deadbolt by key either side.
No emergency egress.

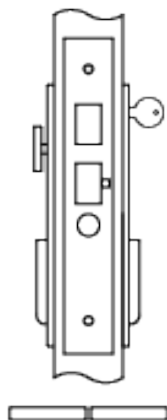

SL9124PDL DORMITORY

Latch bolt by flush pull either side.
Deadbolt by key outside, thumb turn inside.
Turn of inside handle retracts latch and deadbolt simultaneously, automatically unlocking outside flush pull.

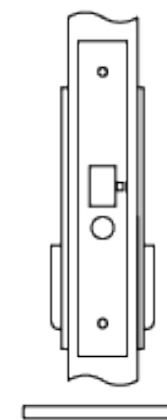

SL9125PDL PASSAGE

Latch bolt by flush pull either side.

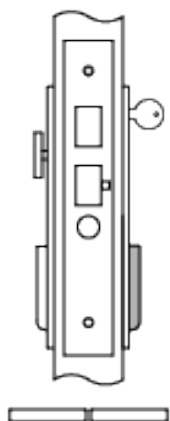

SL9134PDL HOTEL

Latch bolt by flush pull inside and guest/master key outside.
Outside flush pull always RIGID.
Deadbolt by turn piece inside.
Turn of inside handle retracts latch and deadbolt simultaneously.

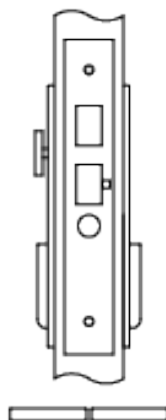

SL9139PDL PRIVACY

Latch bolt by flush pull either side.
Deadbolt by thumb turn and optional emergency coin turn outside.
Turn of inside handle retracts latch and deadbolt simultaneously automatically unlocking outside flush pull.

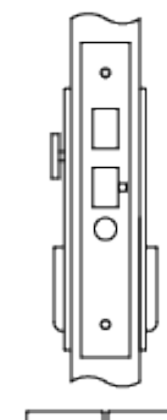

SL9139PDLi PRIVACY x INDICATOR

Latch bolt by flush pull either side.
Deadbolt by thumb turn and emergency coin turn with indicator outside.
Turn of inside handle retracts latch and deadbolt simultaneously, automatically unlocking outside flush pull

SL9100PDL FUNCTIONS

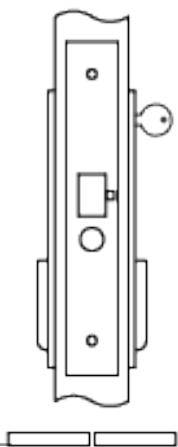

SL9145PDL CLASSROOM

Latch bolt by key outside and flush pull either side unless outside flush pull is locked by key.

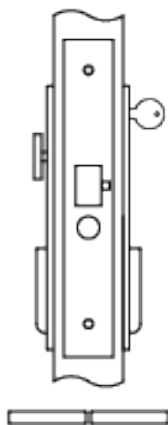

SL9153PDL OFFICE

Latch bolt by key outside and flush pull either side unless outside lever is locked by thumb turn or key.
Key or thumb turn locks or unlocks outside flush pull.

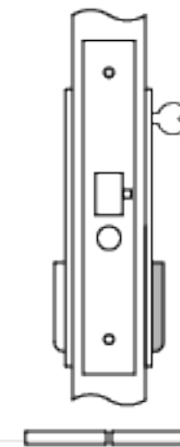

SL9159PDL STOREROOM

Latch by lever inside and key outside.
Outside flush pull always rigid.

SL9100PDL Standard Trim

SLFT-C

Flush Pull with
Cylinder Cutout



SLFT-T

Flush Pull with
Thumb Turn

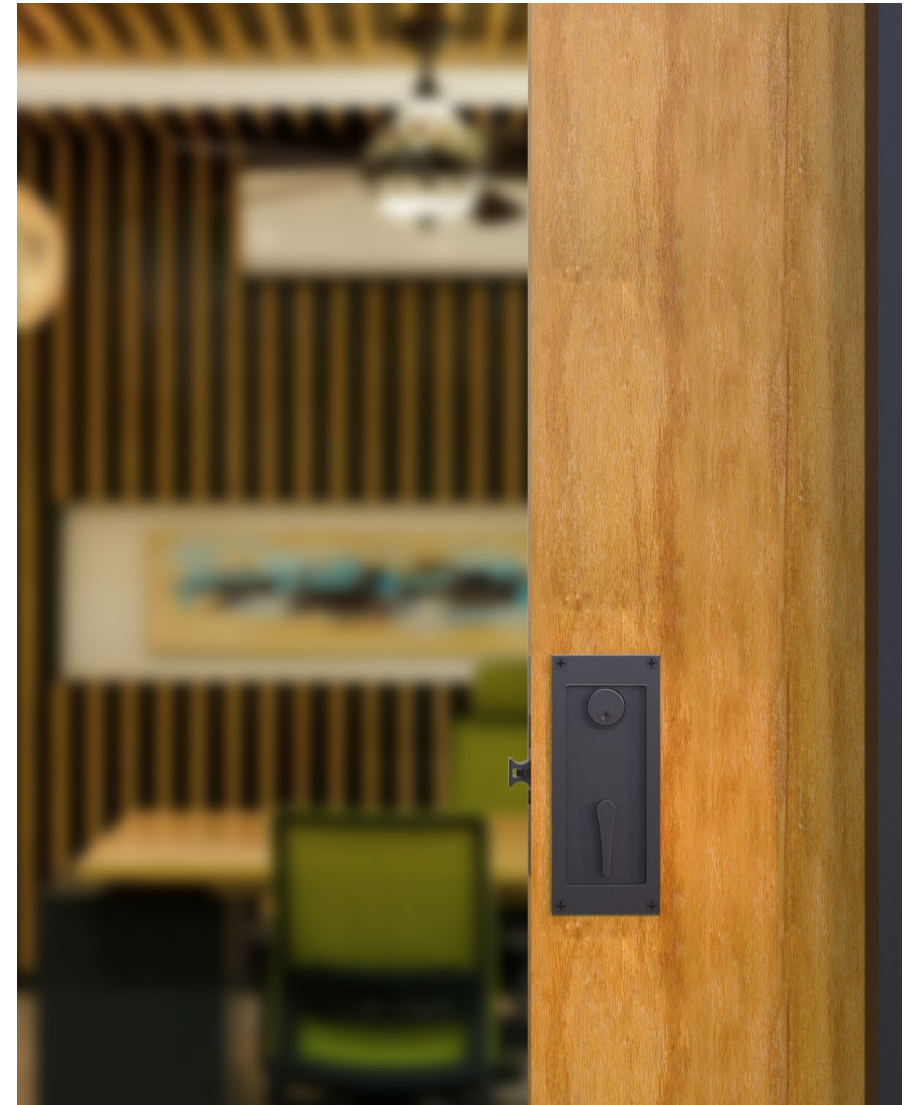
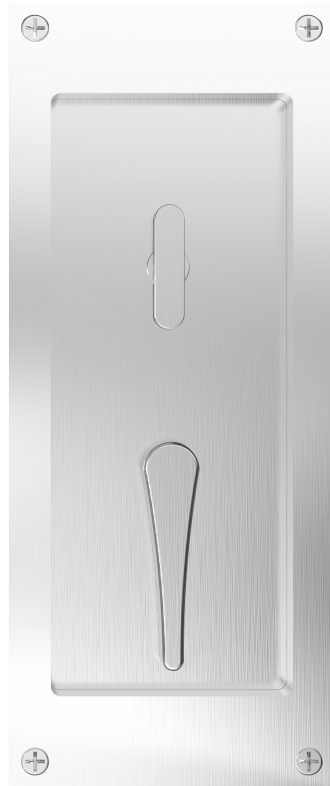

HOW TO SPECIFY

HANDING

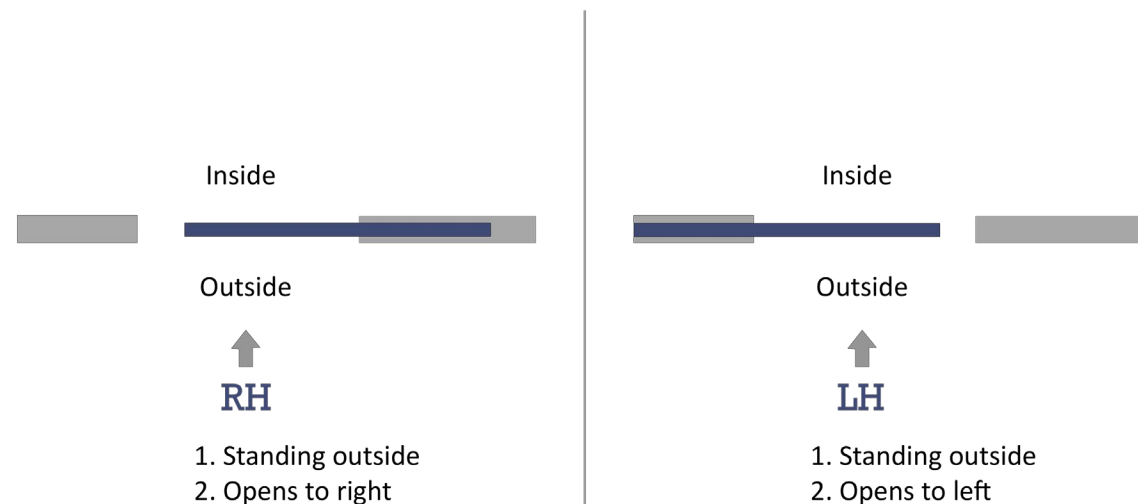

FINISHES

GROUP 1: US4, US4NL, US32D*, US26D

GROUP 2: US3, US3NL, US26, US32*, US9*, US10*, US10B, US14, US15, US19

GROUP 3: BN, BB, TN, TB, DURO, ESN, US15A, US5

* Trim options (including Accurate Levers) may not be available in US32D, US32, US9, or US10 finish. Please call for assistance.

To view example of finishes visit: [Accurate Finishes](#).

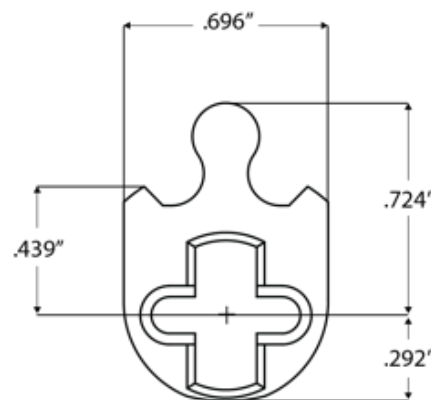

CYLINDERS & KEYING

SL9100PDL Series locks accept any standard American mortise cylinder. For details on required cams and compatibility with other manufacturers' cylinders, please visit: [Accurate Support](#).



HOW TO SPECIFY

FUNCTION.BACKSET.FINISH.HAND.DOORTHICKNESS

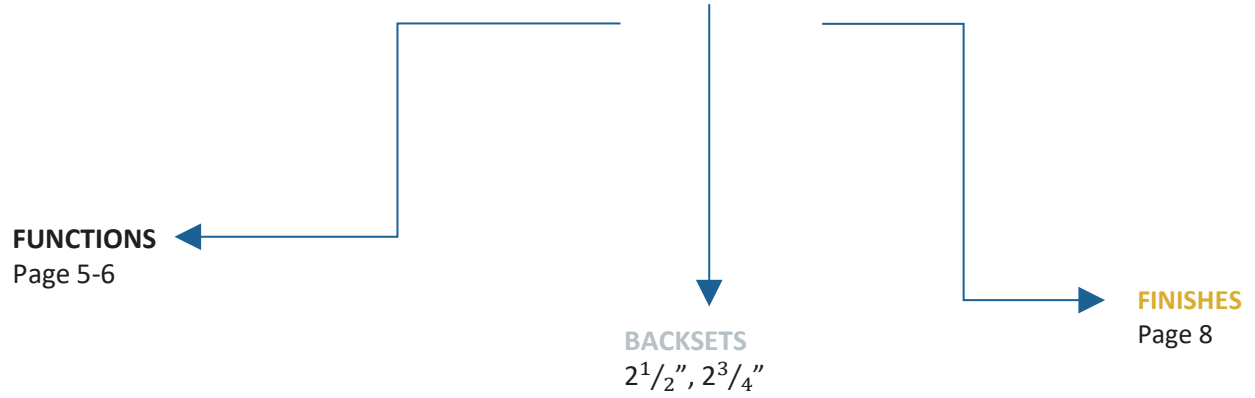

EXAMPLES

Self-Latching PDL Set | Passage
 E.g.: SL9125PDL.212.US26D.RH.134

Self-Latching PDL Set | Privacy with Indicator
 E.g.: SL9139PDLi.234.US4.LH.134

Self-Latching PDL Set | Classroom
 E.g.: SL9145PDL.234.US26D.RH.134

SPECIAL OPTIONS AVAILABLE

- Other backsets, door thicknesses and custom finishes available
- Access control applications

**ACCURATE LOCK & HARDWARE
MANUFACTURERS OF LOCKS AND
CUSTOM ARCHITECTURAL HARDWARE**

1 Annie Place | Stamford, CT 06902

P: 203.348.8865

F: 203.348.5234

E: sales@accuratelockandhardware.com

www.accuratelockandhardware.com



AMERICAN CRAFTED
— SINCE 1972 —