

DMSB

Standard Regulations for Rally Series

(As at: 02.03.2023)

Name of the Series:

ADAC Opel e-Rally Cup 2023

DMSB Visa:

XXX

Status of the Series/of the Events: National A

Promoter/Organisation: ADAC e.V.
Ressort Motorsport
Hansastraße 19
D - 80686 München

Contact: Timo Lewerenz
Phone: +49 89 7676 4410
Mobile: +49 171 5555 417
Homepage: www.adac-motorsport.de
E-Mail: timo.lewerenz@adac.de

Index

Part 1: Sporting Regulations

- 1. Introduction**
- 2. Organisation**
 - 2.1 Details of the Titles and Championships of the Series
 - 2.2 Name of the Parent ASN
 - 2.3 ASN Visa
 - 2.4 Name of the Organiser/Promoter, Address and Contact
 - 2.5 Organising Committee
 - 2.6 Permanent DMSB Officials
 - 2.7 List of Officials
- 3. Regulations and Legal Basis of the Series**
 - 3.1 Official language
 - 3.2 Responsibility, Modification of the Regulations, Cancellation of the Event
- 4. Entries**
 - 4.1 Registrations/Entries, Entry closing Date and Obligation to Participate
 - 4.2 Change of Driver/Co-driver
 - 4.3 Entry Fee for the Season and per Event
 - 4.4 Services included in the Registration Fee
 - 4.5 Start Numbers
- 5. Licences**
 - 5.1 Required Licence Grades
 - 5.2 Conditions for Competitors outside their National Territory
- 6. Insurance, Approval, Exclusion of Liability and Waiver**
 - 6.1 Organiser's/Promoter's Insurance
 - 6.2 Exclusion of Liability of Competitor, Driver and Co-driver
 - 6.3 Liability Waiver of the Vehicle Owner
- 7. Events**
 - 7.1 Calendar ADAC Opel e-Rally Cup Saison 2021:
 - 7.2 Running of the Events
- 8. Classification**
 - 8.1 Classification and Points Allocation
 - 8.2 Dead heat
- 9. Administrative Checks**
- 10. Scrutineering / Technical Checks**
 - 10.1 Repairs, Sealing and Marking of Vehicle Components
 - 10.2 Timetable Scrutineering / Technical Checks
- 11. Controls**
- 12. Running of the Events / Programme**
- 13. Title, Prize Money and Trophies**
 - 13.1 Title Overall Winner

- 13.2 Prize Money and Trophies
- 13.3 Promotion of Young Talents

- 14. Protests and Appeals**
- 15. Exclusion of the Jurisdiction of a Court and Limitation of Liability**
- 16. TV Rights / Advertising and Television Rights**
- 17. Specific Regulations**

Part 2: Technical Regulations

- 1. Technical Regulations of the Series**
 - 1.1 Summary of Groups/Classes
 - 1.2 The Technical Regulations are based on
 - 1.3 General / Preamble
 - 1.4 Driver and Co-driver Equipment
 - 1.5 General Provisions, Permitted Modifications and Installations
 - 1.6 Vehicle Minimum Weight and Ballast
 - 1.7 Noise Regulations
 - 1.8 Advertising on the Driver's Equipment /the Competition Car and Start Numbers
 - 1.9 Safety Equipment
 - 1.10 Recharging the HV Battery
 - 1.11 Technical Definitions
- 2. Special Technical Regulations**
 - 2.1 General
 - 2.2 Drive Unit
 - 2.3 HV Battery
 - 2.4 Brakes
 - 2.5 Steering
 - 2.6 Wheel Suspension
 - 2.7 Wheels (disc + rim) and Tyres
 - 2.8 Bodywork and Dimensions
 - 2.9 Electrical Equipment
 - 2.10 Data Transmission
 - 2.11 Lights/Additional Headlamps
 - 2.12 Miscellaneous

Part 3: Attachments/Drawings

- Attachment 1 Sticker instructions vehicles /sponsor areas driver/co-driver overalls
- Attachment 2 Suspension adjustment front axle
- Attachment 3 Safety Displays

These regulations consist of 28 pages incl. 3 attachments.

Part 1: Sporting Regulations

1. Introduction

The series ADAC Opel e-Rally Cup will be run in compliance with the provisions of the International Sporting Code and its appendices and of the national Sporting Regulations issued by the DMSB. It will moreover run in compliance with the Sporting and Technical Regulations of the series.

The competitions will be organised in accordance with the DMSB Event and Rally Regulations, unless otherwise specified in the following or in the Supplementary Regulations of the respective event.

The series is supported by the following organisations/companies:
Opel Automobile GmbH

2. Organisation

2.1 Details of the Titles and Championships of the Series

The ADAC e.V., hereinafter also referred to as series promoter, organises the ADAC Opel e-Rally Cup for the year 2023.

2.2 Name of the Parent ASN

DMSB – Deutscher Motor Sport Bund e.V.
Hahnstraße 70, D-60528 Frankfurt
Homepage: www.dmsb.de
E-Mail: info@dmsb.de

2.3 ASN Visa

The series with the present Sporting and Technical Regulations has been approved by the Deutscher Motor Sport Bund with date of 03.03.2021 and registration no.: 557/21.

2.4 Name of the Organiser/Promoter, Address and Contact

ADAC e.V.
Hansastraße 19
D-80686 München
Contact: Timo Lewerenz
Phone: +49 89 7676 4410
Mobile: +49 171 5555 417
E-Mail: timo.lewerenz@adac.de

2.5 Organising Committee

Head of ADAC Automobile Sport:	Andreas Bachmeier
Director Opel Motorsport	Jörg Schrott
Series Manager ADAC Opel e-Rally Cup:	Timo Lewerenz

2.6 Permanent DMSB Officials

Chairmen of the Stewards

The respective Chairmen of the Stewards are listed in the corresponding Supplementary Regulations of the events.

Chief Scrutineer

Ralf Kleebusch	SPA 1039795
Florian Wilke	SPA 1152455

2.7 List of Officials

The officials and delegates are listed in the corresponding Supplementary Regulations of the events.

3. Regulations and Legal Basis of the Series

The series is governed by the following regulations:

- FIA International Sporting Code (ISC) including Appendices
- DMSB Event Regulations
- DMSB Rally Regulations
- DMSB Licence Regulations
- DMSB Judicial and Disciplinary Rules (“RuVO”)
- Decisions and regulations issued by the DMSB
- DMSB Environmental Rules
- Anti-Doping Regulations of the National and the International Anti-Doping Agencies (WADA/NADA-Code) as well as Anti-Doping Regulations of the FIA
- Sporting and Technical Regulations of this series including DMSB approved amendments and supplements (Bulletins)
- Supplementary Regulations of the events including any amendments and supplements (Bulletins)
- Road Traffic Licensing Regulations (StVZO) of the Federal Republic of Germany
- the FIA Code of Ethics and the FIA Code of Conduct and the DMSB Code of Ethics
- any other regulations of the FIA and the DMSB

3.1 Official language

The official language is German. Only the German, DMSB approved regulation text is binding.

3.2 Responsibility, Modification of the Regulations, Cancellation of the Event

Participants (competitors, drivers, codrivers, passengers, vehicle registered keepers and vehicle owners) take part in the event at their own risk. They bear the sole responsibility under civil and criminal law for any damage caused by them or by the vehicle used by them, unless an exclusion of liability is agreed in accordance with these Regulations.

In principle, the regulations may only be changed by the approving body. From the beginning of the event, changes in the form of bulletins may only be made by the stewards of the event, but only if this is necessary for reasons of safety and / or force majeure or due to official orders or if the information contained in the invitation to enter contains obvious errors with regard to course length, race duration, number of laps and stewards.

The series organiser reserves the right to make any necessary changes to the present Regulations due to force majeure or for safety reasons or as ordered by the authorities, or to cancel the series or individual competitions should this be necessary due to extraordinary circumstances, without any obligations for indemnification, with the exception of intent and gross negligence. In all other respects the organiser is only liable as far as no exclusion of liability is mentioned in the Regulations and entry.

4. Entries

4.1 Registrations/Entries, Entry closing Date and Obligation to Participate

The competitor or driver/co-driver must register in the ADAC Opel e-Rally Cup by **Friday, 31.03.2023**, using the registration form issued by the series organiser. The series organiser reserves the right to accept applications received later.

The fully completed and signed application form must be sent to the following address:

ADAC e.V.
Timo Lewerenz
Ressort Motorsport
Hansastraße 19
D-80686 München

The registration shall be deemed accepted only after receipt of the complete registration as well as receipt of the registration fee and upon written confirmation by the series organiser. Only after the confirmation are the competitors or drivers/co-drivers entitled to receive points and prize money. The series organiser reserves the right to refuse a registration with indication of reasons.

Only competitors or drivers/co-drivers who have registered with an Opel Corsa-e rally vehicle in accordance with the registration conditions may participate in the ADAC Opel e-Rally Cup 2023.

By registering, the competitor and driver/co-driver instruct and authorise the series organiser to pay the entry fee on their behalf for the events at which scoring runs for the ADAC Opel e-Rally Cup are held. Accordingly, the fully completed entry documents must be submitted by the competitor or driver/co-driver independently in electronic form at the latest one week before the entry deadline of the organiser (in the case of a reduced entry deadline of the organiser, the first deadline shall apply) to both the organiser and the driver/co-driver.

For this purpose, please send a copy of the entry documents by e-mail to: tanja@rallye.services
Late receipt of the entry documents by the organiser of the rally or by the series organiser will be

charged with a late entry fee of 50,00 €. Only until the entry deadline of the respective event are entitled to participate in the event.

By registering, the entrant or driver/co-driver undertakes to participate in all scoring runs, except in cases of force majeure.

A claim of force majeure at an event must be submitted to the series coordinator no later than three days before the start of the respective competition. The series coordinator will then decide whether to grant the request for exemption. If this procedure is disregarded, the respective driver and/or co-driver may be fined.

If a participant registers and still does not start in all runs of the series (except in cases of force majeure), the claim for a refund of the entry fee is generally forfeited. In addition, in this case a fine of 1.000,00 €, imposed by the organising committee.

The participation of the 1st driver is decisive, the 2nd driver (co-driver) may be changed.

If a rally has to be cancelled due to force majeure, the participant will not be refunded any amounts or partial amounts of the registration fee.

The series organiser reserves the right not to hold the series if there are less than eight registered participants.

4.2 Change of Driver/Co-driver

Should a driver or co-driver change during the season, this change must be promptly notified to the series organiser.

4.3 Entry Fee for the Season and per Event

The registration fee as well as any deposit are due according to the registration. The following registration fee is to be paid:

A registration fee of **€ 7,500.00 plus VAT** per participating vehicle is payable to ADAC. The registration fee is due upon registration for the ADAC Opel e-Rally cup 2023

If a competitor or driver/co-driver does not participate in the series or in individual rounds of the series despite registration, he is not entitled to a refund of the entry fee.

4.4 Services included in the Registration Fee

Competitors or drivers/co-drivers whose registration has been confirmed by the series organiser will receive the following services with the confirmation of the registration:

- Payment of entry fees to the respective qualifying rounds of the ADAC Opel e-Rally Cup 2023.
- Prize money entitlement for the respective qualifying rounds of the ADAC Opel e-Rally Cup 2023
- Uniform Cup overall for driver and co-driver*
- Team clothing for driver and co-driver*
- Service tent with groundsheet and service banner*
- Catering package for 4 persons
- Free charging of the vehicles during the respective qualifying rounds

***applies only to new entrants in the ADAC Opel e-Rally Cup 2023**

4.5 Start Numbers

In principle, the series organiser will allocate permanent start numbers to the teams for the entire season.

5. Licences

5.1 Required Licence Grades

a) Drivers

Drivers must hold an International Candidate and Driver Licence of the DMSB or another ASN affiliated to the FIA, valid for the year 2023, with the levels:

- International Licence Level A (ITA)*
- International Licence Level B (ITB)*
- International Licence Level C-Road (ITC-R)
- International Licence Level D-Road (ITD-R)

*with ASN approval for rallying

Drivers must hold a DMSB or other FIA affiliated ASN National Applicant and Driver Licence valid for the year 2023, with the level:

National Licence Level A

b) Co-drivers

Co-drivers must be in possession of an International Applicant and Driver Licence of the DMSB or another ASN affiliated to the FIA valid for the year 2023, with the levels:

- International Licence Level A (ITA)*
- International Licence Level B (ITB)*
- International Licence Level C-Road (ITC-R)
- International Licence Level D-Road (ITD-R)

*with ASN-approval for rallying

Co-drivers must hold a DMSB or other FIA affiliated ASN National Candidate and Driver Licence valid for the year 2023, with the level:

National Licence Level A

c) Competitors

Competitors registering with the driver must hold an international company or international club competitor license issued by the DMSB or by another ASN affiliated to the FIA, valid for the year 2023, and must have paid the registration fee.

d) DMSB-Sponsor-Card

Sponsors or name sponsors who wish to be mentioned in the official program as well as in the entry, start and result lists in addition to the driver's name, but without assuming the responsibility of a competitor at the same time, can achieve this by purchasing a "DMSB Sponsor Card" for companies, clubs, teams.

e) Guest Teams

The series organiser may accept guest teams with a valid

International Competitor and Driver Licence according to Art. 5.1

to the qualifying rounds.

If they meet the conditions of the Series Regulations as well as of the Supplementary Regulations for the respective event, they can participate outside the points and prize money classification. The registered participants have priority in the admission to the start. The registered participants will move up in the classifications for the points and prize money allocations. A guest starter may be refused by the series organiser with indication of reasons.

f) Age Regulations

In accordance with the current DMSB Licence Regulations.

5.2 Conditions for Competitors outside their National Territory

For all events, foreign competitors/drivers/co-drivers require the approval of their own ASN. This ASN start permission must be presented by the competitor/driver at administrative checks in German or in English language.

At events with status National A, DMSB licence holders as well as licence holders of another ASN affiliated to the FIA are eligible to participate and receive points for this series.

In the case of prize money payable to foreign drivers and teams (competitors) (for races taking place in Germany), German income tax must be withheld and paid to the tax office.

Applicable percentages according to § 50 EStG

- up to € 250,- no tax deduction

- over € 250,- 15,825 % tax deduction

Drivers/competitors residing in another country with which a double taxation agreement exists may submit an "Application in accordance with § 50d EStG for the issue of an exemption certificate for an artistic, sporting, artistic or similar performance in Germany and / or reimbursement of German withholding tax in accordance with § 50a EStG on the basis of the double taxation agreement of the Federal Republic of Germany".

If it is not clear to ADAC in the case of a driver / competitor from Germany whether he/she is also resident there for tax purposes, ADAC can only waive the deduction of tax if a certificate of residence from his/her tax office is submitted.

6. Insurance, Approval, Exclusion of Liability and Waiver

6.1 Organiser's/Promoter's Insurance

In accordance with the DMSB Event Regulations.

6.2 Exclusion of Liability of Competitor, Driver and Co-driver

In accordance with the DMSB Event Regulations.

7. Events

7.1 Calendar ADAC Opel e-Rally Cup:

05./06.05.	ADAC Rallye Sulingen, Sulingen	D
02./03.06.	Rallye du Chablais, Aigle	CH
17./18.06.	Rallye Vosges Grand-Est, Gérardmer	F
14./15.07.	Rallye Weiz, Weiz	A
18./19.08.	ADAC Saarland-Pfalz Rallye, St. Wendel	D
02./03.09.	Rallye Mont-Blanc, Morzine	F
29./30.09.	ADAC Rallye Stemweder Berg, Lübbecke	D
27.-29.10.	Central European Rally, Passau	D/A/CZ

Only the above-mentioned events will be considered for the series. Only the event Saturdays are listed. The exact number of event days will be specified in the respective Supplementary Event Regulations.

In agreement between the series promoter and the organiser, one special stage will be defined as the Power Stage at each event.

7.2 Running of the Events

7.2.1 General

The provisions of the FIA / DMSB rally regulations shall generally apply. Special procedures will be outlined in the respective Supplementary Event Regulations.

7.2.2 Official Dates

Mandatory dates (e.g. Cup Meeting) on the event weekend will be notified to the participants as soon as possible in writing or by publication on the Official Notice Board or in the Cup-Info. Non-participation or late appearance will result in a fine of 100,- €, pronounced by the organising committee. In case of repeated infringements, the participant may be excluded from the ADAC Opel e-Rally Cup by the organising committee.

7.2.3 Prizegiving

There will be one prizegiving ceremony per event. Exceptions will be communicated in advance by the organiser or the series promoter. Drivers and co-drivers finishing in the top five positions at an event are required to attend the prizegiving ceremonies. The ADAC reserves the right to release drivers or co-drivers from this obligation at individual events for special reasons.

Participants finishing in the top five at an event of the ADAC Opel e-Rally Cup are obliged to wear the official ADAC Opel e-Rally Cup team clothing at the prizegiving ceremony. Failure to do so will result in a fine of 100,- €, pronounced by the organising committee.

Participants finishing in the top ten at an event of the ADAC Opel e-Rally Cup will receive the corresponding prize money after the event by bank transfer to the bank account specified in the registration.

7.2.4 Service Park

The corresponding spaces in the respective service park will be allocated centrally by ADAC.

7.2.5 Retirements

In case of a retirement, the teams must contact the series promoter as soon as possible and inform about the retirement and about the reason for the retirement.

7.2.6 Re-start after retirement

In addition to the restart regulations according to the event supplementary regulations, the following regulation applies.

In case of a technical failure, a team is allowed to restart after a subsequent regrouping under the following conditions:

- after the retirement, the intention to restart is communicated to the Chief scrutineer of the ADAC Opel e-Rally Cup.
- Before a repair, the cars may be brought directly to their service area and wait under parc fermé conditions until the Chief scrutineer gives permission for the repair or not.
- After repairs have been carried out and before leaving the service area, the vehicle must be presented again to the Chief Scrutineer, who will give permission to restart.

Drivers who restart will receive a time penalty.

A time penalty of 10 minutes will be given for each special stage or Super Special Stage not completed.

A driving time will be allocated for each stage not completed, including the stage on which the drivers have retired. This corresponds to the fastest time of the respective special stage of the respective class plus the time penalty.

8. Classification

8.1 Classification and Points Allocation

A separate classification for the ADAC Opel e-Rally Cup will be established at the events. Points and prize money will only be awarded to the nominated drivers of a team if they drive the special stages as the vehicle driver (1st driver).

The team (driver and co-driver) will only be classified together if the co-driver has competed with the same driver in all the rounds in which the driver is classified.

The classification for the ADAC Opel e-Rally Cup is based on the official result lists of the respective event. All events according to Art. 7.1 will be taken into consideration, there is no void result.

The following points will be awarded at each event:

Position	1	2	3	4	5	6	7	8	9	10	11	12	13	14	15
Points	30	25	22	19	16	14	12	10	8	6	5	4	3	2	1

The top five drivers of the Power Stage of each event will receive 5, 4, 3, 2, 1 additional points for the ADAC Opel e-Rally Cup classification.

In cases where, due to an obvious oversight or error, a subsequent correction is necessary after the publication of the championship or series standings by the series organiser, such correction may be applied by the series organiser. Complaints regarding the series classification shall be addressed to the series organiser. There is no right of appeal against the decision of the series organiser.

8.2 Dead heat

In the event of a tie (*ex aequo*), the greater number of first, then second and possibly further places achieved in all competitions of the ADAC Opel e-Rally Cup in the current season shall be decisive. In the event of a further tie, the better position in the last competition will decide.

9. Administrative Checks

In accordance with the respective Supplementary Regulations.

10. Scrutineering / Technical Checks

At scrutineering, the drivers or the persons appointed by them must present the competition vehicle and the mandatory driver's safety equipment. The vehicle must be presented in the configuration as it will be used in the competition (incl. start numbers and sticker regulations of the series) and must comply with the applicable technical regulations. The complete tracking system must be installed if prescribed in the respective Supplementary Regulations.

The following vehicle documents must be presented:

- Vehicle registration certificate or registration certificate part I
- Certificate of the rollcage
- DMSB motor vehicle passport (Kraftfahrzeugpass / KFP), for vehicles with registration in Germany
- SOS/OK board at least size DIN A3
- Rescue card

10.1 Repairs, Sealing and Marking of Vehicle Components

According to Art. 2.2 of the Technical Regulations in the present regulations.

10.2 Timetable Scrutineering / Technical Checks

According to the respective Supplementary Regulations.

10.3 Parc Fermé

The Parc Fermé will take place in the team tent. The vehicle must be marked with an appropriate sign on the rear window. The vehicle must stand on its wheels and the charging plug must be

plugged in. The service personnel of the charging technology must be granted access to the vehicles at all times.

11. Controls

The provisions of the DMSB Rally Regulations 2023 are applicable.

12. Running of the Events / Programme

See Supplementary Regulations of the respective event and/or Rally Guide.

13. Title, Prize Money and Trophies

13.1 Title Overall Winner

The title

ADAC Opel e-Rally Cup Winner 2023

will be awarded to the team/ the driver who have scored the highest number of points from all qualifying rounds of the ADAC Opel e-Rally Cup.

The title

ADAC Opel e-Rally Junior Cup Winner 2023

will be awarded to the team/ the driver who have scored the highest number of points from all qualifying rounds of the ADAC Opel e-Rally Junior Cup (participants up to and including 26 years of age / born in 1997 and younger).

The respective winner (incl. co-driver), the respective second and third placed winners undertake to accept the invitation to the ADAC SportGala or to a motor show, e.g. the Essen Motor Show, if applicable. The winner undertakes to make the winning vehicle available to the ADAC for the Essen Motor Show and for the ADAC SportGala free of charge .

13.2 Prize Money and Trophies

The following prize money will be awarded at each event to the drivers registered in the ADAC Opel eRally Cup:

Position	1	2	3	4	5	6	7	8	9	10
Gross amount €	1,500	1,250	1000	750	650	550	450	350	250	150

In addition, the top three drivers registered in the ADAC Opel e-Rally Junior Cup (participants up to and including 26 years of age / born in 1997 and younger) will receive the following prize money in the annual final classification:

Position	1	2	3
Gross amount €	15,000	10,000	5,000

All prize money includes VAT and will be paid out after each event to the competitors or drivers/teams according to the registration.

For administrative reasons, VAT can only be paid out if ADAC has received confirmation from the competitor or driver/team regarding their domestic entrepreneurial status by May 1, 2023.

Any outstanding financial claims against drivers/teams/competitors on the part of ADAC or Opel Automobile GmbH, the official equipment suppliers of the series, the spare parts supplier or the local organiser may be offset against the prize money.

According to the position in the overall classification of the annual ADAC Opel e-Rally Cup 2023 final standings, trophies will be awarded to the participants in the top three positions. The series organiser reserves the right to award further trophies.

13.3 Promotion of Young Talents

The ADAC e.V. and Opel Automobile GmbH intend to carry out or implement a junior development programme in the 2024 season with international participations in an Opel Corsa Rally4.

If the planned support programme is implemented in the 2024 season, a selection can be planned at the end of the 2023 season and the top three finishers of the ADAC Opel e-Rally Junior Cup as well as other talents from the series may be invited to participate.

After the final event, the details of the 2024 junior development programme will be announced.

14. Protests and Appeals

In the case of protests and appeals, the FIA International Sporting Code, the DMSB Event Regulations, the DMSB Legal and Procedural Regulations and, in the case of appeals to the FIA, the FIA Judicial and Disciplinary Rules shall apply.

Protest deposit - payable to the ASN having approved the event :
Status International: according to the respective Supplementary regulations.

Appeal deposit - payable to the DMSB: € 1,000.00

(Protest and appeal deposits are VAT-exempt)

15. Exclusion of the Jurisdiction of a Court and Limitation of Liability

In the case of decisions of the FIA, DMSB, their jurisdiction, the stewards, the series organiser or the organiser as a judge within the meaning of § 661 BGB (German Civil Code), any recourse to the courts is excluded.

No claims for compensation of any kind can be derived from measures and decisions of the DMSB or its sports jurisdiction as well as the representatives of the DMSB and the series organiser, except for intentional or grossly negligent cause of damage.

16. TV Rights / Advertising and Television Rights

All copyright and image rights are held by ADAC e.V. and Opel Automobile GmbH. All TV rights of the ADAC Opel e-Rally Cup, for terrestrial broadcast as well as for cable and satellite TV broadcast, all video rights and all rights for exploitation by all electronic media, including internet, are held by ADAC e.V. and Opel Automobile GmbH.

Any kind of recording, broadcasting, repetition or reproduction for commercial purposes is prohibited without the written consent of ADAC e.V. and Opel Automobile GmbH.

ADAC e.V., Opel Automobile GmbH and persons or companies authorised by both are entitled to use all logos and stickers of the sponsors of the driver or the competitor, all pictures and representations of the participating vehicles, the driver's and competitor's name, as well as all pictures and representations of the driver, the competitor and their equipment (this also applies to the team and driver's clothing) for the production of games about the series, for the marketing of the series or individual elements.

In particular, no advertising may be placed in or on the vehicle in the recording area of the on-board camera. Participants are not allowed to place advertising boards (on-board signs) with private sponsors in the vehicle. The official ADAC Opel e-Rally Cup logo may not be used by third parties (including participants) in any way in video publications without the prior consent of ADAC e.V. and Opel Automobile GmbH. The following participant-specific information may be included in video publications (incl. on-board recordings):

- Competitor name
- Names of driver and co-driver

The mentioned information may be inserted graphically. However, the insertions must not have an official character.

Participants are not allowed to contract companies that are in competition with ADAC e.V. or Opel Automobile GmbH as sponsors.

Participants registered in the ADAC Opel e-Rally Cup 2022 will be granted the rights to use any TV material for trade fairs and internal purposes upon a request submitted to the ADAC, without paying any fees for the rights of use and subject to assuming the technical costs. Any use of rights by sponsors, advertisers or for any other type of commercial exploitation must be requested in writing from ADAC and may be subject to a fee for the rights of use.

During all official events which are a qualifying round of the ADAC Opel e-Rally Cup 2021 (recce, test and set-up sessions and special stages), image and sound recording devices (e.g. TV cameras, digicams, etc.) may only be installed in the competition vehicles with the approval of the ADAC. These must moreover be approved by the scrutineers at the technical checks.

Excluded from this are cameras for eventual television material, which may be installed on the vehicles in agreement between the ADAC or Opel Automobile GmbH and the scrutineer. This image material shall be only available to ADAC and Opel Automobile GmbH.

The reproduction and use of the ADAC logo as well as of the official ADAC Opel e-Rally Cup logo is forbidden for all competitors, teams, drivers and all persons who are in contact with them. The use of ADAC-registered names or titles, with the exception of the title "ADAC Opel e-Rally Cup", is also prohibited.

The use of the title "ADAC Opel e-Rally Cup" is only permitted after prior approval by ADAC and Opel Automobile GmbH. Furthermore, as a matter of principle, the full title "ADAC Opel e-Rally

Cup" must be stated at all times on all materials produced by competitors, teams, drivers, co-drivers and all associated persons. Furthermore, only the ADAC Opel e-Rally Cup logo approved by ADAC e.V. may be used.

17. Specific Regulations

17. 1 E-Safety Training

The following training courses according to Appendix P to the ISC of the FIA Appendices 3 and 4 are mandatory as follows:

BASIC for marshals, scrutineers, heads of track safety and rally managers. ADVANCED for Technical Commissioners and the DMSB E-Relay.

A driver training course for teams.

Furthermore, the series organiser, the DMSB as well as the organisers use a one-pager in the programme booklet as well as a video publication to point out the dangers of EV and HEV.

Part 2: Technical Regulations

1. Technical Regulations of the Series

1.1 Summary of Groups/Classes

All vehicles in the ADAC Opel e-Rally Cup 2023 must comply with the technical specifications of these regulations.

Eligible vehicles and class division

OPEL CORSA-e RALLY

1.2 The Technical Regulations are based on

- Art. 253 of Appendix J (FIA ISC)
- Technical Regulations of the ADAC Opel e-Rally Cup
- General Regulations, Definitions and Clarifications of Technical Regulations (DMSB Yearbook, blue part)
- The present Technical Regulations
- Tyre regulations according to Appendix IV of the DMSB Rally Regulations 2023
- DMSB approved Technical Bulletins issued by ADAC e.V. and Opel Motorsport
- Service Guidelines (Vehicle Documentation) and current spare parts catalogue of the ADAC Opel e-Rally Cup 2023

1.3 General / Preamble

The ADAC appoints a permanent scrutineer for the ADAC Opel e-Rally Cup 2023. Anything not expressly permitted by these regulations, the FIA Appendix J, the DMSB-approved Bulletins issued by the ADAC, the DMSB General Regulations, the motor vehicle passport (KFP) as well as the Service Guidelines and spare parts catalogue of the ADAC Opel e-Rally Cup is prohibited.

Permitted work or modifications must not result in any unauthorised modifications or infringements of the regulations. The participant is responsible for ensuring that his vehicle complies with the Technical Regulations at all times.

Sealing:

The opening of the mandatory seals on the drive unit, HV battery and control unit may only be carried out by the scrutineer, by persons authorised by the scrutineer or with the scrutineer's express written permission. Likewise, the procedure after the opening of the seal, the work then permitted on the vehicle and the procedure for resealing must be clearly specified by the scrutineer.

It is the participant's responsibility to demonstrate that the removal of a seal is authorised and to follow the correct procedure after its removal up to the resealing, i.e. the participant must be able to demonstrate beyond doubt that the scrutineer has authorised the opening of the seal and all other procedures.

1.4 Driver and Co-driver Equipment

The wearing of overalls according to the current FIA Standard as well as underwear (with long sleeves and legs), balaclava, socks, shoes and gloves according to the current FIA regulations is mandatory.

Patches on overalls according to FIA Standard 8856-2000 (Bull. 384); when applying patches (e.g. advertising patches) to overalls of FIA Standard 8856-2000, the following must be observed:

- The fastening material or thread (e.g. Nomex thread) connecting the patch to the FIA homologated overall must be flame-retardant. (see detailed requirements and instructions in Appendix 1 of FIA Standard 8856-2000 or 8856-2018).
- The complete bottom layer of the patch backing material, i.e. the area in contact with the outer layer of the overall, must also be made of flame-retardant material, e.g. Nomex, and comply with ISO standard 15025. Furthermore, it is recommended that the other components of the patch are also made of flame-retardant material.

DMSB Note:

The text that the sewing thread of patches may only go through the outer layer has been deleted. This means that it is now also permitted to attach the patches through all existing layers of the coverall, using flame-retardant thread.

Until now, this was only allowed to be realised through the outer layer of the overalls. The above only applies to patches. The regulation that embroidered lettering or signs may only be attached to the outer layer of the overalls remains.

Furthermore, the helmet must be in accordance with the FIA regulations (Appendix L of the ISC).

In addition, the use of the FIA head restraint system (e.g. HANS®) is mandatory.

1.5 General Provisions, Permitted Modifications and Installations

Only work that is part of the normal maintenance of the vehicle or serves to replace parts that have become defective due to wear or accident may be carried out.

Modifications and installations may only be carried out within the framework specified below. Parts damaged through wear or accident may only be replaced with identical original parts.

On the complete vehicle, the standard fastening parts, such as: nuts, screws, washers, spring washers, spring plates, split pins, may be replaced by equivalent standard parts that correspond to the original shape. For threads, the thread type, size and pitch (e.g. M 8 x 1.25) must be retained.

1.6 Vehicle Minimum Weight and Ballast

(weight value, determination, reference scale if necessary, fixation of ballast)

At any time during the event, the minimum weight of the vehicle must be 1700 kg including driver and co-driver with their equipment (e.g. helmets, HANS systems, headsets, overalls etc.). This is the real weight of the vehicle with occupants and without draining or refilling liquids.

Should the installation of additional weights be necessary to achieve the minimum weight, this is only permitted in compliance with the procedure described in the Service Catalogue.

The installation of additional weights must be approved by the scrutineer at scrutineering before the start of the respective event.

If a vehicle loses a part prescribed in the regulations during the competition, the weight of this part may be taken into account at the weighing. After consultation with the permanent scrutineer,

it is at the discretion of the Stewards whether and which lost part will be taken into account for the weighing.

Drivers and co-drivers in racing condition (incl. helmets, overalls, headsets and Hans systems) will be weighed by the scrutineer on the day of the event during a time window individually defined for each event.

DMSB note: The DMSB Guidelines for the weighing of vehicles (incl. calibration of scales) must be observed by the organiser/series organiser. Mobile scales must hence be checked, normally by the scale manufacturer, at annual intervals. In exceptional cases, calibration/verification by a State Metrology Service is also permissible, but the scales must be calibrated by the manufacturer at least every 2 years.

1.7 Noise Regulations

The current DMSB Noise Regulations (see DMSB Yearbook, blue part) must be observed.

A sound system is installed as standard in the OPEL CORSA-e Rally vehicle. Modification of the system and settings are not permitted without the approval of ADAC e.V. and Opel Automobile GmbH.

The system must not be switched off while driving during an event. On the special stages, the system must be switched to "loud" via the central switch on the control unit. On the road sections, the system must be switched to "silent". In case of a failure of the system, it must be confirmed by a scrutineer.

1.8 Advertising on the Driver's Equipment /the Competition Car and Start Numbers

The current FIA/DMSB regulations for advertising on the driver's equipment, on competition vehicles and start numbers must be observed (see DMSB Yearbook, blue part).

Derogations from the FIA/DMSB regulations are subject to a special approval issued by the DMSB.

With due regard of the FIA/DMSB regulations for starting numbers and advertising on vehicles, the following mandatory advertising on the competition vehicle is compulsory. (see also Attachment 1 of these regulations).

Design of the Cup Vehicles (See Attachment 1)

ADAC e.V. and Opel Automobile GmbH have the right to apply their own design elements or the design elements of partners in the form of corresponding stickers to the surfaces of the vehicles. The mandatory design of the vehicles is shown in Attachment 1. The surfaces on which official sponsors are displayed must be single-coloured. The contrast of the sponsor logos to the colour of the background must be guaranteed.

The official sponsor areas must be observed as shown in Attachment 1. A minimum distance of 30 mm must be maintained between the official sponsor areas of ADAC e.V. as well as of Opel Automobile GmbH and the team's own sponsors. Areas that are not designated as official sponsor areas are may be used by the participants. The team's own sponsors may not be in competition with ADAC e.V. or Opel Automobile GmbH.

The vehicle design must comply with the above conditions during all ADAC Opel e-Rally Cup events, at official test runs/test events, at trade fairs and on photo and video materials.

Only the series stickers provided by the ADAC may be used. Before the season, each participant will receive two complete sets of series stickers. Any further requirements will be charged to the participants at cost price. The correct application of the series stickers will be checked at scrutineering.

The first letter of the first name and of the surnames of driver and co-driver, together with the respective national flag, must be displayed on the rear side windows in accordance with the following guidelines:

- White, Helvetica
- Initial letters in upper case, remaining letters in lower case
- Height 6 cm (for capital letters), line width: 1.0 cm

The driver's name must be the top name on both side windows.

The following special advertising regulations apply to the driver's equipment (see also Attachment 1):

ADAC and Opel Automobile GmbH have the right to have their own identification or the identification of series partners affixed to areas of the driver's equipment in the form of corresponding patches.

The official sponsor patches must be attached as shown in Attachment 1 and must not be altered in any way. Patches must be attached with a non-flammable thread (Nomex) (according to DMSB Yearbook, blue part).

The official sponsor areas must be observed as shown in Attachment 1. No sponsors of the participants may be applied in these areas. All other areas of the driver's overall may be used by the participants. A distance of 10 mm to the official sponsor area must in each case be maintained.

The correct attachment of the series sponsors will be checked at scrutineering.

1.9 Safety Equipment

The vehicles must be provided with the following safety equipment.

- Unless otherwise stated, the article numbers refer to the current Appendix J to the ISC.
- Lines and pumps according to Art. 253.3.1 and 253.3.2
- 2-circuit braking system according to Art. 253.4
- Bonnet safety fastener according to Art. 253.5
- Safety belts according to Art. 253.6
- Manual fire extinguisher according to Art. 253.7.3
- Fire extinguishing system according to Art. 253.7.2
- Safety cages according to Art. 253.8
- Rear-view mirrors according to Art. 253.9
- Towing eyes/devices according to Art. 253.10
- Safety foil on windows according to DMSB regulations and general type approval with marking (e.g. : D~5178)
- Laminated glass windscreen
- Circuit breaker according to art. 253.13
- Fire protection screen according to Art. 253.15
- Seats and supports according to Art. 253.16
- Prohibition of tyre pressure control valves according to Art. 253.17
- Special requirements for electrically-powered vehicles according to Art. 253.18
- Opel Corsa-e Rally safety displays (see Attachment 4)

Attention: For events abroad, it is the series organiser’s responsibility to observe and apply any deviating or additional safety regulations of the respective ASN.

For the ADAC Opel e-Rally Cup vehicle, a current rescue data sheet is stored under the link <https://www.ifz-berlin.de/#/rescue>. The vehicle must comply with the descriptions in this rescue data sheet.

1.10 Recharging the HV Battery

1.10.1 Location

During the event, any charging may only be carried out by the competitors in the charging zones specified by the organiser in the Road Book and in the Supplementary Regulations or in the service park. Each charging zone established on site is binding for all participants and will be announced via team info before the respective event. Any charging may only take place in the defined charging zones. A vehicle may be pushed out of the zone by the team, officials and/or the two drivers.

1.10.2 Charging Procedure

Activities that are not directly related to the work on the HV system are permitted during the loading process. A speed limit of 5 km/h is enforced in all charging zones. It is recommended for mechanics to wear fireproof clothing.

The duration of the charging process may be limited in time by the organiser via bulletin.

The condition of the vehicle is indicated in the service park via roof number carriers which are provided by the organiser. The condition of the vehicle / HV system is hereby to be marked as follows:



High voltage system switched off, checked and secured against being reconnected	Vehicle switched off, high voltage system active	System error high-voltage system Examination by qualified personnel necessary
Service work on the vehicle possible	Service work on the vehicle possible	Service work on the vehicle NOT possible
Service work on the HV system possible for qualified personnel	Service work on the HV system NOT possible	Service work on the HV system NOT possible
Charging NOT possible	Charging possible	Charging NOT possible

1.11 Technical Definitions

In addition to the definitions according to these regulations, the "General Provisions, Definitions and Clarifications of Technical Regulations" (DMSB Yearbook, blue part) as well as the definitions according to Art. 251 of Appendix J (ISC) apply.

2. Special Technical Regulations

2.1 General

In addition to the Technical Regulations in Part 2 of these regulations, the following Special Technical Regulations also apply.

Anything not expressly permitted by these regulations, the FIA Appendix J to the ISC, the DMSB-approved ADAC Technical Bulletins, the DMSB General Regulations, the motor vehicle passport (KFP) as well as the Service Guidelines and Spare Parts Catalogue of the ADAC Opel e-Rally Cup is prohibited.

Permitted work or modifications must not result in any unauthorised modifications or infringements of the regulations.

In the case of modifications applied to series components, the previous parts that are no longer available remain permitted unless a different procedure is clearly indicated in a bulletin.

If standard parts are no longer available and the participant therefore uses parts that are not expressly approved by the Spare Parts Catalogue or by these regulations, it is the participant's responsibility to inform the permanent scrutineer of this before an event.

The scrutineer will then decide on the admissibility of the component and may request the participant to provide appropriate evidence of this, e.g. by means of a printout of the Opel Spare Parts Catalogue (EPC).

2.2 Drive Unit

The drive unit and the associated control unit must comply with the Cup specific drive throughout the entire event.

Each Cup specific drive and the associated control unit are sealed and the seals must be undamaged, visible and clearly legible throughout the event.

Before each event, the seal will be checked by the scrutineer responsible for the Cup. A vehicle without a correct seal will not be admitted to the event.

Any modification to the Cup specific drive and to the associated control unit, in particular to its programming, will result in immediate disqualification.

The participant is responsible for the correct sealing and the condition of the seals during the event.

A seal will be attached to the plug of the control unit. If it is necessary to open the seal in order to replace damaged components, the scrutineer responsible for the Cup must be informed in advance. The procedures and conditions specified in the Technical Regulations point 1.3 in the paragraph "Sealing" must be exactly observed.

2.3 HV Battery

Each HV battery is sealed and allocated to the corresponding vehicle. The two housing parts of the HV battery are glued in the factory and may not be opened neither during an event nor between the various events of the ADAC Opel e-Rally Cup. A vehicle with damaged bonding will not be admitted to the event. Any modification to the HV battery will result in the immediate disqualification.

The participant is responsible for the correct sealing of the HV battery during the event.

It is not possible to replace the HV battery during the event.

A replacement of the HV battery is only possible between the ADAC Opel e-Rally Cup events. For this purpose, a replacement HV battery can be obtained from Opel Motorsport. The replacement of the HV battery must be reported at the next technical scrutineering.

If the condition of the HV system (drive unit or HV battery) is unclear, the competitor must secure the vehicle in the service park against access from the outside by means of barrier tape and mark it in accordance with Attachment 5.

2.4 Brakes

Dual circuit brake system without ABS, see ADAC Opel e-Rally Cup Service Guidelines or Spare Parts Catalogue. Only the brake pads specified in the Spare Parts Catalogue are permitted.

When parking the vehicle, it is the driver's responsibility to always secure the vehicle against unintentional movements.

2.5 Steering

Steering Gear

Only the steering gear described in the Spare Parts Catalogue is permitted for the ADAC Opel e-Rally Cup vehicle.

Steering Wheel

Only the steering wheel described in the Spare Parts Catalogue is permitted for the ADAC Opel e-Rally Cup vehicle.

Steering Wheel Adapter

Only the steering wheel adapters described in the Spare Parts Catalogue are permitted.

2.6 Wheel Suspension

Chassis

Only the springs described in the Spare Parts Catalogue are permitted for the ADAC Opel e-Rally Cup vehicle and they must be installed in the specified positions. The use of spacers is not permitted. The rims specified in the Spare Parts Catalogue must be used.

Shock absorber

Only the non-adjustable shock absorbers described in the Spare Parts Catalogue are permitted for the ADAC Opel e-Rally Cup vehicle. No modifications of any kind may be applied to the shock absorbers. A change of the characteristic curves is not permitted.

Stabiliser

Only the standard stabiliser described in the Spare Parts Catalogue is permitted for the ADAC Opel e-Rally Cup vehicle: The stabiliser must be bolted in place in accordance with the Service Guidelines and the Spare Parts Catalogue at all times during the event.

2.7 Wheels (disc + rim) and Tyres

Only the single rims described in the Spare Parts Catalogue are permitted for the ADAC Opel e-Rally Cup vehicle.

Tyre manufacturer: Michelin
Tyres: Tread depth of the tyres mounted on the vehicle min. 1.6 mm at each time during the event
Tyre size: 19/63-17
Type: Slick tyre R21 and rain tyre MW1

2.7.1 Limitation of Tyres

In accordance with the current rally regulations, each participant may nominate a maximum of 6 slick tyres of type R21 as well as 6 rain tyres of type MW1, uniformly cut, per event. The maximum number of 6 slick tyres of type R 21 as well as 6 rain tyres of type MW1 may not be exceeded. The tyres permitted in the ADAC Opel e-Rally Cup may only be obtained from the tyre provider nominated for the Cup.

A maximum of 6 new tyres of the following tyre specifications may be nominated as joker tyres during the current season: R21 slick tyres, MW1 rain tyres.

Joker tyres may also be nominated during an event (subject to complying with the maximum number permitted).

Any modification of the tyres by chemical treatment is prohibited. Furthermore, it is prohibited to cover the tyres by using heating blankets or anything similar that may affect the grip and consistency of the tyres. Regrooving is not permitted.

A mixed use of slick and rain tyres (e.g. slick tyres on the front axle and rain tyres on the rear axle) is permitted.

The tyres will normally be marked by the scrutineer after scrutineering in a time window individually defined for each event. The respective time window will be announced before each event in an official team information. Participants are obliged to present their tyres chosen for the respective event during this time window for the purpose of having them marked.

2.8 Bodywork and Dimensions

a) Exterior (incl. windows)

Only the bodyworks manufactured and prepared for the ADAC Opel e-Rally Cup may be used. The bodyworks are equipped with a welded-in safety cell (FFSA certificate number 510) with the corresponding three-digit serial number which may not be modified.

The body dimensions of the ADAC Opel e-Rally Cup vehicle are as follows:

Length: 4,060 mm +/- 1% tolerance
Width: 1,770 mm +/- 1% tolerance incl. folded-out exterior mirrors

These dimensions must not be changed.

The ground clearance on the front axle is determined by the distance between the spring plate and the stabiliser mount and must be at least 70 mm (see Attachment 2). The measuring point on the front axle is the lowest point between the underride guard and the road surface. The measuring point on the rear axle is the lowest point between the underbody protection and the

road surface. The measurement is taken with the vehicle in running order, including driver and co-driver.

The fitting of a plastic cover between the front bumper and the front edge of the underride guard is optional.

b) Cockpit

Seats

Only the FIA homologated seats described in the Spare Parts Catalogue are permitted for the ADAC Opel e-Rally Cup vehicle.

Safety belts

Only the seat belts described in the Spare Parts Catalogue are permitted for the ADAC Opel e-Rally Cup vehicle.

The fitting of belt pads is permitted. The shoulder belts must run crosswise between the seat and the belt mounting eyes. In the case of a vehicle involved in an accident, the seat belts must be replaced. The scrutineer is authorised to mark belts as defective after an accident. The original mounting points as described in the ADAC Opel e-Rally Cup Service Guidelines or Spare Parts Catalogue must be maintained.

Fire extinguishing system

Only the FIA homologated electrically controlled extinguishing system described in the Spare Parts Catalogue is permitted for the ADAC Opel e-Rally Cup vehicle.

Manufacturer:	Lifeline
Type:	Zero 360 - 3.0 kg Electric
FIA Homologation No:	EX. 042.17

c) Additional accessories

See Spare Parts Catalogue.

2.9 Electrical Equipment

See Spare Parts Catalogue.

2.10 Data Transmission

For control purposes, ADAC e.V. or Opel Automobile GmbH may at any time install an independent data logger in one or more competition vehicles. Any interference with the data logger is prohibited. The interfaces to the vehicle wire loom must be connected at all times.

The data recorder is sealed by the scrutineer and data may only be downloaded by ADAC e.V. or Opel Automobile GmbH.

2.11 Lights/Additional Headlamps

Only auxiliary lights according to the Spare Parts Catalogue are permitted. Participants are free to drive with or without auxiliary lights.

2.12 Miscellaneous

Not applicable.

Part 3 Attachments/Drawings

Attachment 1 Sticker instructions vehicles /sponsor areas driver/co-driver overalls

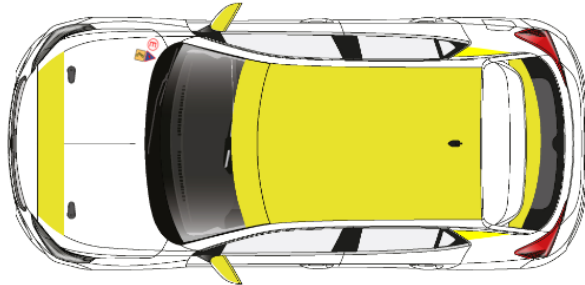





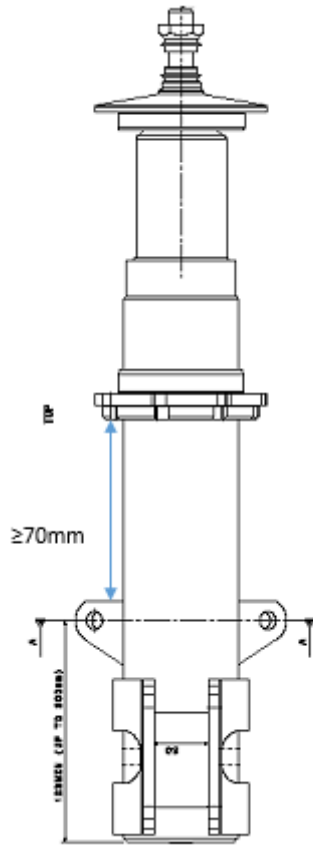

The areas marked yellow are reserved for obligatory advertising.

Attachment 2 Suspension adjustment front axle



Attachment 3 Safety Displays

The vehicle for the ADAC Opel e-Rally Cup is equipped with safety displays monitoring the high-voltage system as standard. The system is battery-powered and operates independently of the vehicle's electrical system. It is the responsibility of the competitor to ensure the proper charging of the batteries. The driver must ensure that the system is working before departing and he can check the function of the emergency indicator using the test button in the centre console.

Safety display	Description	Status
	Green lamps: High-voltage system is safe and works as expected	VEHICLE IS SAFE Special safety precautions are not necessary
	Orange lamps: Accelerator pedal is activated, Vehicle ready for departure	VEHICLE IS READY TO START Vehicle is ready to start or travels at less than 6 km/h
	Lamps off: 1. Vehicles drives or 2. Vehicle is switched off (e.g. is parked) or 3. Problem with safety displays	VEHICLE IS DRIVING Vehicle travels at more than 6 km/h VEHICLE SWITCHED OFF Accelerator pedal / high-voltage system is deactivated, vehicle not ready to start POSSIBLE SYSTEM ERROR Special safety precautions are necessary 
	Red lamps flash + audible signal: Electrical resistance deviates from target specification	SYSTEM ERROR Special safety precautions are necessary 

Notwithstanding ISC Appendix J, Art 253, 22.18, the "ready-to-move" condition (vehicle ready to start) will be indicated at the front with an orange instead of a white lamp in the ADAC Opel e-Rally Cup.