

Réf. : 2835.00.0

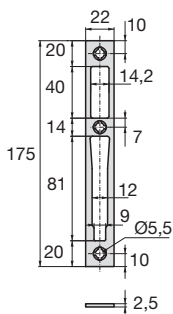

Réf. : 2835.24.0

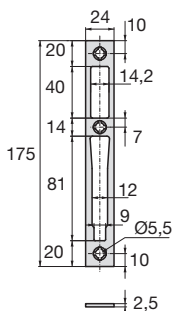

Réf. : 2835.00.1

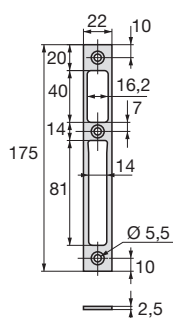

Réf. : 2834.52.0

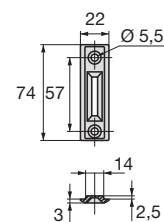

Réf. : 2835.00.1U6

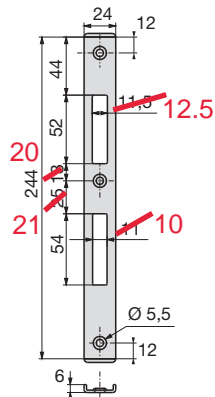

Réf. : 2835.20.0

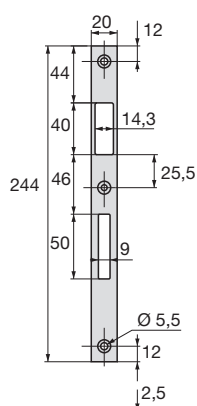

Réf. : 2835.00.0U6

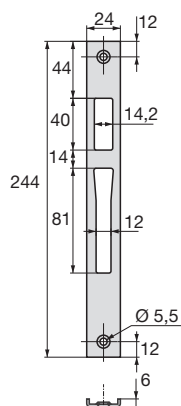

Réf. : 2835.00.0U6V2

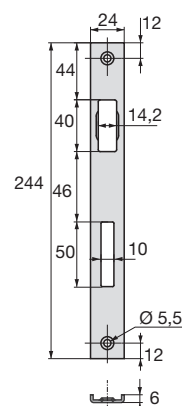

Réf. : 2835.00.xA2P

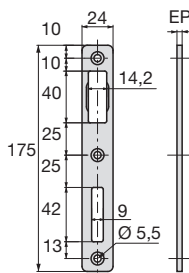

Réf. : 2839.xx.x

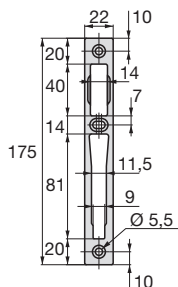

Réf. : 2839.xx.xL19

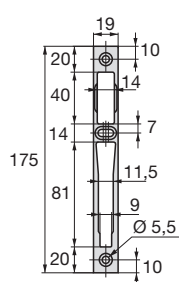

Réf. : 2839.xx.xL24

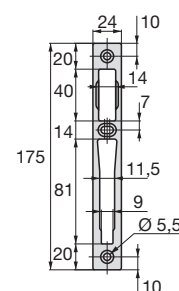

Ep.	Acier
4	2835.00.1A2P
6	2835.00.2A2P
8	2835.00.3A2P
10	2835.00.4A2P
12	2835.00.5A2P

Ép. /	Alu AS	Alu noir /
4	2839.10.1	2839.17.1
6	2839.10.2	2839.17.2
8	2839.10.3	2839.17.3
10	2839.10.4	2839.17.4
12	2839.10.5	2839.17.5

Ép. /	Alu AS	Alu noir /
6	2839.10.2L19	
10	2839.10.4L19	2839.17.4L19

Ép. /	Alu AS	Alu noir /
4	2839.10.1L24	2839.17.1L24
6	2839.10.2L24	2839.17.2L24
8	2839.10.3L24	2839.17.3L24
10	2839.10.4L24	2839.17.4L24

Gâches centrales réglables

Réf. : 2835.22.0R

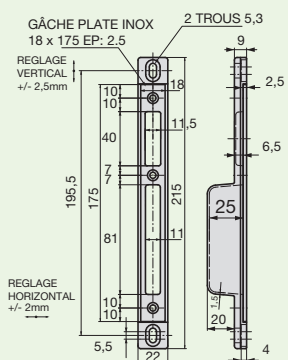

Réf. : 2835.00.U6RG

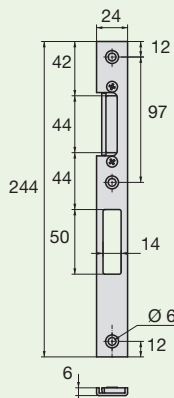

Réf. : 2835.00.0U6RD

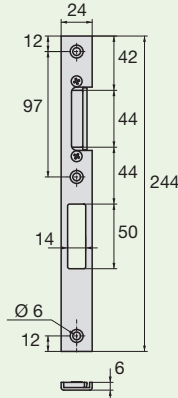

Réf. : 2835.24.0R

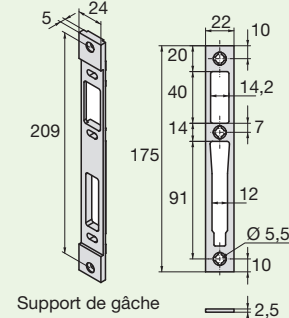

Pour serrure pènes A et D

Réf. : 2840.xx.2L20

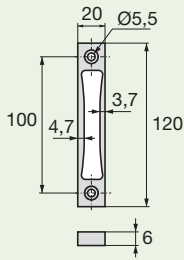

Réf. : 2840.00.0L22

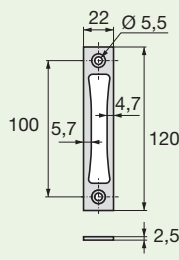

Réf. : 2840.00.0

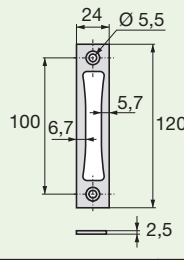

Ép. /	Alu AS	Alu noir /
6	2840.10.2L20	2840.17.2L20

Ép. /	Alu AS	Alu noir /
4	2840.10.1	2840.17.1
6	2840.10.2	2840.17.2
8	2840.10.3	2840.17.3
10	2840.10.4	2840.17.4

Pour serrure pènes i séries 6270 et 6470i

Réf. : 2843.00.0

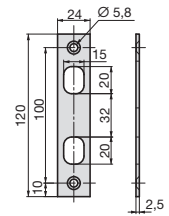

Pour serrure pènes B

For locks bolts B

Réf. : 2840.00.2B

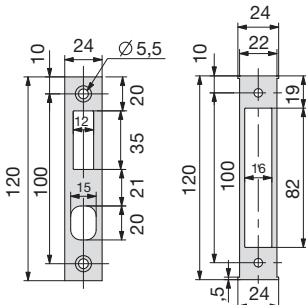

Réhausse. ép: 5 mm

Réf. : 2840.00.3B

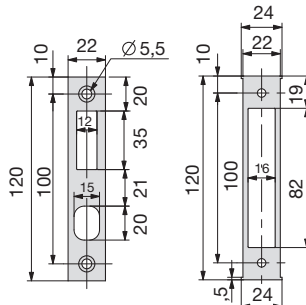

Réhausse. ép: 5 mm

Réf. : 2840.00.xA2P

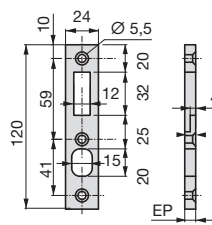

Ep.	Acier
4	2840.00.1A2P
6	2840.00.2A2P
8	2840.00.3A2P
10	2840.00.4A2P
12	2840.00.5A2P

Pour serrure pènes C

Réf. : 2840.00.1

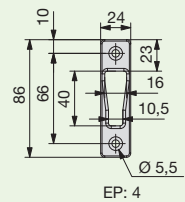

Gâches réglables pour serrure pènes B

Adjustable strikes for locks bolts B

Réf. : 2840.22.0R

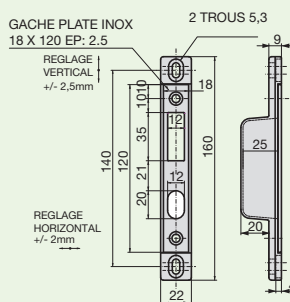

Réf. : 2840.24.0RB

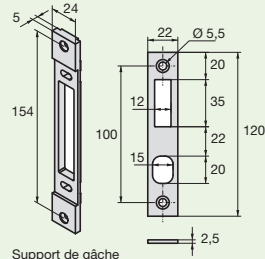

Support de gâche

Gâche réglable pour serrure pènes A ou D

Réf. : 2840.24.0RD

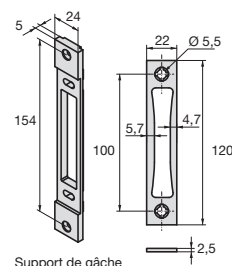

Support de gâche

Gâches haute et basse

Réf. : 2834.00.0

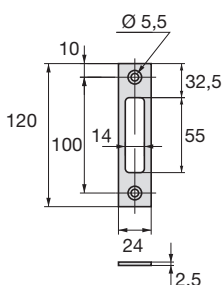

Réf. : 2834.10.4
2834.17.4

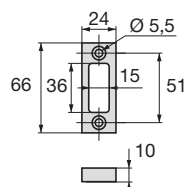

Réf. : 9954.31.0

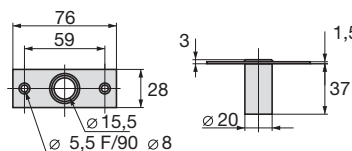

Réf. : 9954.31.3

