





MODE D'EMPLOI**INSTALLATION INSTRUCTIONS****BEDIENUNGSANLEITUNG****BOUTON POUSSOIR en ABS****PUSH BUTTON made of ABS****TÜRÖFFNERTASTER ABS -Ausführung**

ST_PBNONC_A_150717

PBNONC

				
Sans boîtier de mise en applique Without surface mounting box Ohne aP- Montage Gehäuse 86 x 86 x 14 mm	 3 A	 -5 + 55° C	 0,65 kg	 20
Avec boîtier de mise en applique With surface mounting box Mit aP- Montage Gehäuse 86 x 86 x 46 mm	36V DC max.			

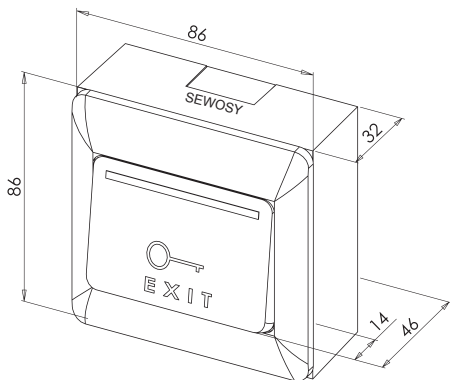

Raccordement
 Connection
 Anschluss

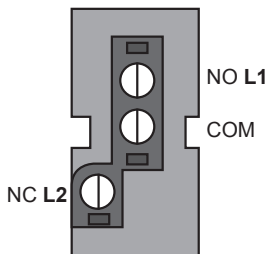

Sous réserve de modifications techniques - Technical changes reserved!
 Änderungen vorbehalten!



13b rue Saint-Exupéry ZA Aérodrome F-67500 HAGUENAU ☎ 33 (0)3 90 59 02 20 📠 33 (0)3 90 59 02 19

www.sewosy.eu

Montage - Mounting

Accès au système de fixation du bouton - Access to button's fastening system
Zugang an das Türöffnertasterbefestigungssystem

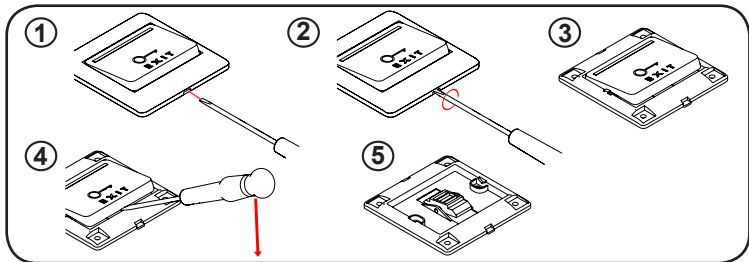

Pose encastrée - Mortise mounting - uP- Montage

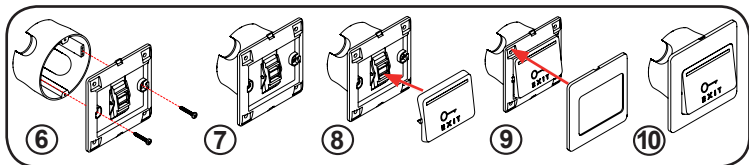

Pose en applique - Surface mounting - aP- Montage

Si passage de câble par le haut - If cable opening from the top
Falls Kabelführung durch Oberteil

