

NOTICE DE MONTAGE

HRS33215X

■ Découpe/ montage

1- Monter le profil Ventouse sur le dormant

⇒ Utilisez des vis M5 ou M6, têtes rondes, selon le support. Intervalle conseillé 200 mm

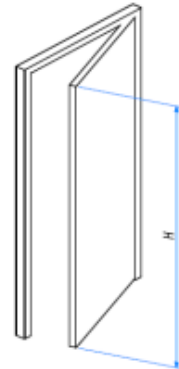
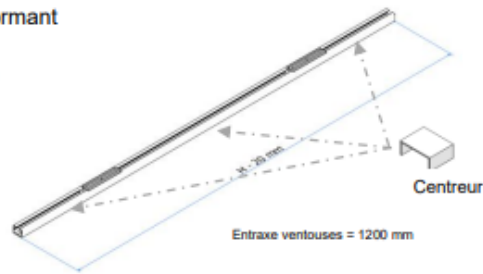
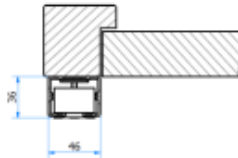

2- Monter le profil support sur l'ouvrant

⇒ Utilisez des vis M5 ou M6, têtes rondes, selon le support. Intervalle conseillé 200 mm
⇒ Centrer la découpe sur la ventouse comme sur la Fig. A

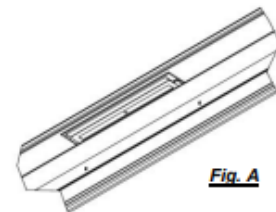
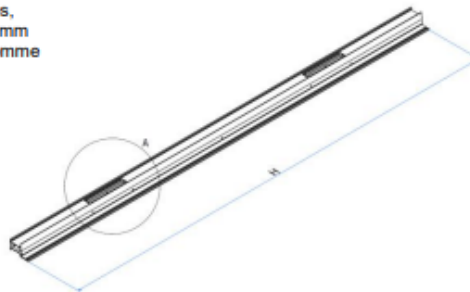
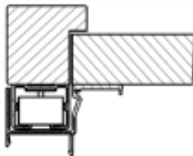

3- Clipper le profil poignée sur le profil support

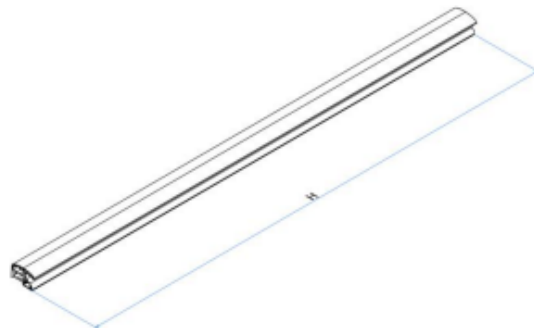
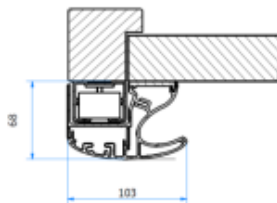

4- Finaliser l'assemblage du profil poignée à l'aide des 7 Vis 3.5 x13 fournies

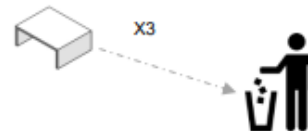
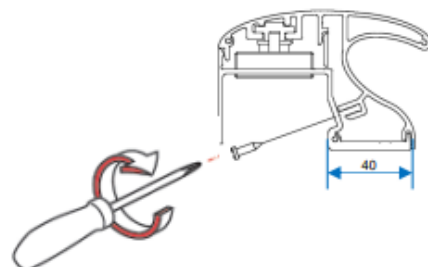

0 810 01 60 00 Service 0,06 € / min + prix appel

■ Raccordement

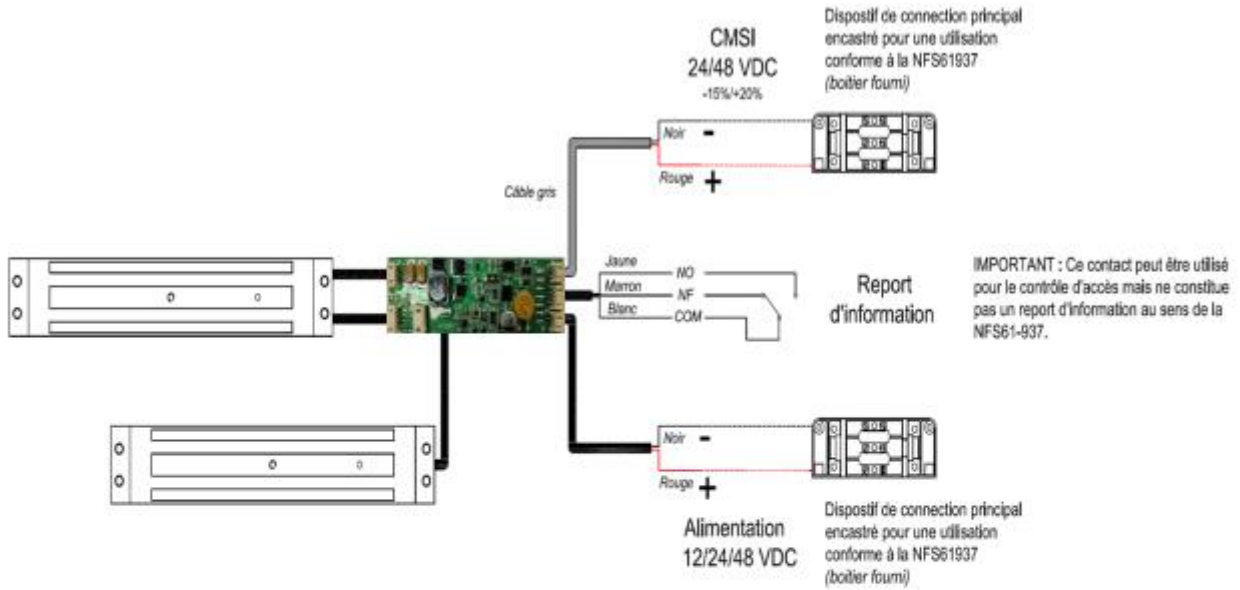

Interrupteur de fonction CMSI :

On: pas de CMSI: on branche que le câble alimentation
1 (CMD): CMSI: on branche le câble CMSI **ET** le câble alimentation

■ Finition

- Monter les embouts d'extrémité à l'aide des vis fournies
- Fermer le profil ventouse à l'aide du profil Capot  fourni et préalablement mis à longueur

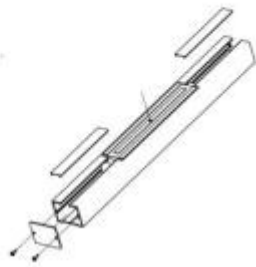

■ Accessoires en option : Renfort et poignée de tirage

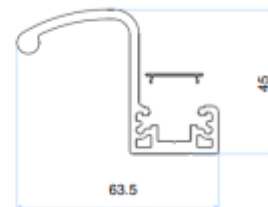
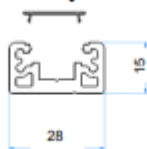

0 810 01 60 00 Service 0,06 € / min
+ prix appel

www.heracles.fr

At Forum du Bâtiment, 76 rue Nicolas Copernic Z.A.E Les Portes de l'Oise 60230 Chambly