

PEUGEOT



EnergySaw-254B3



Peugeot Outillage

132003-2-Manual-I-20220722

FR MANUEL D'UTILISATION (Notice originale) :
NL HANDBOEK (Vertaling van het oorspronkelijke):
ES MANUAL (Traducción del original):
PT MANUAL (Tradução do manual original):
IT MANUAL (Traduzione dell'avvertenza originale):
EN USING MANUAL (Original manual translation):

Scie de table et d'établi
Tabel Saw en werkbank
Sierra de mesa y banco de trabajo
Serra e bancada da tabela
Sega da tavolo e banco da lavoro
Table and Workbench saw

peugeot-outillage.com



FIG. A & B

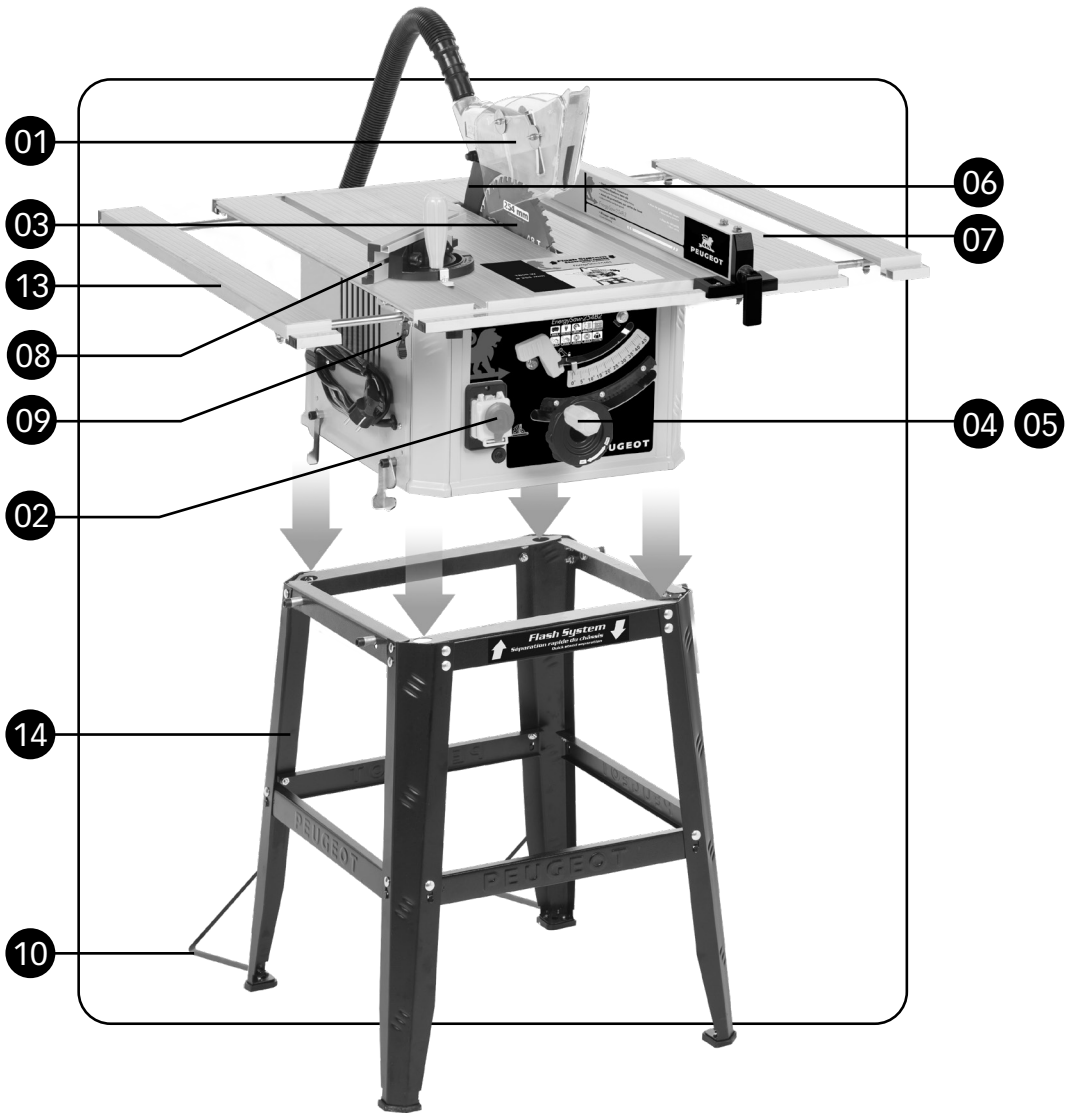

FIG. C

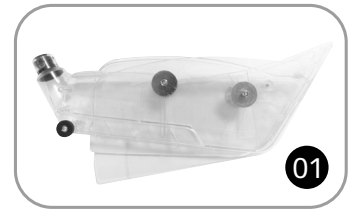
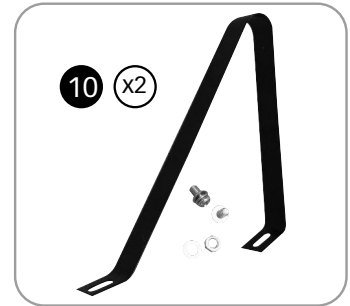
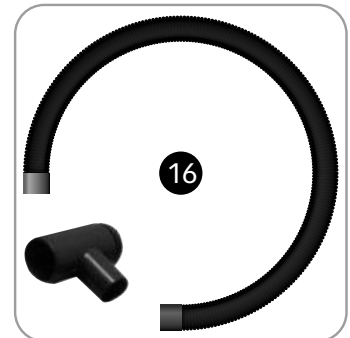
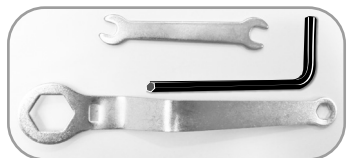
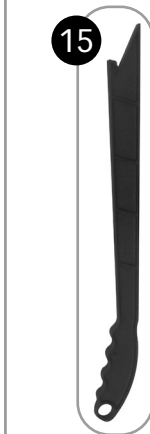
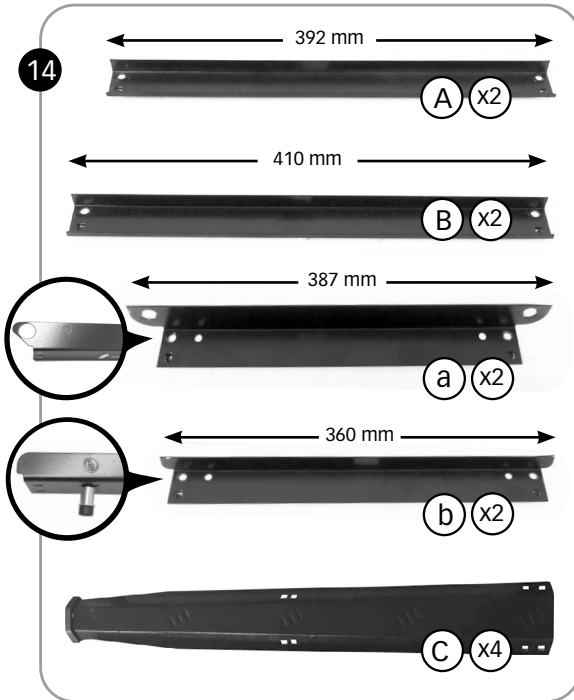
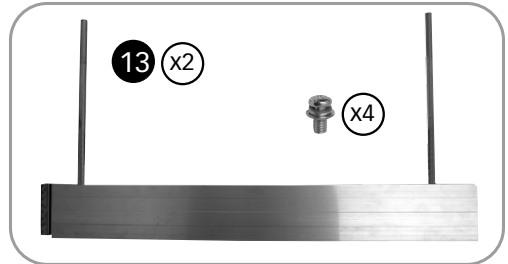
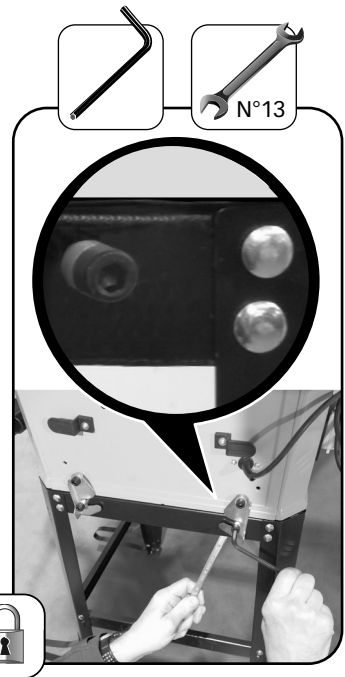
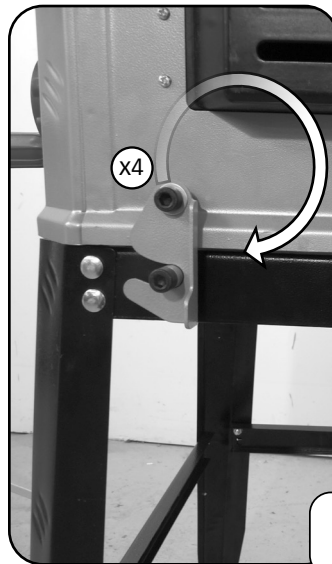
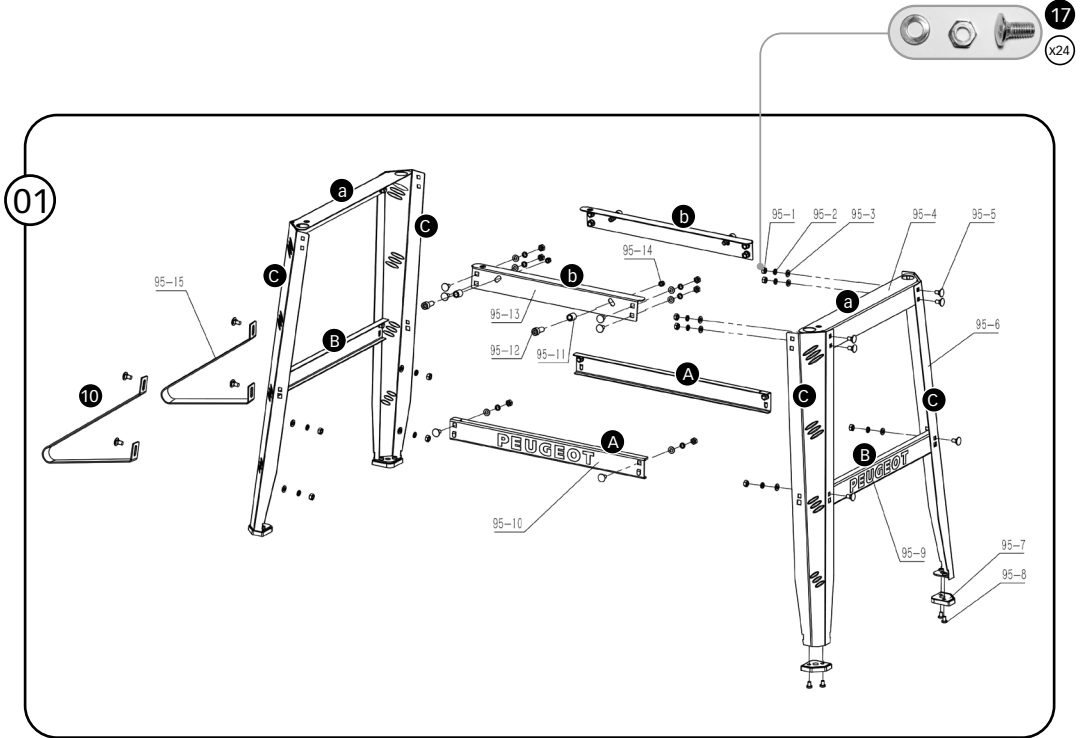

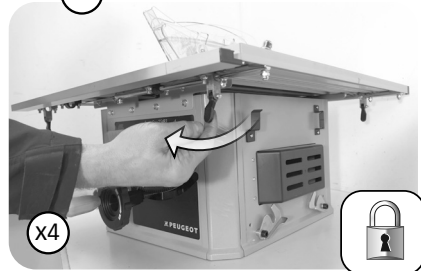
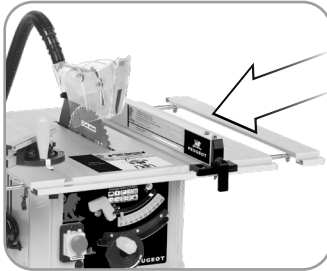
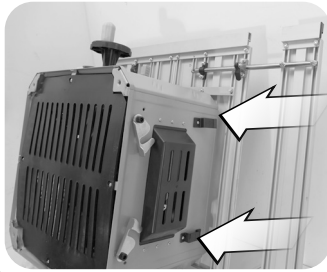
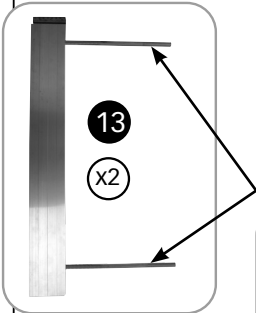

FIG. D





03



04

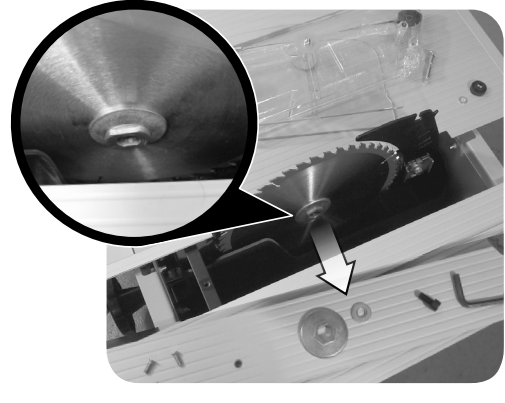
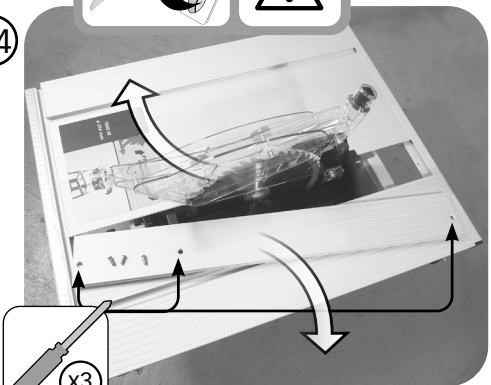
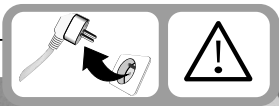

04

OPTION



801345

Lame 48 dents pastilles de carbure
Blade 48 tanden hardmetalen wisselplaten
Hoja de 48 dientes de carburo de insertos
Inserre lámina de 48 dientes de metal duro
48 T blade
Lama 48 denti

801346

Lame 60 dents pastilles de carbure
Blade 60 tanden hardmetalen wisselplaten
Hoja de 60 dientes de carburo de insertos
Inserre lámina de 60 dientes de metal duro
60 T blade
Lama 60 denti

801347

Lame 80 dents pastilles de carbure
Blade 80 tanden hardmetalen wisselplaten
Hoja de 80 dientes de carburo de insertos
Inserre lámina de 80 dientes de metal duro
80 T blade
Lama 80 denti

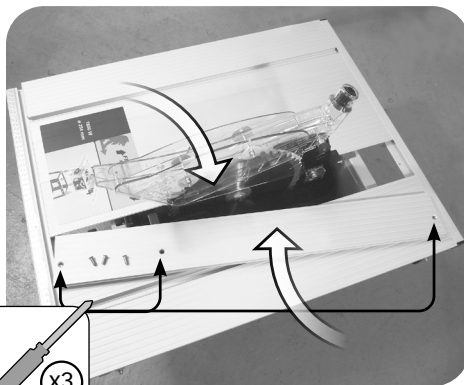
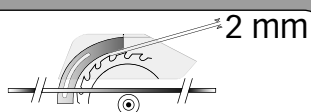
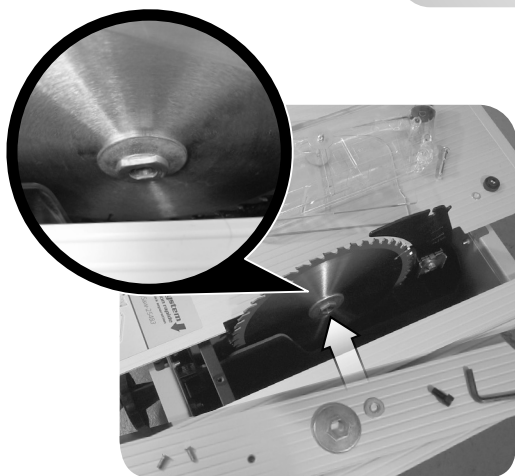

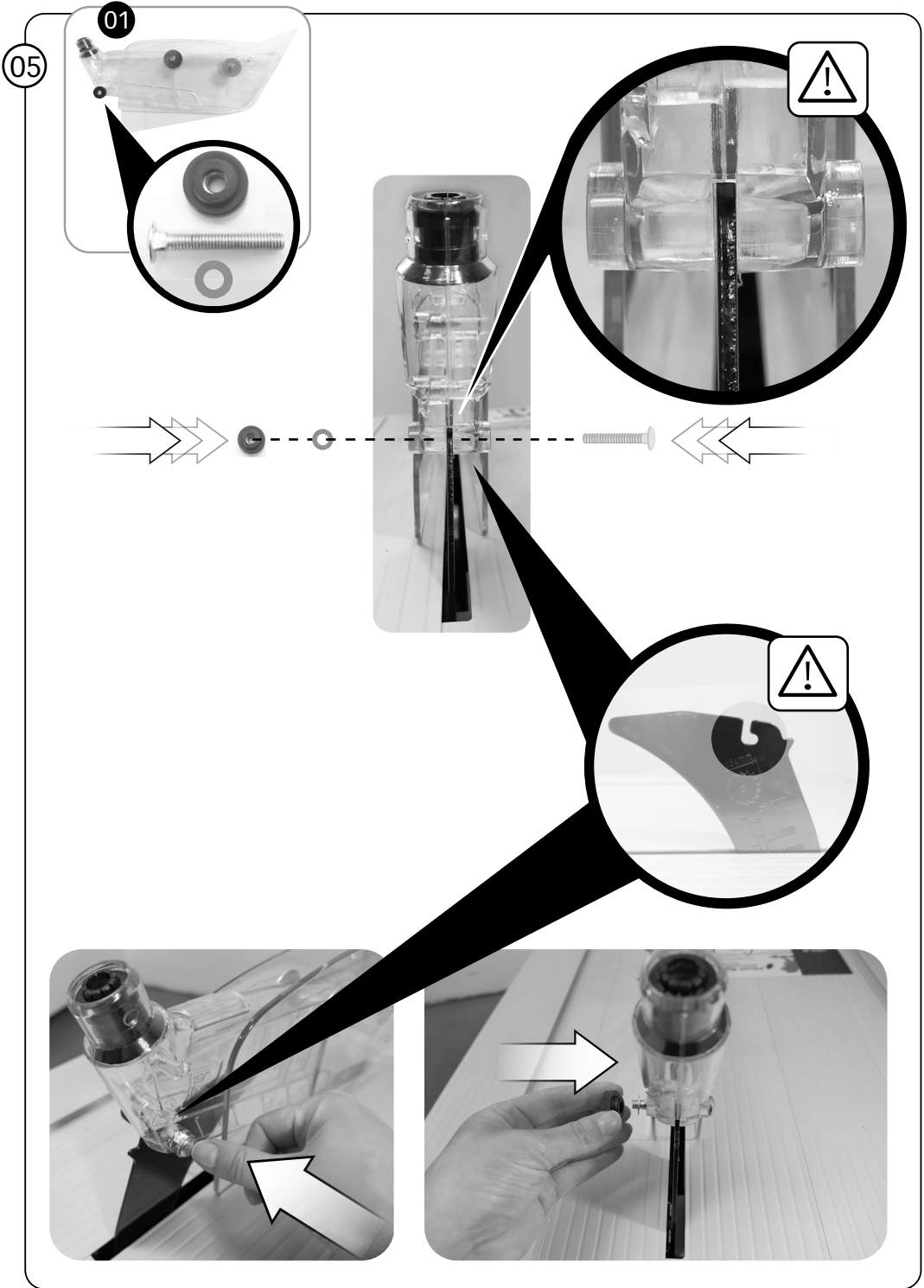

01

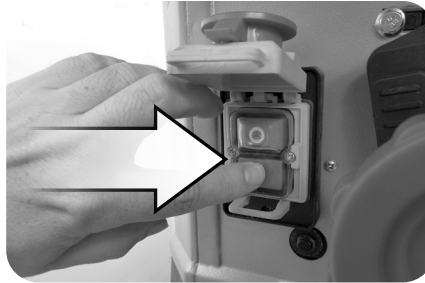

Protection thermique

Thermische beveiliging - La protección térmica - A proteção térmica - Protezione termica - Thermal protection

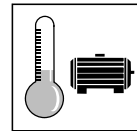
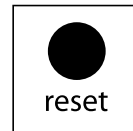
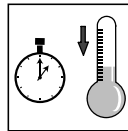
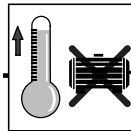
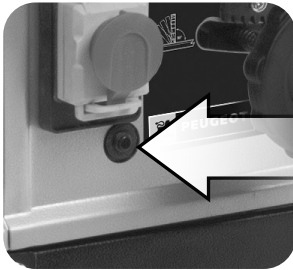

Cette machine est équipée d'une protection thermique.
En cas de surchauffe du moteur celui-ci s'arrête automatiquement.
Pour le redémarrer, il faut attendre qu'il puisse refroidir,
enclencher le bouton de réarmement et rallumer le moteur.

Deze machine is uitgerust met een thermische beveiliging.
Als de motor oververhit raakt zal het automatisch stoppen.
Om het opnieuw te beginnen, wacht het om te koelen,
schakelaar op de terugstellen knoop en draai de motor opnieuw.

Esta máquina está equipada con protección térmica.
Si el motor se sobrecalienta se detendrá automáticamente.
Para reiniciarla, espere a que se enfríe, encienda el botón de reinicio y encienda de nuevo el motor.

Esta máquina está equipada com protecção térmica. Se o motor pára automaticamente.
Para reiniciá-lo, aguarde que esfrie, ligue o botão de reset e ligue o motor novamente.

Questa macchina è dotata di protezione termica. Se il motore si surriscalda si ferma automaticamente.
Per riavviarla, attendere che si raffreddi, accendere il pulsante di reset e riaccendere il motore.

This machine is equipped with thermal protection. If the engine overheats it will stop automatically.
To restart it, wait for it to cool, switch on the reset button and turn the engine on again.

02

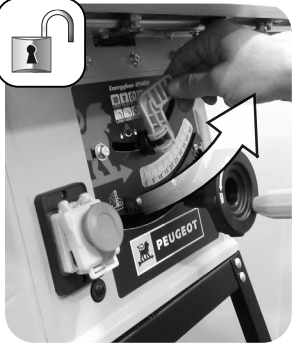

Ajustement réglage fin - Fijne instellingsaanpassing - Ajuste fino -
Ajuste de ajuste fino - Regolazione dell'impostazione fine - Fine setting adjustment

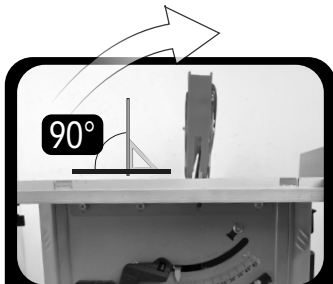

90°



N°10



45°

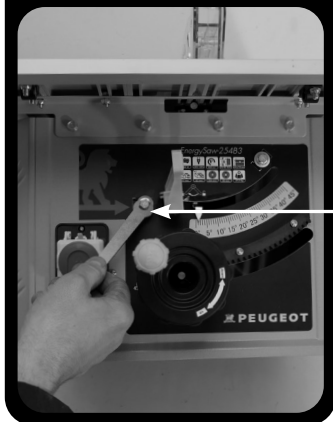



03

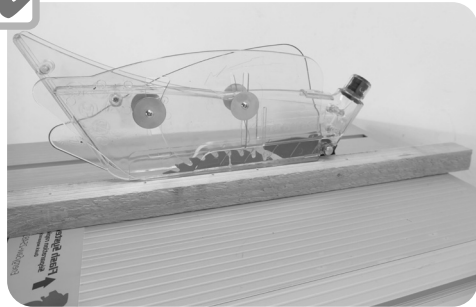
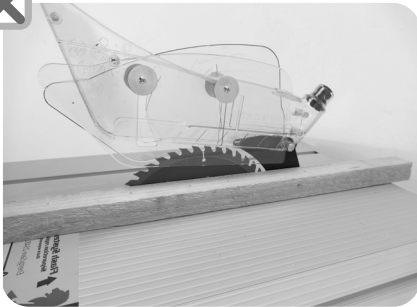
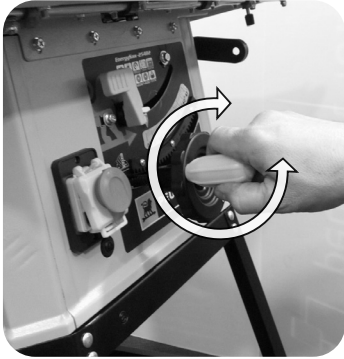

04

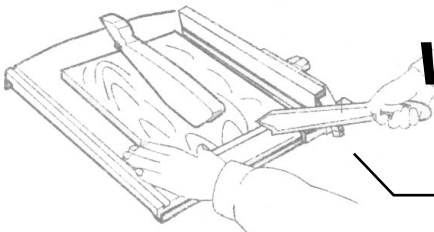
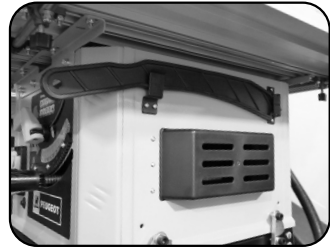
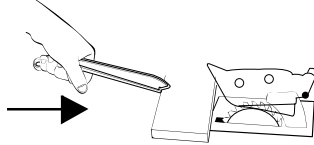

WARNING ! ATTENTION !



05

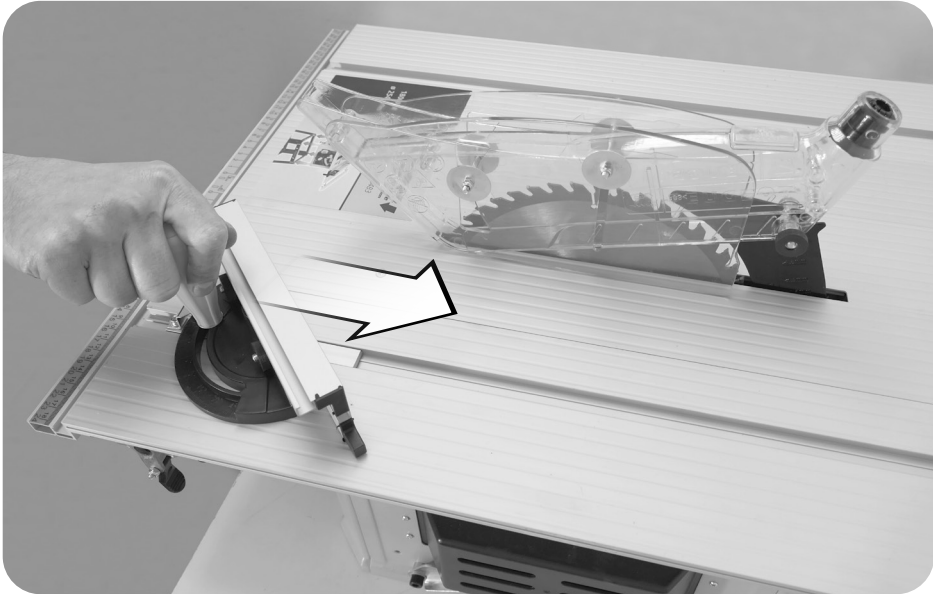
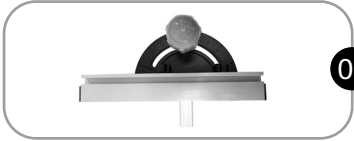



05

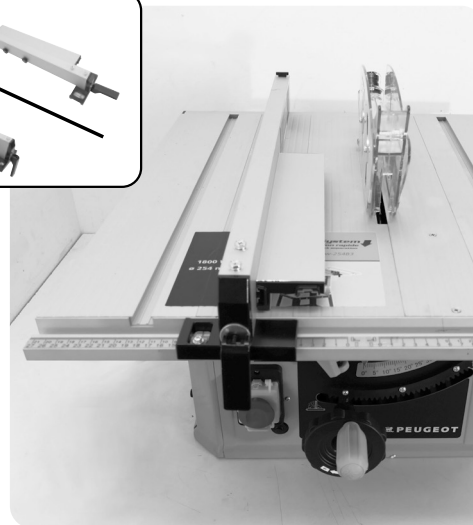
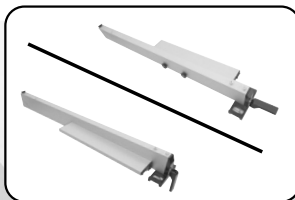
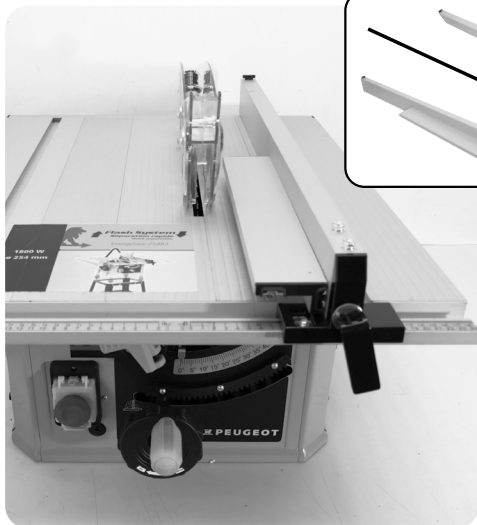
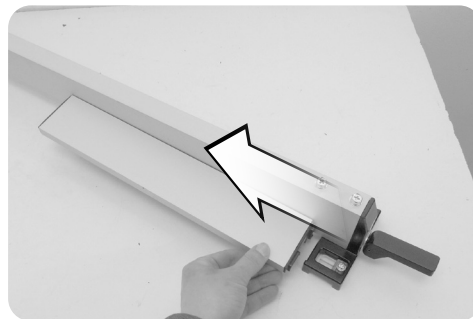
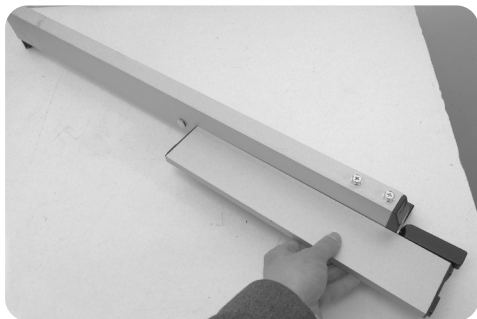
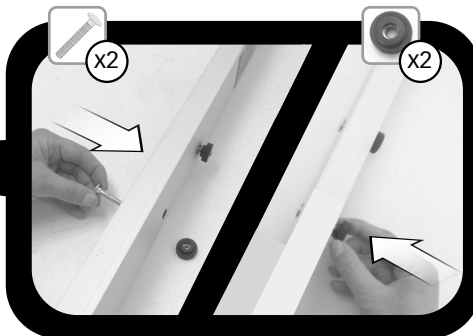
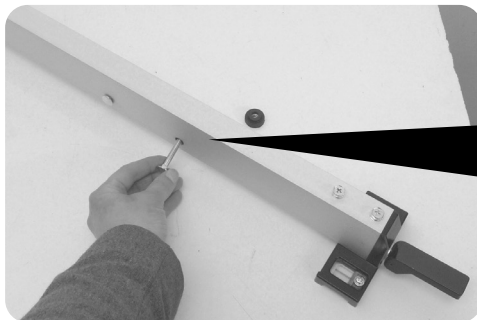
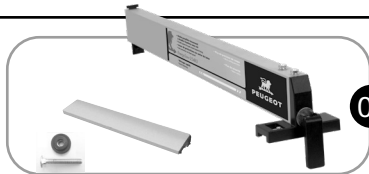



05

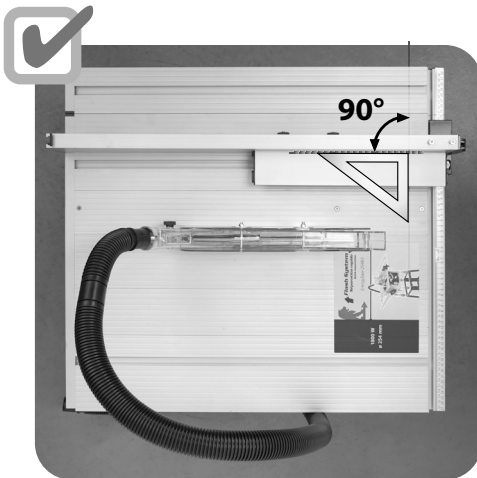
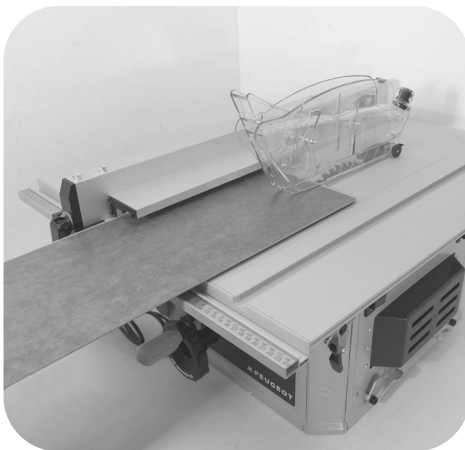
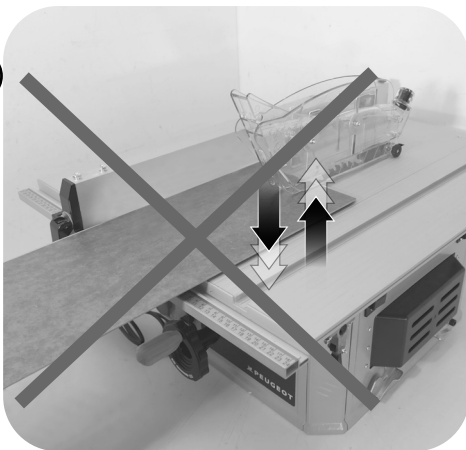

08

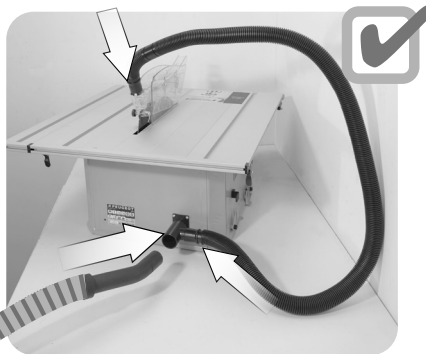
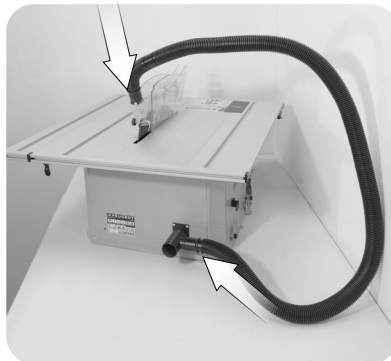
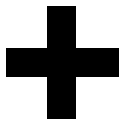
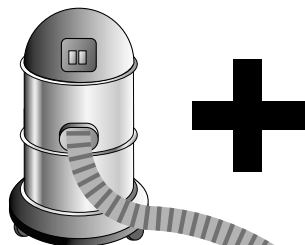
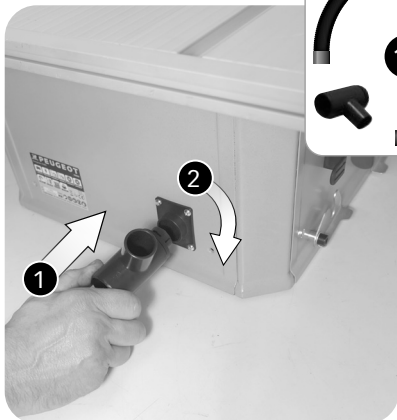

- Cet appareil n'est pas prévu pour être utilisé par des personnes (y compris les enfants) dont les capacités physiques, sensorielles ou mentale sont réduites, ou des personnes dénuées d'expérience ou de connaissance, sauf si elles ont pu bénéficier, par l'intermédiaire d'une personne responsable de leur sécurité, d'une surveillance ou d'instructions préalables concernant l'utilisation de l'appareil.
 - Il convient de surveiller les enfants pour s'assurer qu'ils ne jouent pas avec l'appareil.
- Dit product is niet bedoeld voor gebruik door personen (inclusief kinderen) met een lichamelijke, zintuiglijke of geestelijke vermogens, of gebrek aan ervaring of kennis, tenzij ze zijn gegeven door door een persoon die verantwoordelijk is voor hun veiligheid, toezicht of instructies over het gebruik van het apparaat.
 - Het moet toezicht houden op kinderen om ervoor te zorgen dat zij niet met het apparaat spelen.
- This product is not intended for use by persons (including children) with physical, sensory or mental capabilities, or lack of experience or knowledge, unless they have been given by through a person responsible for their safety, supervision or instruction concerning use of the device.
 - It should supervise children to ensure they do not play with the device.
- Este producto no está diseñado para ser utilizado por personas (incluidos niños) con capacidades físicas, sensoriales o mentales, o la falta de experiencia o conocimiento, a menos que hayan sido dadas por través de una persona responsable de su seguridad, supervisión o instrucciones relativas al uso del dispositivo.
 - Se debe supervisar a los niños para asegurarse de que no jueguen con el dispositivo.
- Este produto não é destinado ao uso por pessoas (incluindo crianças) com capacidades físicas, sensoriais ou mentais, ou falta de experiência ou conhecimento, a menos que tenham sido dadas por através de uma pessoa responsável pela sua segurança, supervisão ou instruções relativas à utilização do dispositivo.
 - Deve vigiar as crianças para garantir que eles não brincam com o dispositivo.

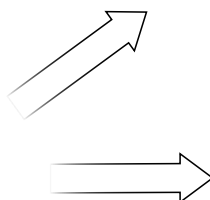
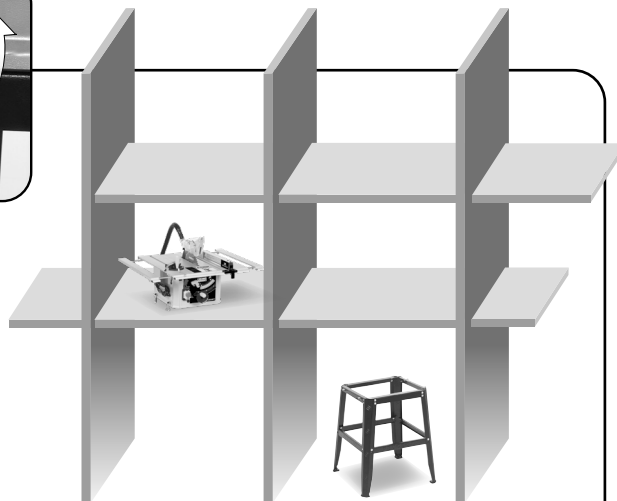
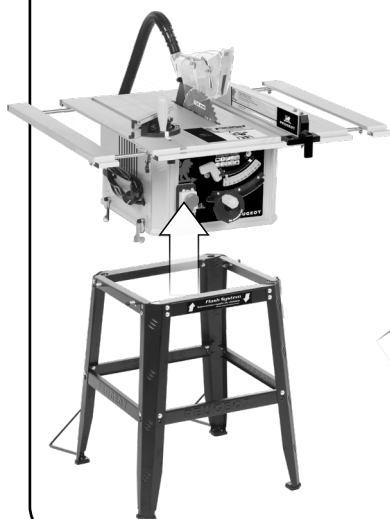
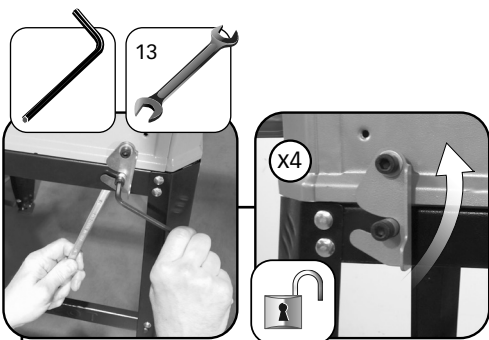
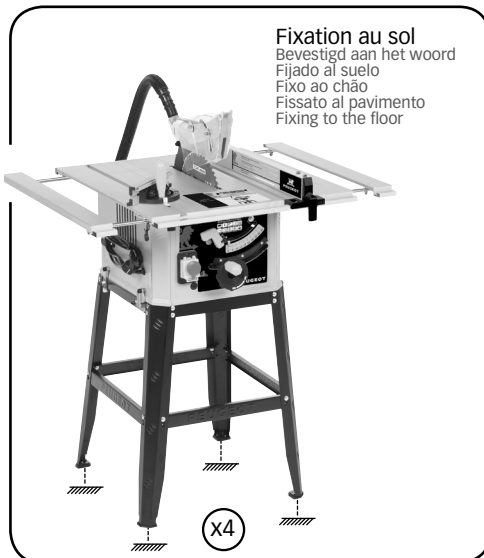

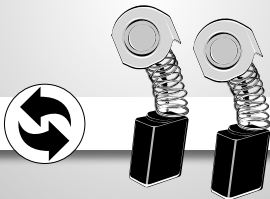
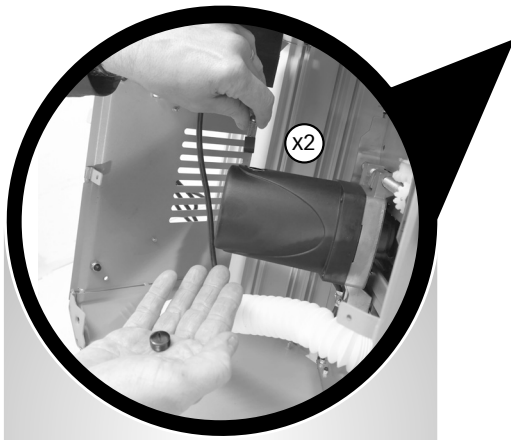
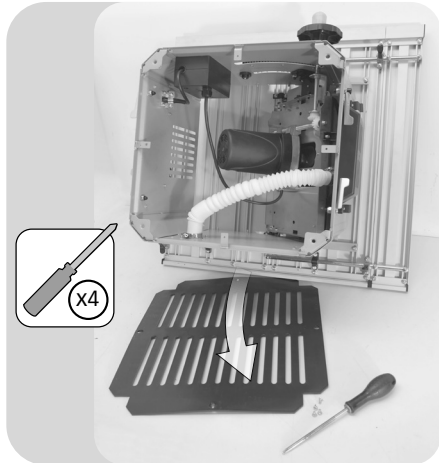
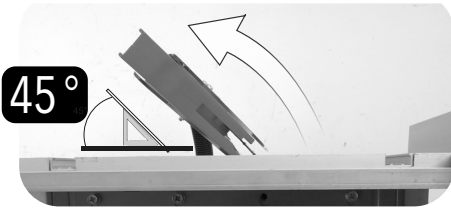



- Nettoyer et aspirer régulièrement les résidus de bois (particulièrement les grilles de passage d'air ou le refroidissement du moteur), afin d'en conserver l'utilisation optimale et de diminuer son échauffement.
 - Reinig en vacuüm regelmatig houtresten (met name luchtdoorgangsroosters of motorkoeling); om het optimale gebruik te behouden en de warming-up te verminderen.
- Residuos de madera limpia y al vacío regularmente (especialmente rejillas de paso de aire o refrigeración del motor), para mantener su uso óptimo y reducir su calentamiento.
- Resíduos de madeira limpa e a vácuo regularmente (especialmente grades de passagem de ar ou arrefecimento do motor), para manter o seu uso ideal e reduzir o seu aquecimento.
- Pulire e aspirare regolarmente i residui di legno (in particolare le griglie di passaggio dell'aria o il raffreddamento del motore), per mantenerne il suo uso ottimale e ridurre il riscaldamento.
 - Clean and vacuum wood residues regularly (especially air passage grids or engine cooling), to maintain its optimal use and reduce its warm-up.

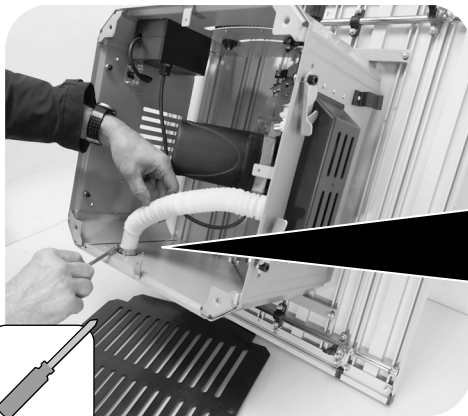
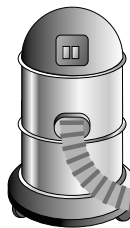
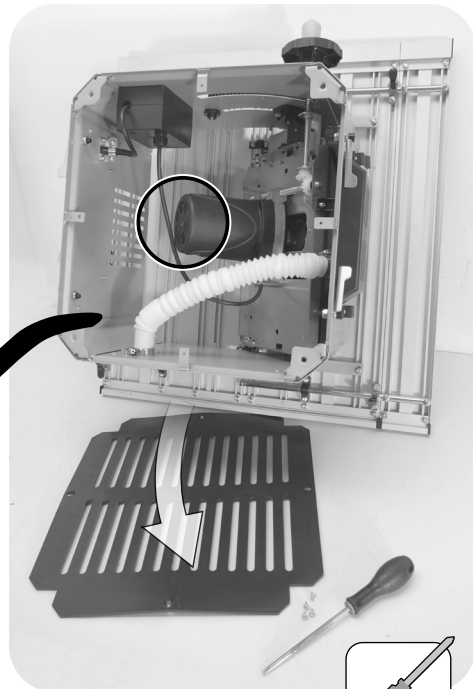
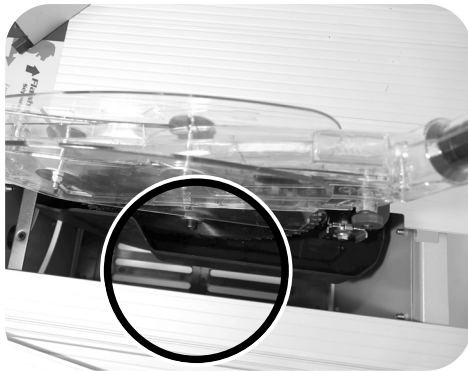

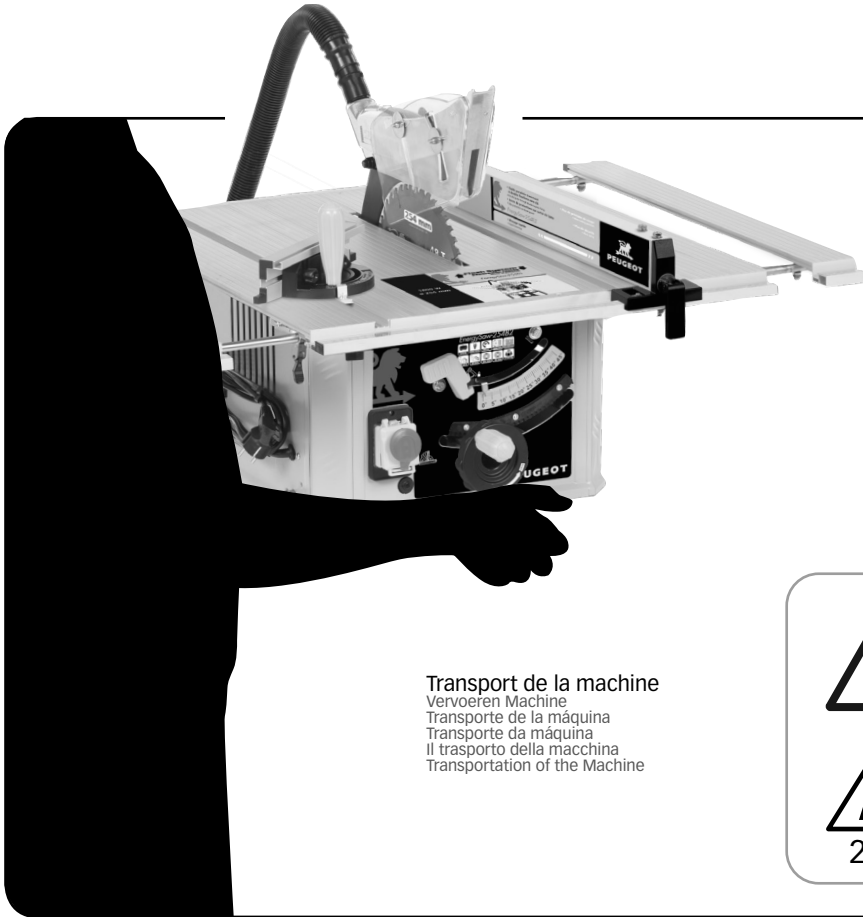

Transport de la machine
Vervoeren Machine
Transporte de la máquina
Transporte da máquina
Il trasporto della macchina
Transportation of the Machine



Description et repérage des organes de la machine**FIG. A & B**

- 01 Carter de protection
- 02 Interrupteur arrêt coup de poing
- 03 Lame
- 04 Inclinaison de lame
- 05 Réglage hauteur de coupe
- 06 Couteau diviseur
- 07 Guide parallèle
- 08 Guide d'angle
- 09 Serrage rapide
- 10 Système anti-bascule
- 11 -
- 12 -
- 13 Extensions de table
- 14 Châssis
- 15 Poussoir
- 16 Flexible aspiration

Contenu du carton**FIG. C****Assemblage de la machine****FIG. D**

- 01 Montage du châssis
- 02 -
- 03 Montage des extensions
- 04 Montage de la lame
- 05 Montage du carter
- 06 -

Fonctionnalité de la machine**FIG. E**

- 01 Mise en marche et arrêt
- 02 Inclinaison de la lame
- 03 Réglage hauteur de coupe
- 04 Utilisation du poussoir
- 05 Utilisation des guides
- 06 -
- 07 -
- 08 Raccordement à un aspirateur
- 09 -
- 10 -

Remplacement des consommables

- 01 Changement de lame (Fig D)
- 02 Changement des charbons
- 03 -

Entretien, recommandations et conseils

- 01 Ne pas utiliser pour la coupe de bois de chauffage
- 02 Le choix de la lame est important. Adapter la denture au matériau à couper.

- <36 dents = Coupe rapide, délignage, sur bois tendre.
 - 36 à 60 dents = Coupe de dérivé du bois (aggloméré, stratifié...). Coupe de bois dur.
 - >60 dents = Coupe précise. Coupe de matière plastique. Coupe de petite section.

- 03 Nettoyage
- 04 Transport
- 05 -
- 06 -

Beschrijving en plaatsbepaling van de onderdelen van de machine

FIG. A & B

- 01 Beschermmantel
- 02 Schakelaar noodstop
- 03 Zaagblad
- 04 Kantelhoek van het zaagblad
- 05 Hoogte-instelling van de snede
- 06 Verdeelmes
- 07 Parallele geleider
- 08 Profielgeleider
- 09 Snelle aanscherping
- 10 Anti-kantelsysteem
- 11 -
- 12 -
- 13 Tafelverlengingen
- 14 Chassis
- 15 Drukknop
- 16 Flexibel afzuigen

Inhoud van het karton

FIG. C

Assemblage van de machine

FIG. D

- 01 Montage van het chassis
- 02 -
- 03 Montage van de verlengingen
- 04 Montage van het zaagblad
- 05 Montage van het carter
- 06 Montage van de batterijen

Functionaliteit van de machine

FIG. E

- 01 Aanzetten en stoppen
- 02 Kantelhoek van het zaagblad
- 03 Hoogte-instelling van de snede
- 04 Gebruik van de drukknoop
- 05 Gebruik van de geleiders
- 06 -
- 07 -
- 08 Aansluiting op een stofzuiger
- 09 -
- 10 -

Vervanging van de accessoires

- 01 Verandering van de lamel (Fig D)
- 02 De kolen veranderen
- 03 -

Reiniging en onderhoud

- 01 Niet gebruiken om brandhout te zagen
- 02 De keuze van het zaagblad is belangrijk. De tanden moeten aangepast zijn aan het te zagen materiaal.

- <36 tanden = snel zagen, markeren op zacht hout.
 - 36 à 60 tanden= zagen van houtderivaten (spaanderplaat, gelaagd hout...). Zagen van hard hout.
 - >60 tanden = nauwkeurig zagen. Zagen van plastics.
 Zagen van dunne stukken.

- 03 Schoonmaak
- 04 Vervoer
- 05 -
- 06 -

Description and location of machine parts

FIG. A & B

- 01 Protection guard
- 02 Punch mechanical NVR switch
- 03 Blade
- 04 Blade inclination
- 05 Setting cutting height
- 06 Board splitter
- 07 Parallel guide
- 08 Angle guide
- 09 Quick tightening
- 10 Anti-tilt system
- 11 -
- 12 -
- 13 Table extensions
- 14 Chassis
- 15 Pushbutton
- 16 Flexible suction

Contents of box

FIG. C

Assembling the machine

FIG. D

- 01 Mounting of chassis
- 02 -
- 03 Mounting of extensions
- 04 Blade assembly
- 05 Mounting of guard
- 06 -

Functions of the machine

FIG. E

- 01 Switch on/off
- 02 Blade inclination
- 03 Setting cutting height
- 04 Use of the pushbutton
- 05 Use of the guides
- 06 -
- 07 -
- 08 Connection to a vacuum cleaner
- 09 -
- 10 -

Replacing consumables

- 01 Changing the blade (Fig D)
- 02 Changing the carbon brushes
- 03 -

Cleaning and maintenance

- 01 Do not use for cutting logs
- 02 The choice of blade is important. Adapt the saw teeth to the material to be cut.

- <36 teeth = Rapid cut, edging, on soft wood.
- 36 to 60 teeth = Cutting wood products (chipboard, laminates etc.). Cutting hard wood.
- >60 teeth = Precise cutting. Cutting plastic.

Cutting small sections.

- 03 Cleaning
- 04 Transport
- 05 -
- 06 -

ES**Descripción y localización de los elementos de la máquina****FIG. A & B**

- 01 Cárter de protección
- 02 Interruptor parada de golpe
- 03 hoja
- 04 Inclinación de la hoja
- 05 Regulación de la altura de corte
- 06 Cuchillo divisor
- 07 Guía paralela
- 08 Guía angular
- 09 Ajuste rápido
- 10 Sistema anti-inclinación
- 11 -
- 12 -
- 13 Extensiones de la mesa
- 14 Bastidor
- 15 Empujador
- 16 Aspiración flexible

Contenido del cartón**FIG. C****Ensamblaje de la máquina****FIG. D**

- 01 Montaje del bastidor
- 02 -
- 03 Montaje de las extensiones
- 04 Montaje de la hoja
- 05 Montaje del cárter
- 06 -

Funcionalidad de la máquina**FIG. E**

- 01 Puesta en marcha y parada
- 02 Inclinación de la hoja
- 03 Regulación de la altura de corte
- 04 Utilización del empujador
- 05 Utilización de las guías
- 06 -
- 07 -
- 08 Empalme con un aspirador
- 09 -
- 10 -

ES**Cambio de los consumibles**

- 01 Cambio de hoja (Fig D)
- 02 Cambiando las brasas
- 03 -

Limpieza y mantenimiento

- 01 No utilizar para cortar leña de calefacción
- 02 La elección de la hoja es importante. Adaptar los dientes al material que se tiene que cortar.

- < 36 dientes = Corte rápido, canteado, en madera blanda.
- 36 a 60 dientes = Corte de derivados de madera (conglomerado, estratificado...). Corte de madera dura.
- > 60 dientes = Corte preciso. Corte de materias plásticas.

Corte de pequeñas secciones.

- 03 Limpieza
- 04 Transporte
- 05 -
- 06 -

Descrição e identificação dos órgãos

FIG. A & B

- 01 Cárter de proteção
- 02 Interruptor paragem de emergência
- 03 Lâmina
- 04 Inclinação da lâmina
- 05 Ajuste da altura de corte
- 06 Lâmina separadora
- 07 Guia paralela
- 08 Guia angular
- 09 Aperto rápido
- 10 Anti-Tilt sistema
- 11 -
- 12 -
- 13 Extensões de mesa
- 14 Chassis
- 15 Empurrador
- 16 Sucção flexível

Conteúdo da caixa

FIG. C

Montagem da máquina

FIG. D

- 01 Montagem do chassis
- 02 -
- 03 Montagem das extensões
- 04 Montagem da lâmina
- 05 Montagem do cárter
- 06 -

Funcionalidade da máquina

FIG. E

- 01 Accionamento e paragem
- 02 Inclinação da lâmina
- 03 Ajuste da altura de corte
- 04 Utilização do empurrador
- 05 Utilização das guias
- 06 -
- 07 -
- 08 Ligação a um aspirador
- 09 -
- 10 -

Substituição de consumíveis

- 01 Substituição da lâmina (Fig D)
- 02 Mudando as brasas
- 03 -

Limpeza e manutenção preventiva

- 01 Não utilizar para o corte de madeira de lenha
- 02 A escolha da lâmina é importante. Adaptar os dentes ao material a cortar.

- <36 dentes = Corte rápido, corte longitudinal, em madeira macia.

36 a 60 dentes = Corte de derivados de madeira (aglomerados, estratificados, etc.). Corte de madeira dura.

- >60 dentes = Corte preciso. Corte de matérias plásticas.

Corte de pequena secção.

- 03 Limpeza
- 04 Transporte
- 05 -
- 06 -

IT**Descrizione e localizzazione degli organi della macchina****FIG. A & B**

- 01 Carter di protezione
- 02 Interruttore arresto di emergenza
- 03 Lama
- 04 Inclinazione della lama
- 05 Regolazione in altezza del taglio
- 06 Coltello divisore
- 07 Guida parallela
- 08 Guida ad angolo
- 09 Serraggio rapido
- 10 Sistema anti-tilt
- 11 -
- 12 -
- 13 Estensioni del tavolo
- 14 Telaio
- 15 Punteria
- 16 -

Contenuto della scatola**FIG. C****Assemblaggio della macchina****FIG. D**

- 01 Montaggio delle pile
- 02 -
- 03 Montaggio delle estensioni
- 04 Montaggio della lama
- 05 Montaggio del carter
- 06 -

Funzionalità della macchina**FIG. E**

- 01 Avvio e arresto
- 02 Inclinazione della lama
- 03 Regolazione in altezza del taglio
- 04 Utilizzazione della punteria
- 05 Utilizzazione delle guide
- 06 -
- 07 -
- 08 Raccordo ad un aspiratore
- 09 -
- 10 -

IT

Sostituzione dei pezzi di ricambio

- 01 Cambiare la lama (Fig D)
- 02 Cambiare le braci
- 03 -

Pulizia e manutenzione

- 01 Non usare per tagliare legna da ardere
- 02 La scelta della lama è importante. Adattare la dentatura al materiale da tagliare.

- <36 denti = Taglio rapido, rifilatura, su legno dolce.
- da 36 a 60 denti= Taglio del derivato del legno (conglomerato, stratificato...). Taglio del legno duro. - >60 denti = Taglio preciso. Taglio di materie plastiche. Taglio di piccole sezioni.

- 03 Pulizia
- 04 Trasporto
- 05 -
- 06 -

<p>EnergySaw-254B3 132003 TS250CN</p>	<p>Scie de table et d'établi Tabel Saw en werkbank Sierra de mesa y banco de trabajo Serra e bancada da tabela Sega da tavolo e banco da lavoro Table and Workbench saw</p>
---	---

	<p>Tension et fréquence assignée: Aangewezen spanning en frequentie: Tensión y frecuencia fijada: Tensão e frequência fixa: Tensione e frequenza assegnata: Nominal frequency and power:</p>	<p>230 V ~ 50 Hz</p>
---	--	----------------------

	<p>Puissance assignée: Onbelast toerental: Potencia fijada: Potência assinada: Potenza assegnata: Nominal power:</p>	<p>S1 SERVICE CONTINU Fonctionnement à charge constante pour atténuer l'équilibre thermique.</p>	<p>1500 W</p>
---	--	---	---------------

	<p>Puissance assignée: Onbelast toerental: Potencia fijada: Potência assinada: Potenza assegnata: Nominal power:</p>	<p>S6 SERVICE ININTERROMPU PERIODIQUE A CHARGE INTERMITTENTE Répétition de cycles identiques, fonctionnement à charge constante et une période à vide sans période de repos.</p>	<p>1800 W (S6 : 40%)</p>
---	--	---	---------------------------

	<p>Vitesse à vide: Leerlaufdrehzahl: Velocidad vacía: Velocità a vuoto: Velocidade no vácuo: No-load speed:</p>	<p>4800 min⁻¹</p>
---	---	------------------------------

	<p>Dimensions lame: Blade sizes: Paneel afmetingen: Dimensiones del panel: Dimensões do painel: Dimensioni del pannello:</p>	<p>ø 254 mm</p>
---	--	-----------------

	<p>Alésage lame: Bore: Blade boring: Perforación de la lámina: Furo lâmina: Foro lama:</p>	<p>ø 30 mm</p>
---	--	----------------

	<p>Lame inclinable: Tilting blade: Tilt Blade: Incline la hoja: Incline Blade: Inclinare lama:</p>	<p>0 - 45°</p>
---	--	----------------

	<p>Dimensions table: table sizes: Lijstgrootte: Tamaño de la tabla: Tamanho da tabela: Dimensioni tavolo:</p>	<p>674 X 715 mm</p>
---	---	---------------------

	<p>Capacités de coupe: Cutting capacities: Snijden capaciteiten: Capacidades de corte: Cortar capacidades: Di taglio:</p>	<p>45° = 63 mm 90° = 73 mm</p>
---	---	------------------------------------

	<p>Lire les instructions avant usage : Lees voor het gebruik de instructies : Léase las instrucciones antes de usar : Ler as instruções antes da utilização : Leggere le istruzioni prima dell'uso : Read the instructions before use :</p>	<p>X</p>
---	---	----------

	<p>Conformité européenne : Voldoet aan de EG-normen : Cumple con las directivas CE : Conforme às normas CE : Conforme alle norme CE : Conforms to EC standards :</p>	<p>X</p>
---	--	----------

	<p>Danger : Gevaar : Peligro : Perigo : Pericolo : Danger :</p>	<p>X</p>
---	---	----------

	<p>Classe d'isolement : 2 Isolatie Klasse : 2 Aislamiento clase : 2 Isolamento classe :2 Isolamento classe :2 Insulation class : 2</p>	<p>X</p>
---	--	----------



	Poids :	27,5 kg
	Gewicht :	
	Peso :	
	Peso :	
	Weight :	

	Porter des lunettes de sécurité :	X
	Draag een veiligheidsbril :	
	Llevar puestas gafas protectoras :	
	Portare de gli occhiali di sicurezza :	
	Utilizar óculos de segurança :	
Wear protective eyewear :		

IP 20	X
--------------	---

	Porter un masque anti-poussière :	X
	Draag een stofmasker :	
	Llevar puesta una careta de protección contra el polvo :	
	Indossare una mascherina anti-polvere :	
	Utilizar uma máscara anti-poeira :	
Wear a dust mask :		

	Niveau de pression acoustique :	92 dB (A)
	Niveau akoestische druk :	
	Nível de presión acústica :	
	Nível de pressão acústica :	
	Livello di pressione acustica :	
Acoustic pressure level :		

	Porter une protection auditive :	X
	Draag gehoorbeschermers :	
	Llevar puesta una protección auditiva :	
	Portare una protezione uditiva :	
	Utilizar uma protecção auditiva :	
Wear hearing protective equipment :		

	Niveau de puissance acoustique :	105 dB (A)
	Niveau akoestisch vermogen :	
	Nível de potencia acústica :	
	Nível de potência acústica :	
	Livello di potenza acustica :	
Acoustic power level :		

	Porter des gants :	X
	Draag handschoenen :	
	Usar guantes :	
	Indossare i guanti :	
	Usar luvas :	
Wear gloves :		

NIVEAU SONORE D'EMISSION:

A WIDE

Pression acoustique LpA poste opérateur 92 dB

incertitude

3

Puissance acoustique LWA 105 dB

incertitude

3

Valeurs déterminées suivant le code d'essai de l'annexe B de la norme

EN 62841-1 avec emploi des normes de base ISO 11201 et ISO 3744.



Les niveaux de pression acoustique obtenus in situ dépendent:

- Des niveaux réels de la machine considérées, en prenant en compte les incertitudes déclarées.
- Du local et de l'installation de la machine. Préférez une pièce dont l'acoustique est plus feutrée. Evitez les pièces vide à grande résonance. Placez-vous auprès d'une fenêtre le cas échéant.
- Des outils montés, des pièces travaillées, des réglages choisis,...

	Risque de sectionnement des doigts ou de la main:	X
	Snijden risico van de vinger of hand:	
Recyclebaar, onder voorbehoud van het sorteren:		
Seccionamiento riesgo del dedo o de la mano:		
	Risco Seccionamento do dedo ou a mão:	X
	Sezionamento rischio del dito o della mano:	





 	Soumis à recyclage :	×
	Niet wegwerpen :	
	Sottoposti a riciclaggio :	
	Sujeitos à reciclagem :	
	Sottoposti a riciclaggio :	
Subjected to recycling :		

FR-Recyclage des déchets:

Les outils, accessoires et leur emballages doivent suivre une voie de recyclage adaptée. Conformément aux directives Européenne 2012/19/UE et 2006/66/CE, les composants d'un produit doivent être séparés, collectés, recyclés ou éliminés en conformité avec les réglementations environnementales en vigueur. Les appareils, batteries, piles, huiles, emballages devront être déposés dans les systèmes d'élimination des déchets spéciaux tels que déchetteries. Renseignez vous auprès de votre commune pour connaître l'organisme le plus proche à même de retraiter ou de collecter ces déchets.

NL-afval recycling:

Gereedschap, accessoires en verpakkingen moeten volgen een pad geschikt is voor recycling. Volgens de Europese richtlijnen 2012/19/UE en 2006/66/CE, de componenten van een product moet worden gescheiden, verzameld, gerecycleerd of verwijderd in overeenstemming met de milieuvorschriften. Apparaten, batterijen, olie, moet de verpakking worden gedeponeerd in de afvalverwerking afval, zoals stortplaatsen. Neem contact op met uw gemeente naar de dichtstbijzijnde agentschap kunnen herhalen of het verzamelen van deze afvalstoffen te vinden.

ES-Reciclado de los residuos:

Las herramientas, los accesorios y los envases tienen que seguir la vía de reciclaje adecuada. En virtud de las directivas europeas 2012/19/UE y 2006/66/CE, los componentes de un producto deben separarse, recogerse, reciclarse o eliminarse de acuerdo con las reglamentaciones medioambientales vigentes. Los aparatos, baterías, pilas, aceites, envases deberán llevarse a los centros de eliminación de residuos especiales tales como los ecoparques. Pedir información al municipio par conocer el centro más cercano apto para reciclar o recoger dichos residuos.

PT-Reciclagem do lixo:

As ferramentas, acessórios e suas embalagens devem seguir um canal de reciclagem adaptado. Conformemente às diretivas europeias 2012/19/UE e 2006/66/CE, os componentes de um produto devem ser separados, recolhidos, reciclados ou eliminados de acordo com as regulamentações ambientais em vigor. Os aparelhos, baterias, pilhas, óleos e embalagens deverão ser depositados nos sistemas de eliminação de detritos especiais, tais como unidades de triagem de detritos. Informar-se junto ao seu concelho municipal para conhecer o órgão mais próximo habilitado a evacuar ou recolher estes detritos.

IT-Riciclaggio dei rifiuti:

Gli apparecchi, i loro accessori ed imballaggi devono essere sottoposti ad un processo di riciclaggio appropriato. In conformità con le direttive europee 2012/19/UE e 2006/66/CE, i componenti di un prodotto devono essere separati, raccolti, riciclati o smaltiti in conformità con le normative ambientali in vigore. Gli apparecchi, le batterie, le pile, gli oli, gli imballaggi dovranno essere conferiti nei sistemi di smaltimento dei rifiuti speciali come le isole ecologiche. Informarsi presso il proprio comune per sapere qual è l'ente più vicino in grado di fare il trattamento o la raccolta differenziata di questi rifiuti

EN-Waste recycling:

The tools, accessories and their packaging must use an appropriate recycling channel. In compliance with European Directives 2012/19/UE and 2006/66/CE, a product's components must be separated, collected, recycled in accordance with the environmental regulations in force. The appliance, batteries, oils and packaging must be deposited in the special waste elimination systems such as the waste collection centres. Ask your commune for information on the nearest organisation in a position to reprocess or collect this waste





EnergySaw-254B3

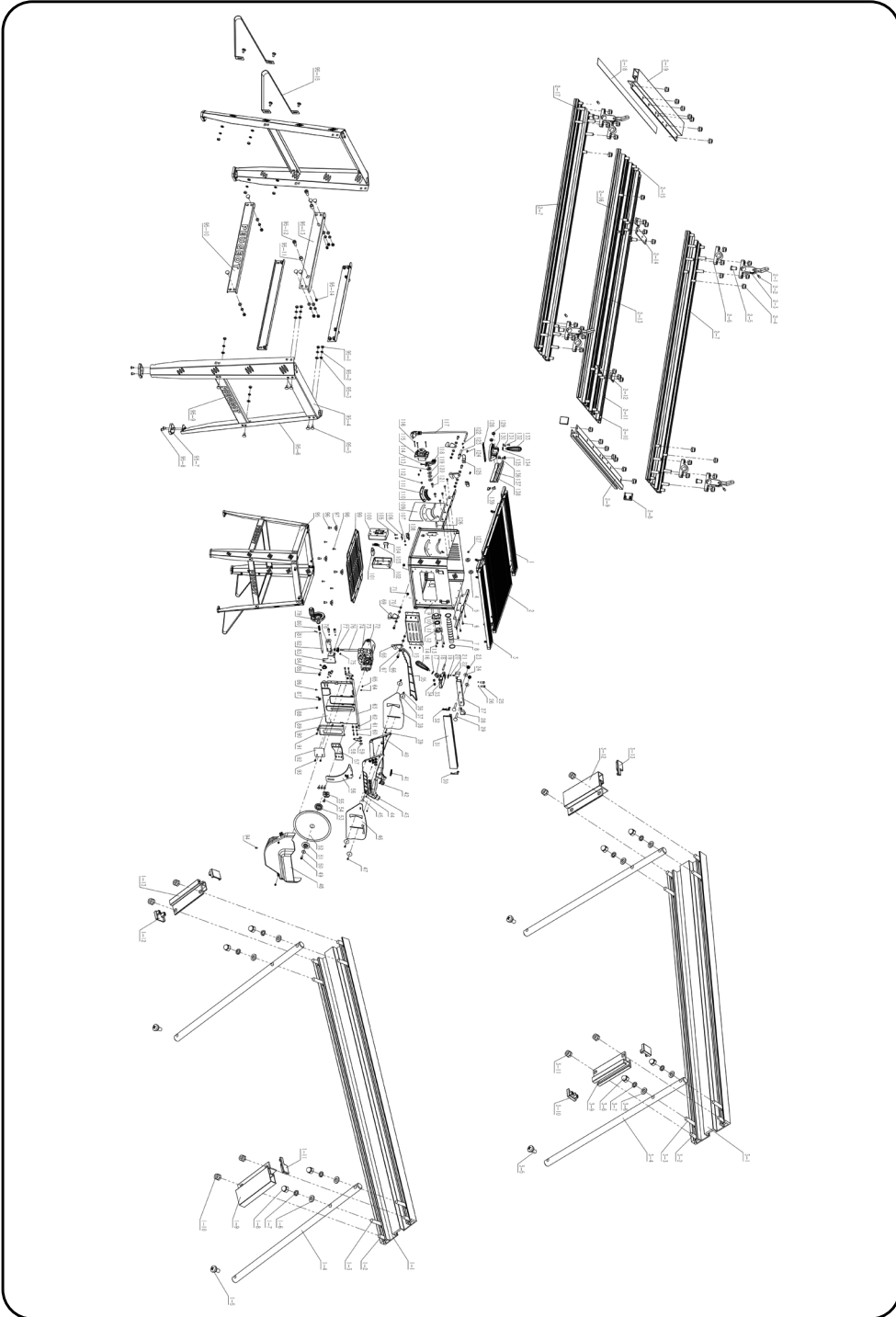



• Guide parallèle traversant à double fixations sans clé
 • Parallel guide through double keyless fitting
 • Joues de protections sur carter de lame
 • Side protection on blade guard

• Plus de précision de coupe
 • More cutting precision
 • Plus de sécurité
 • More safety

EnergySaw-254B3

PEUGEOT

Flash System
 Séparation rapide du châssis
 Quick stand separation

EnergySaw-254B3

1800 W
230V-50Hz
90°
45°
73 mm
63 mm
254 mm
30 mm
4800 min⁻¹
35740 mm³
374 x 715 mm³
27,5 Kg

PEUGEOT

PEUGEOT
 EnergySaw-254B3 132003

1800 W 230V-50Hz 90° 45° 73 mm 63 mm 254 mm 30 mm
 4800 min⁻¹ 35740 mm³ 374 x 715 mm³ 27,5 Kg

DATE: TS250CN
 SERIE: IP20
 Peugeot Outillage - 192, Avenue Yves Farge - 37700 St. Pierre-des-Corps - FRANCE

Flash System
 Séparation rapide
 Quick separation
 EnergySaw-254B3

1800 W
ø 254 mm

IMPORTANT ! BELANGRIJK ! IMPORTANTE!

ASPIRADOR !
 STOFZUIGER: De machine moet worden aangesloten op een stofzuiger!
 ASPIRADOR: La máquina debe estar conectada a un aspirador!
 ASPIRAPULVERE: Deze gel moet worden aangesloten op een stofzuiger!
 ASPIRAPULVERE: Deve essere collegata alla macchina ha un aspirapolvere!

NETTOYAGE !
 Reining: zorg ervoor dat uw machine regelmatig wordt schoongemaakt!
 Limpieza: asegúrese de que su máquina se limpie regularmente!
 Limpoza: certifica-se de que sua máquina é limpa regularmente!
 Pulizia: assicurarsi che la sua macchina venga pulita regolarmente!

NE PAS FORCER SUR LA LAME PENDANT LA COUPE !
 Do not force the blade while cutting!

ASPIRATEUR : Connecter obligatoirement la machine à un aspirateur !
 VACUUM CLEANER: The machine must be connected to a vacuum cleaner!

NETTOYAGE : veiller au nettoyage régulier de votre machine
 Cleaning: make sure your machine is cleaned regularly!

NE PAS FORCER SUR LA LAME PENDANT LA COUPE !
 Do not force the blade while cutting!

* In het niet naleven van deze instructie geldt de garantie bij schade niet.
 * En caso de incumplimiento de estas instrucciones, la garantía no se aplica en caso de daños.
 * No caso de não cumprimento destas instruções, a garantia não se aplica no caso de danos.
 * Nel caso di mancato rispetto delle istruzioni, la garanzia non si applica in caso di danni.

* en cas de non respect de cette consigne, la garantie ne s'applique pas en cas de dommage.
 * If this instruction is not followed, the warranty does not apply in the event of damage.

132003-2-Sticker-B-09-Sécurité aspirateur.indd 1 03/10/2022 10:42





PEUGEOT

DECLARATION CE DE CONFORMITE
DECLARACION DE CONFORMIDAD
DICHIARAZIONE DI CONFORMITA

VERKLARING VAN OVEREENSTEMMING
DECLARAÇÃO DE CONFORMIDADE
DECLARATION OF CE CONFORMITY

Le soussigné,
Ondergetekende,
El suscrito,
O abaixo assinado,
Il sottoscritto,
The undersigned,

Peugeot Outillage

192, Avenue Yves FARGE - 37700 St. PIERRE-des-CORPS - FRANCE
Tél. : 02 36 16 71 46 - Fax : 02 36 16 71 40

Déclare par la présente que,
Verklaart hiermede dat,
Declara por la presente que,
Declara pela presente que,
Dichiare che,
Declares that,

CODE

PEUGEOT / 132003 / EnergySaw-254B3 / TS250CN

Scie de table / Table saw / Sierra de mesa / Serra da tabela / Segá da banco / Tafelzaag

Est conforme et satisfait aux normes CE:
In overeenstemming is met en Voldoet aan EG richtlijnen:
Cumple con la directivas de la CE:
Respeita e está em conformidade com as normas CE:
È conforme alle direttive CEE:
Complies with the EEC standards:

2006/42/EC 2014/30/EU 2011/65/EU 2015/863/EU

EN62841-1:2015
En62841-3-1:2014+A11:2017
AfPS GS 2014 :01 PAK
EN 55014-1:2017/A11:2020
EN 55014-2:2015
EN 61000-3-2:2014
EN IEC 61000-3-2:2019
EN 61000-3-11:2000
EN IEC 61000-3-11:2019

Personne autorisée à
constituer le dossier technique :
Christophe HUREL

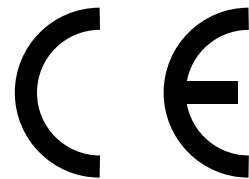

Christophe HUREL,
Président Directeur Général
22/11/2018
Fait à St. Pierre-des-Corps

Attestation de type (EC type) N° M6A 055256 0685 Rev. 00

Rapport (report) N° 4840318110900

TUV SUD Products Service GmbH - Zertifizierstelle
Ridlerstrasse 65 - 80339 München - GERMANY
Enregistré sous (registred under) N° 0123



PEUGEOT

BON DE GARANTIE

1 - Objet de la garantie :

La garantie porte exclusivement sur les vices de fabrication ou les vices de matières.

Elle nous oblige à l'échange ou à la réparation des pièces reconnues hors d'usage.

2 - Durée de la garantie :

La garantie est de 36 mois à dater de la livraison du matériel à l'utilisateur (facture ou ticket de caisse à fournir).

Les échanges ou réparations faites au titre de la garantie ne peuvent avoir pour effet de prolonger celle-ci.

Les frais de port ALLER sont à la charge de l'utilisateur.

3 - Réserves :

La garantie ne s'applique en aucun cas aux réparations effectuées en dehors de nos réparateurs agréés.

En aucun cas, durant la période de garantie, le matériel ne devra être démonté.

GARANTIEKAART

1 - Doel van de garantie:

De garantie heeft uitsluitend betrekking op fabricagefouten of gebreken in materialen.

Het dwingt ons om uit te wisselen of reparatie van erkende onbruikbare onderdelen.

2 - Duur van de garantie:

De garantie bedraagt 36 maanden vanaf de levering van apparatuur voor de gebruiker (factuur of kassabonnetje verstrekken).

De uitwisseling of reparaties onder garantie niet te verlengen.

GO verzendkosten zijn voor rekening van de gebruiker.

3 - Reserves:

De garantie geldt niet in alle reparaties die buiten onze goedgekeurde reparateurs.

In ieder geval gedurende de garantie, moet het materiaal worden verwijderd.

TARJETA DE GARANTÍA

1 - Objeto de la garantía:

La garantía sólo se referirá a los defectos de fabricación o defectos en los materiales.

Nos obliga a cambiar o reparación de las piezas fuera de servicio reconocido.

2 - Duración de la garantía:

La garantía es de 36 meses a partir de la entrega de equipos para el usuario (factura o recibo que se den).

Los intercambios o reparaciones bajo garantía no tendrán que prolongarse.

GO gastos de envío correrán a cargo del usuario.

3 - Reservas:

La garantía no se aplica en todas las reparaciones realizadas fuera de nuestros talleres de reparación autorizados.

En cualquier caso, durante el período de garantía, el material debe ser removido.

CARTÃO DE GARANTIA

1 - Finalidade da garantia:

A garantia só relacionar com defeitos de fabricação ou defeitos em materiais.

Ela nos obriga a troca ou reparo de peças inservíveis reconhecidos.

2 - Duração da Garantia:

A garantia é de 36 meses a partir da entrega de equipamentos para o usuário (factura ou recibo a ser fornecido).

Trocas ou reparos sob a garantia não terá que prorrogá-la.

GO portes serão custeadas pelo usuário.

3 - Reservas:

A garantia não se aplica a quaisquer reparos feitos fora das nossas oficinas aprovadas.

Em qualquer caso, durante o período de garantia, o material deve ser removido.

GARANZIA

1 - Oggetto della garanzia:

La garanzia si riferisce esclusivamente alla difetti di fabbricazione o difetti nei materiali.

Ci costringe a scambio o la riparazione di parti inutilizzabili riconosciuti.

2 - Durata della garanzia:

La garanzia è di 36 mesi dalla consegna delle attrezzature per l'utente (fattura o ricevuta da fornire).

Scambi o riparazioni in garanzia non sarà necessario prolungarla.

GO spese di spedizione sono a carico dell'utente.

3 - Riserve:

La garanzia non si applica in tutte le riparazioni effettuate al di fuori dei nostri riparatori autorizzati.

In ogni caso, durante il periodo di garanzia, il materiale deve essere rimosso.

WARRANTY

1 - Scope of the warranty :

The warranty shall only apply to manufacturing defects or material defects.

We are obliged to exchange or repair parts that are identified as being unusable

2 - Lifetime warranty :

The warranty shall be valid for 36 months from the delivery date of the equipment to the user (invoice or till receipt must be provided).

Exchanges or repairs carried out under the warranty shall not extend the original warranty period.

The user shall be responsible for original shipping charges.

3 - Reservations :

The warranty shall not under any circumstances cover repairs carried out by a non-authorized repairer.

The equipment should not be dismantled under any circumstances during the warranty period.

Date d'achat	Référence machine	Cachet du distributeur
Datum van aankoop	homing	Dealer stempel
Fecha de compra	homing	Comerciante de sellos
Data da compra	homing	Selo Revendedor
Data di acquisto	homing	Timbro del rivenditore
Purchase date	Machine code	Distributor's stamp

SERVICE APRÈS VENTE - AFTER SALE SERVICE

PEUGEOT OUTILLAGE - 192, Avenue Yves Farge - 37700 St. Pierre-des-Corps - FRANCE - Tél. : 02 36 16 71 46 - Fax : 02 36 16 71 40



PEUGEOT OUTILLAGE

Une société du groupe **SIGMA**

192, Avenue Yves Farge
37700 St. Pierre-des-Corps
FRANCE

www.peugeot-outillage.com

