

# PEUGEOT



EnergyGrind-100



**FR** MANUEL D' UTILISATION (Notice originale):  
**NL** HANDBOEK (Vertaling van het oorspronkelijke):  
**ES** MANUAL (Traducción del original):  
**PT** MANUAL (Tradução do manual original):  
**IT** MANUAL (Traduzione dell'avvertenza originale):  
**EN** USING MANUAL (Original manual translation):

*Aiguiseuse  
Natslijpmachine  
Afiladora con agua  
Afiladora al agua  
Affilatrice ad acqua  
Sharpener*

105007-F-2023 0327 PEUGEOT OUTILLAGE

[peugeot-outillage.com](http://peugeot-outillage.com)

FIG. A & B



FIG. C

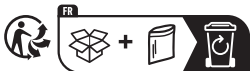
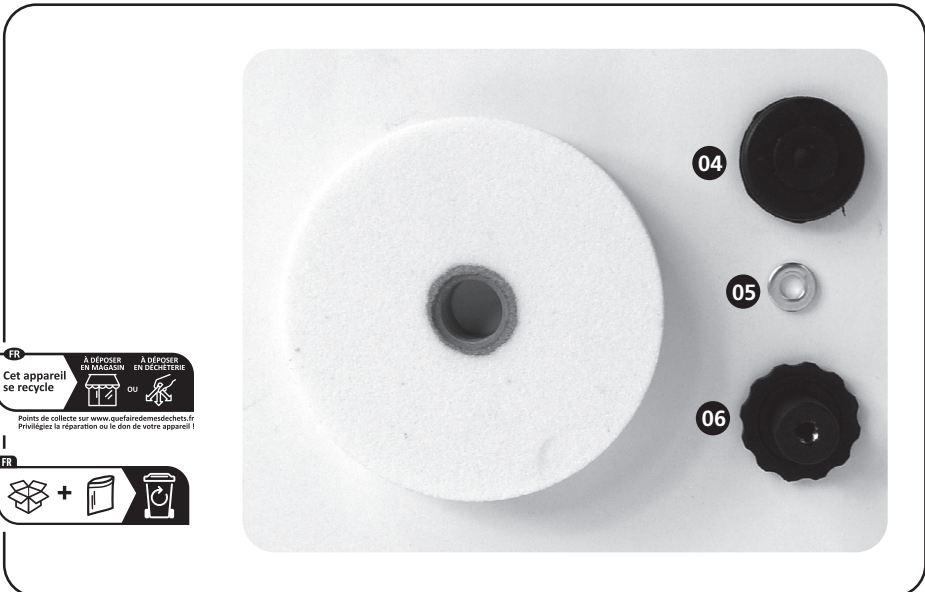

01



05

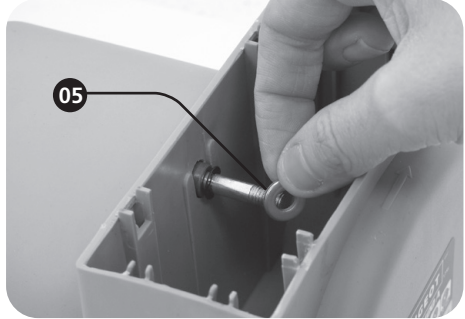

04

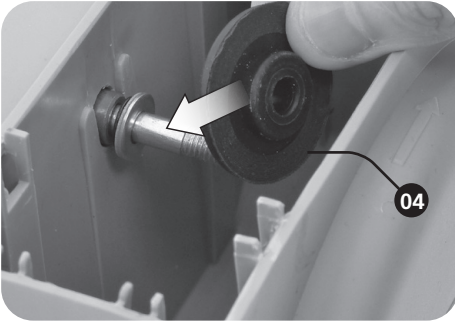

06

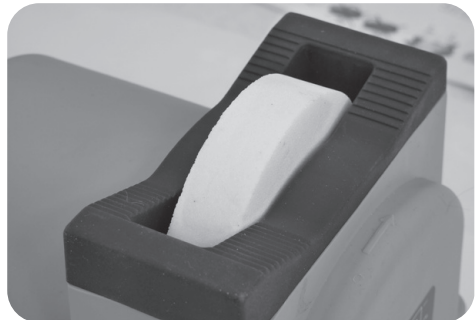
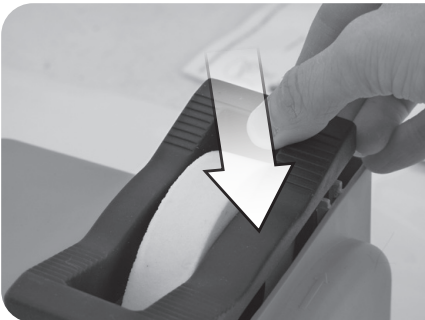
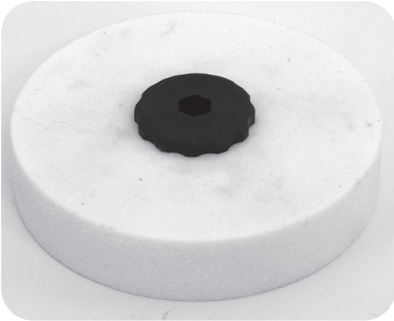
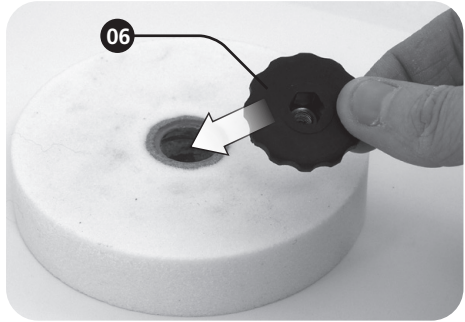

FIG. D

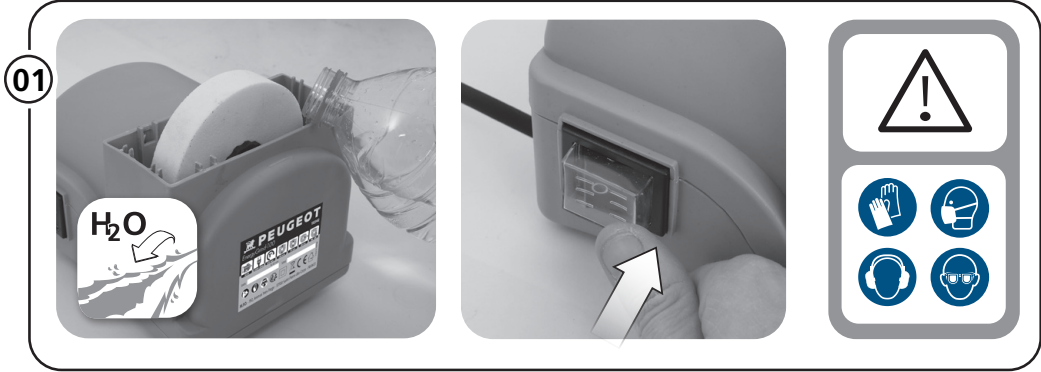
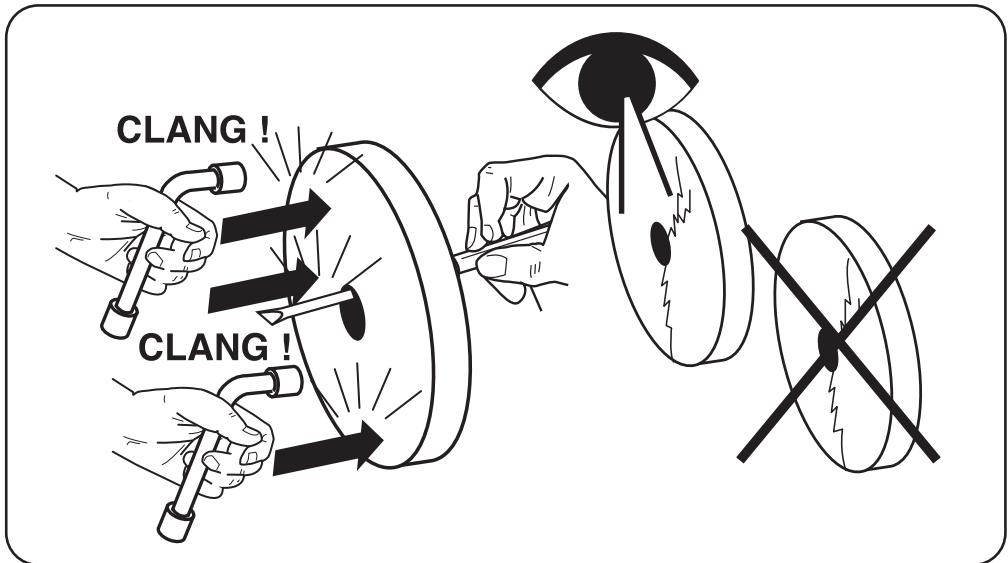





FIG. E





<b>EnergyGrind-100</b> <b>105007</b> <b>SL-LG-100</b>	<b>AIGUISEUSE</b> <b>NATSLIJPMACHINE</b> <b>AFILADORA CON AGUA</b> <b>AFILADORA AL AGUA</b> <b>AFFILATRICE AD ACQUA</b> <b>SHARPENER</b>
---	---

	<b>TENSION ET FRÉQUENCE ASSIÉNÉE:</b> <b>AANGEWEZEN SPANNING EN FREQUENTIE:</b> <b>TENSIÓN Y FRECUENCIA FIJADA:</b> <b>TENSÃO E FREQUÊNCIA FIXA:</b> <b>TENSIONE E FREQUENZA ASSEGNATA:</b> <b>NOMINAL FREQUENCY AND POWER:</b>	<b>230 V - 50 Hz</b>
---	--	----------------------

	<b>PUISSANCE ASSIÉNÉE:</b> <b>ÓNBELAST TOERENTAL:</b> <b>POTENCIA FIJADA:</b> <b>POTÊNCIA ASSINADA:</b> <b>POTENZA ASSEGNATA:</b> <b>NOMINAL POWER:</b>	<b>55 W</b>
--	--	-------------

	<b>VITESSE À VIDE:</b> <b>LEERLAUFDEHZAHL:</b> <b>VELOCIDAD VACÍA:</b> <b>VELOCITÀ A VUOTO:</b> <b>VELOCIDADE NO VÁCUO:</b> <b>NO-LOAD SPEED:</b>	<b>250 min<sup>-1</sup></b>
--	--	-----------------------------

	<b>USAGE INTÉRIEUR UNIQUEMENT</b> <b>INDOOR USE ONLY</b> <b>ALLEEN BINNENSHUIS GEBRUIK</b> <b>SÓLO USO EN INTERIORES</b> <b>APENAS PARA USO INTERNO</b> <b>SOLO USO INTERNO</b>	<b>X</b>
--	--	----------

	<b>CONFORMITÉ EUROPÉENNE :</b> <b>VOLODOET AAN DE EG-NORMEN :</b> <b>CUMPLE CON LAS DIRECTIVAS CE :</b> <b>CONFORME ÀS NORMAS CE :</b> <b>CONFORME ALLE NORME CE :</b> <b>CONFORMS TO EC STANDARDS :</b>	<b>X</b>
--	---	----------

	<b>LIRE LES INSTRUCTIONS AVANT USAGE :</b> <b>LEES VOOR HET GEBRUIK DE INSTRUCTIES :</b> <b>LÉASE LAS INSTRUCCIONES ANTES DE USAR :</b> <b>LER AS INSTRUÇÕES ANTES DA UTILIZAÇÃO :</b> <b>LEGGERE LE ISTRUZIONI PRIMA DELL'USO :</b> <b>READ THE INSTRUCTIONS BEFORE USE :</b>	<b>X</b>
--	---	----------





	<b>DANGER :</b> <b>GEVAAR :</b> <b>PELIGRO :</b> <b>PERIGO :</b> <b>PERICOLO :</b> <b>DANGER :</b>	<b>X</b>
--	---	----------

	<b>ALÉSAGE DE LA MEULE :</b> <b>WHEEL BORE :</b> <b>AGUJERO DE LA RUEDA :</b> <b>ABORRECER DA RODA :</b> <b>FORO DELLA RUOTA :</b> <b>VERVELEN VAN HET WIEL :</b>	<b>16 mm</b>
---	--	--------------

	<b>DIAMÈTRE DE LA MEULE :</b> <b>WHEEL DIAMETER :</b> <b>DIÁMETRO DE LA RUEDA :</b> <b>DIÁMETRO DA RODA :</b> <b>DIAMETRO DELLA RUOTA :</b> <b>DIAMETER VAN HET WIEL :</b>	<b>100 mm</b>
---	---	---------------

	<b>ÉPAISSEUR DE LA MEULE :</b> <b>WHEEL THICKNESS :</b> <b>GROSOR DE LA RUEDA :</b> <b>ESPESURA DA RODA :</b> <b>SPESORE DELLA RUOTA :</b> <b>DIKTE VAN HET WIEL :</b>	<b>20 mm</b>
---	---	--------------

	<b>GRAIN DE LA MEULE :</b> <b>GRAIN SLIJPSCHUIF:</b> <b>GRANO DE LA MUELA:</b> <b>GRÃO REBOLO:</b> <b>GRANO MOLA:</b> <b>GRAIN GRINDING WHEEL:</b>	<b>WA 100</b>
---	---	---------------

   	<b>PORTER DES LUNETTES DE SÉCURITÉ :</b> <b>PORTER UN MASQUE ANTI-POUSSIÈRE:</b> <b>PORTER UNE PROTECTION AUDITIVE:</b> <b>PORTER DES GANTS :</b> <b>SCHUTZBRILLE TRAGEN :</b> <b>STAUBSCHUTZMASKE TRAGEN :</b> <b>GEHÖRSCHUTZ TRAGEN:</b> <b>HANDSCHUHE TRAGEN:</b> <b>DRAAG EEN VEILIGHEIDSBRIL :</b> <b>DRAAG EEN STOFMASKER :</b> <b>DRAAG GEHOORBESCHERMERS:</b> <b>DRAAG HANDSCHOENEN:</b> <b>LLEVAR PUESTAS GAFAS PROTECTORAS :</b> <b>LLEVAR PUESTA UNA CARETA DE PROTECCIÓN CONTRA EL POLVO :</b> <b>LLEVAR PUESTA UNA PROTECCIÓN AUDITIVA:</b> <b>USAR GUANTES</b> <b>PORTARE DE GLI OCCHIALI DI SICUREZZA :</b> <b>INDOSSARE UNA MASCHERINA ANTI-POLVERE :</b> <b>PORTARE UNA PROTEZIONE UDITIVA:</b> <b>INDOSSARE I GUANTI:</b> <b>UTILIZAR ÓCULOS DE SEGURANÇA :</b> <b>UTILIZAR UMA MÁSCARA ANTI-POEIRA :</b> <b>UTILIZAR UMA PROTEÇÃO AUDITIVA:</b> <b>USAR LUVAS:</b> <b>WEAR PROTECTIVE EYEWEAR :</b> <b>WEAR A DUST MASK :</b> <b>WEAR HEARING PROTECTIVE EQUIPMENT:</b> <b>WEAR GLOVES :</b>	<b>X</b>
--	--	----------

	SOUJIS À RECYCLAGE :	X
	NIET WEGWERPEN :	
	SOTTOPOSTI A RICICLAGGIO :	
	SUJEITOS À RECICLAGEM :	
	SOTTOPOSTI A RICICLAGGIO :	
SUBJECTED TO RECYCLING :		

#### FR-RECYCLAGE DES DÉCHETS:

LES OUTILS, ACCESSOIRES ET LEUR EMBALLAGES DOIVENT SUIVRE UNE VOIE DE RECYCLAGE ADAPTÉE. CONFORMÉMENT AUX DIRECTIVES EUROPÉENNES 2012/19/UE ET 2006/66/CE, LES COMPOSANTS D'UN PRODUIT DOIVENT ÊTRE SÉPARÉS, COLLECTÉS, RECYCLÉS OU ÉLIMINÉS EN CONFORMITÉ AVEC LES RÉGLEMENTATIONS ENVIRONNEMENTALES EN VIGUEUR. LES APPAREILS, BATTERIES, PILES, HUILES, EMBALLAGES DEVONT ÊTRE DÉPOSÉS DANS LES SYSTÈMES D'ÉLIMINATION DES DÉCHETS SPÉCIAUX TELS QUE DÉCHETTERIES. RENSEIGNEZ VOUS AUPRÈS DE VOTRE COMMUNE POUR CONNAÎTRE L'ORGANISME LE PLUS PROCHE À MÊME DE RETRAITER OU DE COLLECTER CES DÉCHETS. NL-AFVAL RECYCLING:

GEREEDSCHAP, ACCESSOIRES EN VERPAKKINGEN MOETEN VOLGEN EEN PAD GESCHIKT IS VOOR RECYCLING. VOLGENS DE EUROPESE RICHTLIJNEN 2012/19/UE EN 2006/66/CE, DE COMPONENTEN VAN EEN PRODUCT MOET WORDEN GESCHIEDEN, VERZAMELD, GERECYCLEERD OF VERWIJDERD IN OVEREENSTEMMING MET DE MILIEUVOORSCHRIFTEN. APPARATEN, BATTERIJEN, OLIE, MOET DE VERPAKKING WORDEN GEDEPONEERD IN DE AFVALVERWERKING AFVAL, ZOALS STORTPLAATSEN. NEEM CONTACT OP MET UW GEMEENTE NAAR DE DICHTSTBIJZIJNDE AGENTSCHAP KUNNEN HERHALEN OF HET VERZAMELEN VAN DEZE AFVALSTOFFEN TE VINDEN.

#### ES-RECICLADO DE LOS RESIDUOS:

LAS HERRAMIENTAS, LOS ACCESORIOS Y LOS ENVASES TIENEN QUE SEGUIR LA VÍA DE RECICLAJE ADECUADA. EN VIRTUD DE LAS DIRECTIVAS EUROPEAS 2012/19/UE Y 2006/66/CE, LOS COMPONENTES DE UN PRODUCTO DEBEN SEPARARSE, RECOGERSE, RECICLARSE O ELIMINARSE DE ACUERDO CON LAS REGLAMENTACIONES MEDIOAMBIENTALES VIGENTES. LOS APARATOS, BATERÍAS, PILAS, ACEITES, ENVASES DEBERÁN LLEVARSE A LOS CENTROS DE ELIMINACIÓN DE RESIDUOS ESPECIALES TALES COMO LOS ECOPARQUES. PEDIR INFORMACIÓN AL MUNICIPIO PAR CONOCER EL CENTRO MÁS CERCANO APTO PARA RECICLAR O RECOGER DICHS RESIDUOS.

#### PT-RECICLAGEM DO LIXO:

AS FERRAMENTAS, ACESSÓRIOS E SUAS EMBALAGENS DEVEM SEGUIR UM CANAL DE RECICLAGEM ADAPTADO, CONFORMEMENTE ÀS DIRETIVAS EUROPEIAS 2012/19/UE E 2006/66/CE, OS COMPONENTES DE UM PRODUTO DEVEM SER SEPARADOS, RECOLHIDOS, RECICLADOS OU ELIMINADOS DE ACORDO COM AS REGULAMENTAÇÕES AMBIENTAIS EM VIGOR. OS APARELHOS, BATERIAS, PILHAS, ÓLEOS E EMBALAGENS DEVERÃO SER DEPOSITADOS NOS SISTEMAS DE ELIMINAÇÃO DE DETRITOS ESPECIAIS, TAIS COMO UNIDADES DE TRIAGEM DE DETRITOS. INFORMAR-SE JUNTO AO SEU CONCELHO MUNICIPAL PARA CONHECER O ÓRGÃO MAIS PRÓXIMO HABILITADO A EVACUAR OU RECOLHER ESTES DETRITOS.

#### IT-RICICLAGGIO DEI RIFIUTI:

GLI APPARECCHI, I LORO ACCESSORI ED IMBALLAGGI DEVONO ESSERE SOTTOPOSTI AD UN PROCESSO DI RICICLAGGIO APPROPRIATO. IN CONFORMITÀ CON LE DIRETTIVE EUROPEE 2012/19/UE E 2006/66/CE, I COMPONENTI DI UN PRODOTTO DEVONO ESSERE SEPARATI, RACCOLTI, RICICLATI O SMALTITI IN CONFORMITÀ CON LE NORMATIVE AMBIENTALI IN VIGORE. GLI APPARECCHI, LE BATTERIE, LE PILE, GLI OLI, GLI IMBALLAGGI DOVRANNO ESSERE CONFERITI NEI SISTEMI DI SMALTIMENTO DEI RIFIUTI SPECIALI COME LE ISOLE ECOLOGICHE. INFORMARSI PRESSO IL PROPRIO COMUNE PER SAPERE QUAL È L'ENTE PIÙ VICINO IN GRADO DI FARE IL TRATTAMENTO O LA RACCOLTA DIFFERENZIATA DI QUESTI RIFIUTI.

#### EN-WASTE RECYCLING:

THE TOOLS, ACCESSORIES AND THEIR PACKAGING MUST USE AN APPROPRIATE RECYCLING CHANNEL. IN COMPLIANCE WITH EUROPEAN DIRECTIVES 2012/19/UE AND 2006/66/CE, A PRODUCT'S COMPONENTS MUST BE SEPARATED, COLLECTED, RECYCLED OR ELIMINATED IN ACCORDANCE WITH THE ENVIRONMENTAL REGULATIONS IN FORCE. THE APPLIANCE, BATTERIES, OILS AND PACKAGING MUST BE DEPOSITED IN THE SPECIAL WASTE ELIMINATION SYSTEMS SUCH AS THE WASTE COLLECTION CENTRES. ASK YOUR COMMUNE FOR INFORMATION ON THE NEAREST ORGANISATION IN A POSITION TO REPROCESS OR COLLECT THIS WASTE

	RECYCLABLE, SOUMIS AU TRI SÉLECTIF	X
	RECYCLEERBARE, ONDERWORPEN AAN RECYCLING	
	RECICLABLES, SUJETOS A RECICLAJE	
	RICICLABILI, SOGGETTI A RICICLAGGIO	
	RECICLÁVEIS, SUJEITO À RECICLAGEM	
RECYCLABLE, SUBJECT TO RECYCLING		

	POIDS :	1,7 kg
	GEWICHT :	
	PESO :	
	PESO :	
	WEIGHT :	

	CLASSE D'ISOLEMENT : 2	X
	ISOLATIE KLASSE : 2	
	AISLAMIENTO CLASE : 2	
	ISOLAMENTO CLASSE : 2	
	INSULATION CLASS : 2	



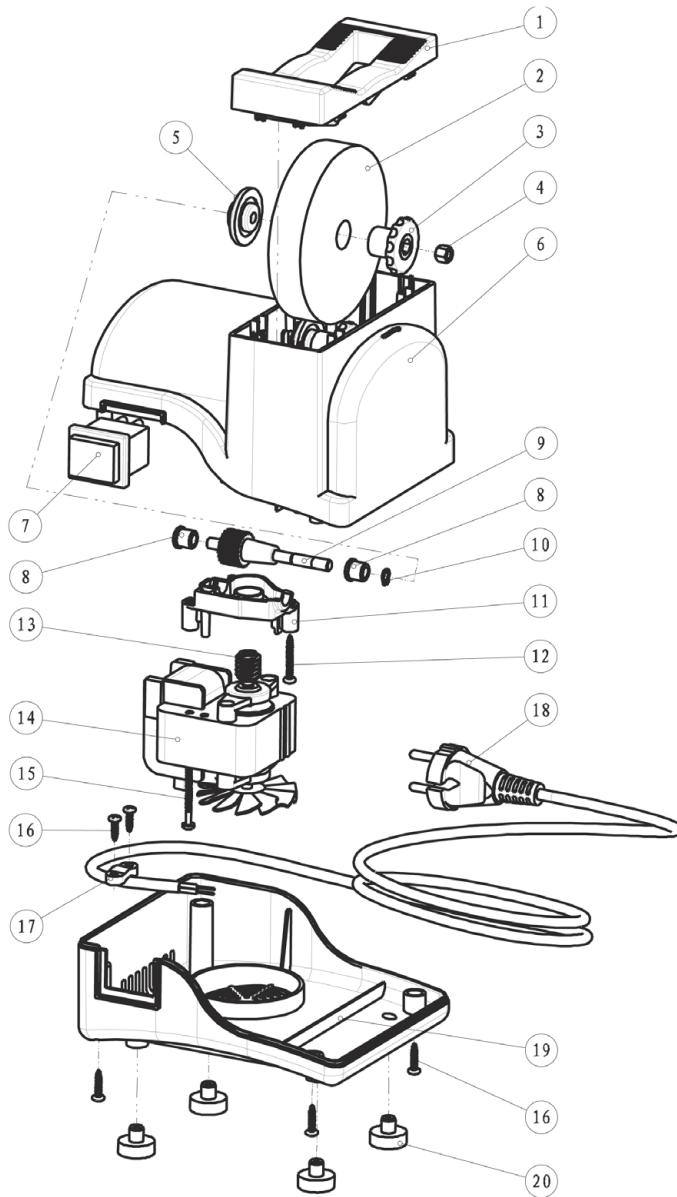





# PEUGEOT

DECLARATION UE DE CONFORMITE  
DECLARACION DE CONFORMIDAD UE  
DICHIARAZIONE DI CONFORMITA UE

UE VERKLARING VAN OVEREENSTEMMING  
DECLARAÇÃO DE CONFORMIDADE UE  
DECLARATION OF UE CONFORMITY

Le soussigné,  
Ondergetekende,  
El suscrito,  
O abaixo assinado,  
Il sottoscritto,  
The undersigned,

## PEUGEOT OUTILLAGE

192, Avenue Yves Farge - 37700 St. Pierre-des-Corps - FRANCE  
Tél. : 02 36 16 71 46 - Fax : 02 36 16 71 40

Déclare par la présente que,  
Verklaart hiermede dat,  
Declara por la presente, que,  
Declara pela presente que,  
Dichiare che,  
Declares that,

### CODE

PEUGEOT / 105007 / EnergyGrind-100 / SL-LG-100

Aiguiseuse / Natslijpmachine / Afiladora con agua / Afiladora al agua / Affilatrice ad acqua / Sharpener

Est conforme et satisfait aux normes CE :  
In overeenstemming is met en Voldoet aan EG richtlijnen :  
Cumple con la directivas de la CE :  
Respeita e está em conformidade com as normas CE :  
È conforme alle direttive CEE :  
Complies with the EEC standards :  
2014/35/UE 2014/30/UE 2011/65/UE+2015/863/UE

EN 60335-2-14:2006+A1+A11+A12  
EN60335-1:2012+A11+A13+A14+A2+A15  
EN62233:2008  
EN IEC 55014-1:2021  
EN IEC 55014-2:2021  
EN IEC 61000-3-2:2019+A1:2021  
EN 61000-3-3:2013+A1:2019+A2:2021

Personne autorisée à  
constituer le dossier technique :  
Christophe HUREL



Christophe HUREL,  
Président Directeur Général  
27/03/2023  
Fait à St. Pierre-des-Corps



# PEUGEOT

## BON DE GARANTIE

### 1 - Objet de la garantie :

La garantie porte exclusivement sur les vices de fabrication ou les vices de matières. Elle nous oblige à l'échange ou à la réparation des pièces reconnues hors d'usage.

### 2 - Durée de la garantie :

La garantie est de 24 mois à dater de la livraison du matériel à l'utilisateur (facture ou ticket de caisse à fournir).

Les échanges ou réparations faites au titre de la garantie ne peuvent avoir pour effet de prolonger celle-ci.

Les frais de port ALLER sont à la charge de l'utilisateur.

### 3 - Réserves :

La garantie ne s'applique en aucun cas aux réparations effectuées en dehors de nos réparateurs agréés.

En aucun cas, durant la période de garantie, le matériel ne devra être démonté.

## GARANTIEKAART

### 1 - Doel van de garantie:

De garantie heeft uitsluitend betrekking op fabricagefouten of gebreken in materialen. Het dwingt ons om uit te wisselen of reparatie van erkende onbruikbare onderdelen.

### 2 - Duur van de garantie:

De garantie bedraagt 24 maanden vanaf de levering van apparatuur voor de gebruiker (factuur of kassabon te verstrekken).

De uitwisseling of reparaties onder garantie niet te verlengen.

GO verzendkosten zijn voor rekening van de gebruiker.

### 3 - Reserves:

De garantie geldt niet in alle reparaties die buiten onze goedgekeurde reparateurs.

In ieder geval gedurende de garantie, moet het materiaal worden verwijderd.

## TARJETA DE GARANTÍA

### 1 - Objeto de la garantía:

La garantía sólo se referirá a los defectos de fabricación o defectos en los materiales. Nos obliga a cambiar o reparación de las piezas fuera de servicio reconocido.

### 2 - Duración de la garantía:

La garantía es de 24 meses a partir de la entrega de equipos para el usuario (factura o recibo que se den).

Los intercambios o reparaciones bajo garantía no tendrá que prolongarse.

GO gastos de envío correrán a cargo del usuario.

### 3 - Reservas:

La garantía no se aplica en todas las reparaciones realizadas fuera de nuestros talleres de reparación autorizados.

En cualquier caso, durante el periodo de garantía, el material debe ser removido.

## CARTÃO DE GARANTIA

### 1 - Finalidade da garantia:

A garantia só relacionar com defeitos de fabricação ou defeitos em materiais. Ela nos obriga a troca ou reparo de peças inseríveis reconhecidos.

### 2 - Duração da Garantia:

A garantia é de 24 meses a partir da entrega de equipamentos para o usuário (factura ou recibo a ser fornecido).

Trocas ou reparos sob a garantia não terá que prolongá-la.

GO porte serão custeadas pelo usuário.

### 3 - Reservas:

A garantia não se aplica a quaisquer reparos feitos fora das nossas oficinas aprovadas.

Em qualquer caso, durante o período de garantia, o material deve ser removido.

## GARANZIA

### 1 - Oggetto della garanzia:

La garanzia si riferisce esclusivamente alla difetti di fabbricazione o difetti nei materiali.

Ci costringe a scambio o la riparazione di parti inutilizzabili riconosciuti.

### 2 - Durata della garanzia:

La garanzia è di 24 mesi dalla consegna delle attrezzature per l'utente (fattura o ricevuta da fornire).

Scambi o riparazioni in garanzia non sarà necessario prolungarla.

GO spese di spedizione sono a carico dell'utente.

### 3 - Riserve:

La garanzia non si applica in tutte le riparazioni effettuate al di fuori dei nostri riparatori autorizzati.

In ogni caso, durante il periodo di garanzia, il materiale deve essere rimosso.

## WARRANTY

### 1 - Scope of the warranty :

The warranty shall only apply to manufacturing defects or material defects.

We are obliged to exchange or repair parts that are identified as being unusable

### 2 - Lifetime warranty :

The warranty shall be valid for 24 months from the delivery date of the equipment to the user (invoice or bill receipt must be provided).

Exchanges or repairs carried out under the warranty shall not extend the original warranty period.

The user shall be responsible for original shipping charges.

### 3 - Reservations :

The warranty shall not under any circumstances cover repairs carried out by a non-authorized repairer.

The equipment should not be dismantled under any circumstances during the warranty period.

DATE D'ACHAT	RÉFÉRENCE MACHINE	CACHET DU DISTRIBUTEUR
DATUM VAN AANKOOP	HOMING	DEALER STEMPEL
FECHA DE COMPRA	HOMING	COMERCIANTE DE SELLOS
DATA DA COMPRA	HOMING	SELO REVENDEDOR
DATA DI ACQUISTO	HOMING	TIMBRO DEL RIVENDITORE
PURCHASE DATE	MACHINE CODE	DISTRIBUTOR'S STAMP

## SERVICE APRÈS VENTE - AFTER SALE SERVICE

PEUGEOT OUTILLAGE - 192, Avenue Yves FARGE - 37700 St. PIERRE-des-CORPS - FRANCE - Tél. : 02 36 16 71 44 - Fax : 02 36 16 71 40