

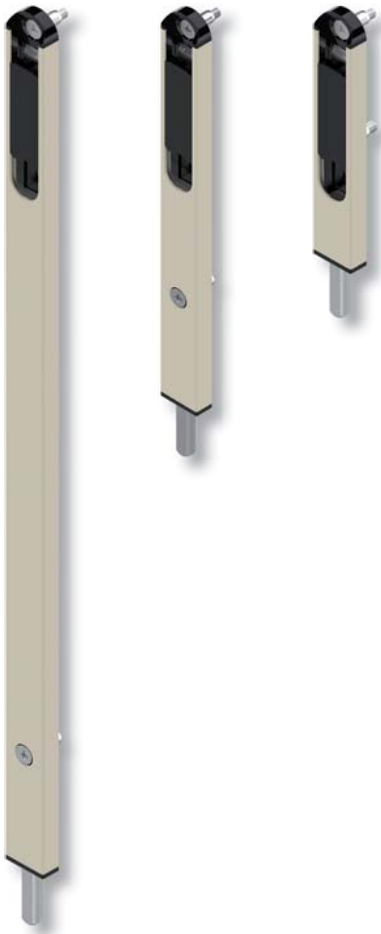





"DATOR"

Verrous de condamnation en feuillure

Conforme à la norme EN 12051



Désignation	Référence	Hauteur
Verrou à levier . Corps en aluminium . Points de fixation et levier en zamak . Pêne en acier . Fixation fournie . Livré sans gâche	DS6680 	170mm
	DS6840 	260mm
	DS6850 	510mm

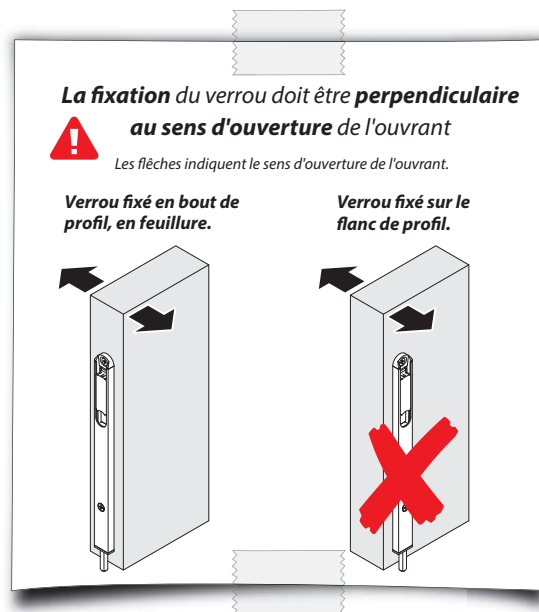

Gâches pour verrous DATOR



DS6866  **Gâche haute**
En aluminium
Fixation par vis Ø5 non fournies.



DS6865 **Gâche basse**
En inox
Fixation par vis Ø4 non fournies.

"DATOR"

Verrous de condamnation en feuillure



Conforme à la norme EN 12051

DS6840

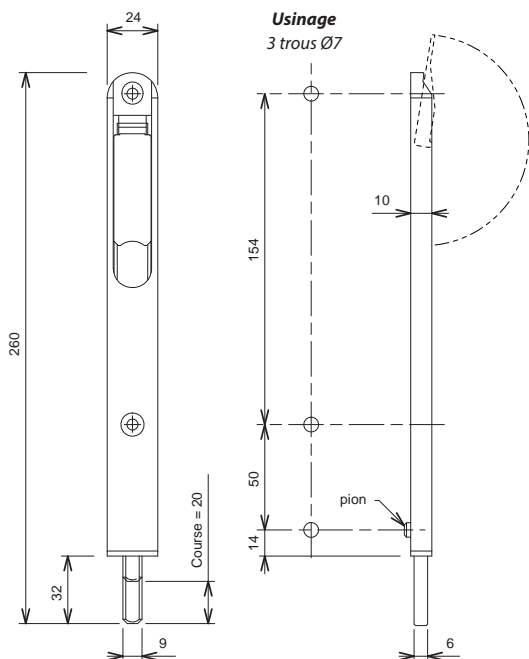

DS6866

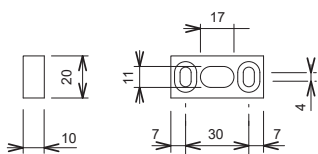

DS6865

