

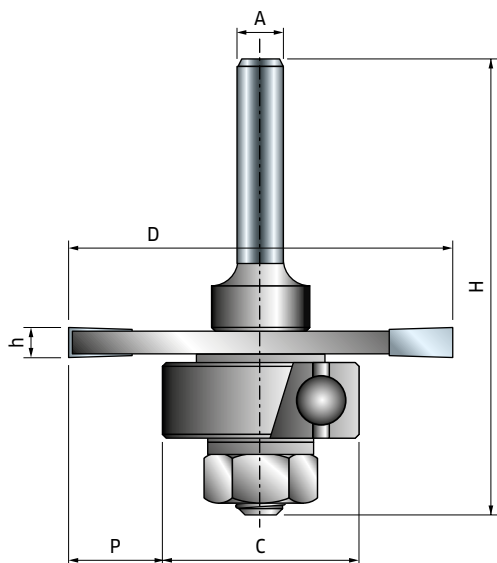





Ensembles pour joints à biscuits Biscuit jointer cutter sets

Pour la coupe de tous composites, contreplaqué, bois dur et tendre. Utilisation avec des défonceuses manuelles ou montées sur table.
Faire plusieurs passages pour la suppression de grandes quantités de matériau.

Cuts all composites, plywood, hardwood and softwood. Use on hand held or table mounted portable router machines.
Use multiple passes when removing large quantities of material.



D mm	h mm	H mm	A mm	C mm	Z	tr/min max. Max RPM	Code Code	SAP SAP
50,8	3,97	60,3	8	26-34	3	24.000	63-60908P	F03FR02146

Pièces détachées Spare parts	Dimensions Dimensions mm	Code Code	SAP SAP
 Écrou Hex / Hex nut	7,94 x 6,75	2610M BB9	F03F010003
 Rondelle / Ring	17 x 8,4 x 1,6	2617M AG9	F03F010005
 Rondelle / Ring	14 x 8,4 x 1,6	2617M BG9	F03FR01668
 Réducteur / Bussola	26 x 10 x 8	RB62M 1249	F03F011417
 Réducteur / Bussola	30 x 10 x 8	RB62M 1289	F03F011418
 Réducteur / Bussola	34 x 10 x 8	RB62ME DA9	F03FR01146

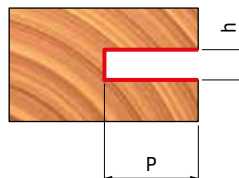
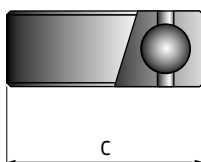

P mm	C mm
8,4	Ø 26
10,4	Ø 30
12,4	Ø 34