

Nombre de points

Entraxes

Largeur de têtère



Verrouillage

Tours de clé

Mécanisme

Réversibilité

Carré

Normes - Réglementation



Autres informations: serrure sans rappel du pêne 1/2 tour à la clé

Réf.: 6570.xx.xC

Réf.: 6570.xx.2C

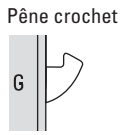
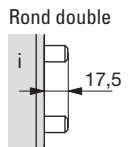
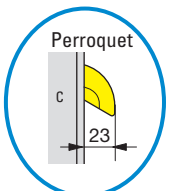
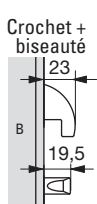
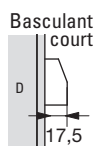
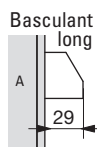

- **Têtère U 1/2 tour** larg. 14 mm
- **À relevage de béquille**
  - 1 - **Manœuvre** des pênes basculants par relevage de la béquille.
  - 2 - **Verrouillage** du pêne central et des pênes basculants à la clé
- Pênes basculants type « perroquet » (pour rattrapage du jeu dit « effet bilame ») et pêne central avec protection anti-sciage
- Livré avec 2 gâches spéciales à rampe ép: 4 mm pour les pênes perroquet

- **Têtère plate 24 x 2,5 1/2 tour** larg. 11,5 mm, compatible avec les gâche réglable
- **À relevage de béquille**
  - 1 - **Manœuvre** des pênes basculants par relevage de la béquille.
  - 2 - **Verrouillage** du pêne central et des pênes basculants à la clé
- Pênes basculants type « perroquet » (pour rattrapage du jeu dit « effet bilame ») et pêne central avec protection anti-sciage
- Livré avec 2 gâches spéciales à rampe ép: 4 mm pour les pênes perroquet
- **Flat faceplate 24 x 2.5, 11.5 mm wide latch, compatible with adjustable strikes**
- **Handle lift operated**
  - 1 - For opening & closing, the pivoting bolts are operated by lifting the handle
  - 2 - For locking, the central bolt and the pivoting bolts are operated by the key
- "Parrot" type pivoting bolts (compensating play from "bimetal effect") and saw resistant central bolt
- Supplied with two special 4mm thick ramp type strikes for parrot bolts

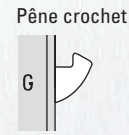
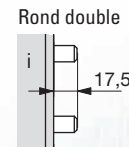
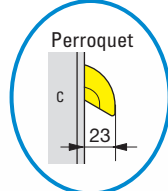
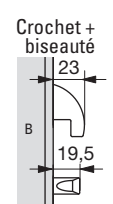
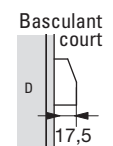
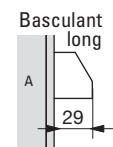

| A  | B  | C  | 24 x 6     |            |            |
|----|----|----|------------|------------|------------|
|    |    |    | 24 x 6     | 24 x 6     | 22 x 2,5   |
| 21 | 36 | 15 | 6570.36.0C |            | 6570.36.1C |
| 24 | 39 | 15 | 6570.39.0C |            | 6570.39.1C |
| 26 | 41 | 15 | 6570.41.0C | 6570.41.4C | 6570.41.1C |
| 30 | 45 | 15 | 6570.45.0C | 6570.45.4C | 6570.45.1C |

Gabarits de copiage : ref. 2836.03.1

| A  | B  | C  | 24 x 2,5   |
|----|----|----|------------|
|    |    |    | 24 x 2,5   |
| 25 | 40 | 15 | 6570.40.2C |
| 30 | 45 | 15 | 6570.45.2C |

Gabarits de copiage : ref. 2836.03.1



Réf. : 6570.xx.0C  
6570.xx.1C  
6570.xx.4C

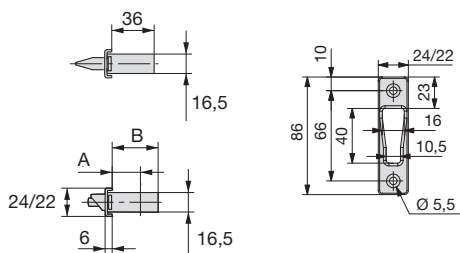
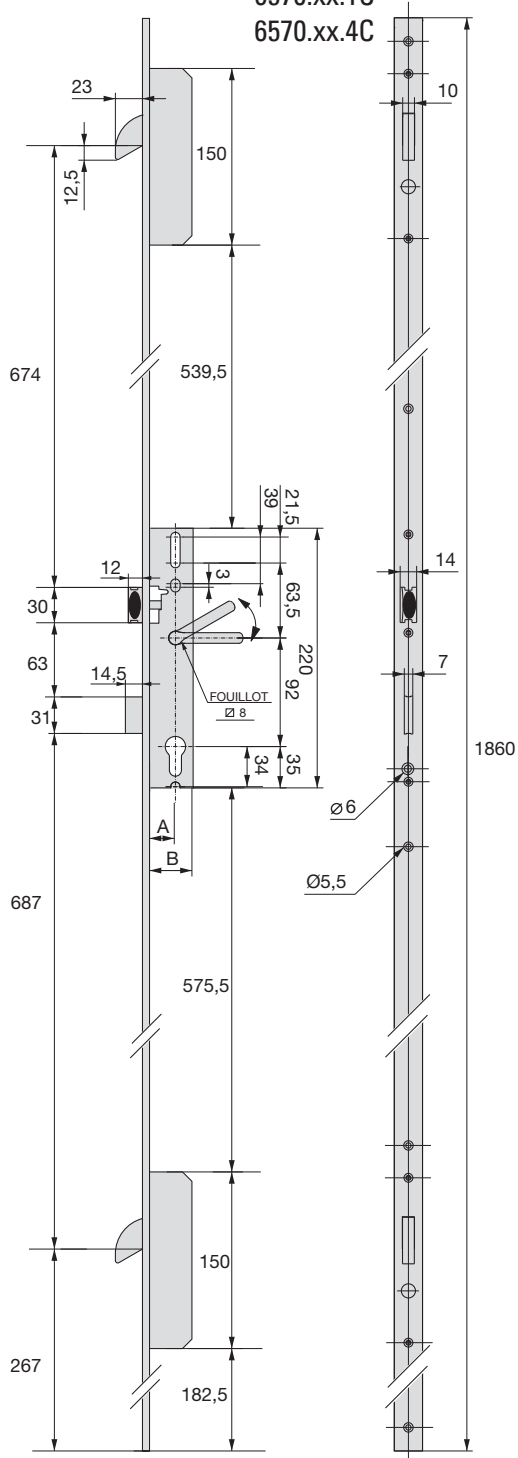

Gâche H et B. ép: 4 mm

Réf. : 6570.xx.2C

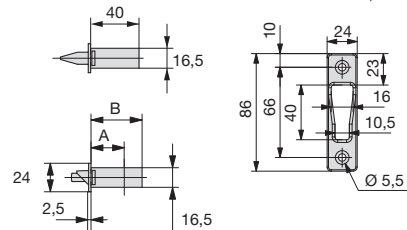
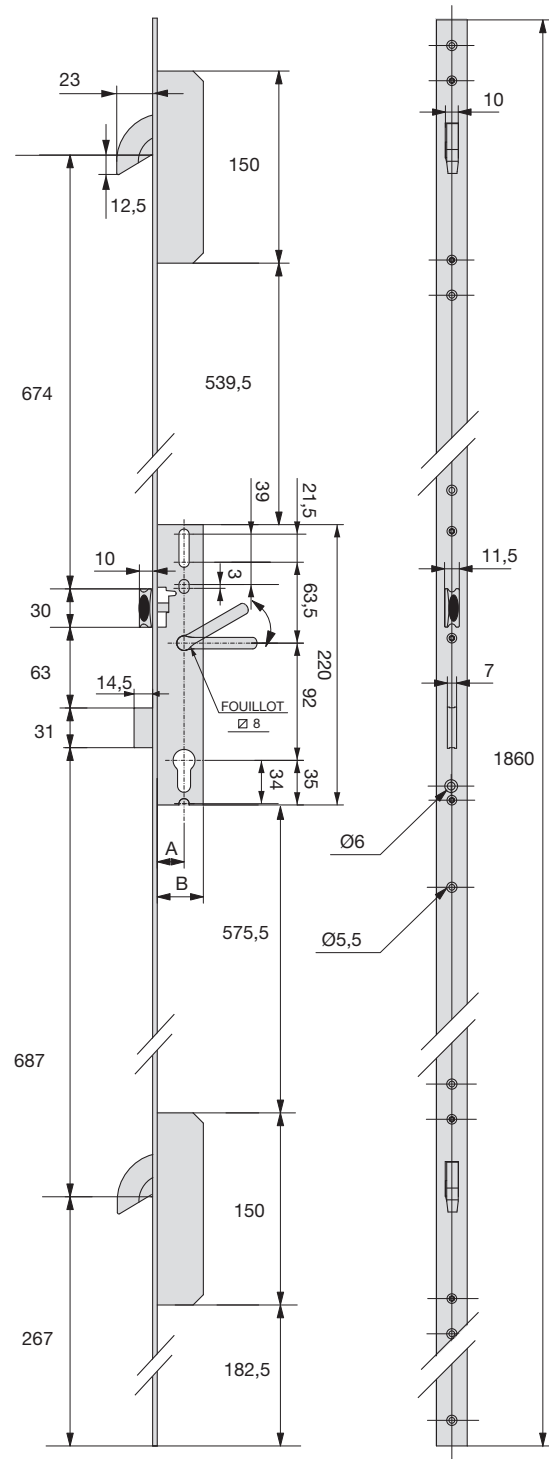

Gâche H et B. ép: 4 mm