



## Bimetal air duct thermometer BiTh 63 LKF

Part no. 65608211

Bimetal air duct thermometer BiTh LKB / BiTh LKF

### benefits

- ranges: -30/+50, -20/+60, -20/+40, 0/60 °C
- brass stem
- with adjustable mounting flange (stainless steel)

### Application

Air conditioning, ventilation

### Technical Specifications

#### Type

D2

#### Nominal size

63

#### measuring element

Bimetal helix

#### accuracy class

2 (EN 13190)

#### ranges °C

-20/+60

#### application area

Full scale value

#### Degree of protection

IP 41 (EN 60529)

#### Connection

Stem: Brass, Ø 9 mm

LKF

Mounting flange, Plastic, Ø 60 mm

#### mounting position

centre back

#### Dial

Aluminium, white

Scaling: black

#### Pointer

Plastic, black

#### Housing

Sheet steel, galvanised

#### push on bezel

Sheet steel, nickel-plated

#### window

LKF

Plastic

### Options

- other ranges
- other stem lengths
- Accuracy class 1
- steel flange  $\varnothing$  40/80 mm

**Technical Drawings**

**LKF - centre back connection**

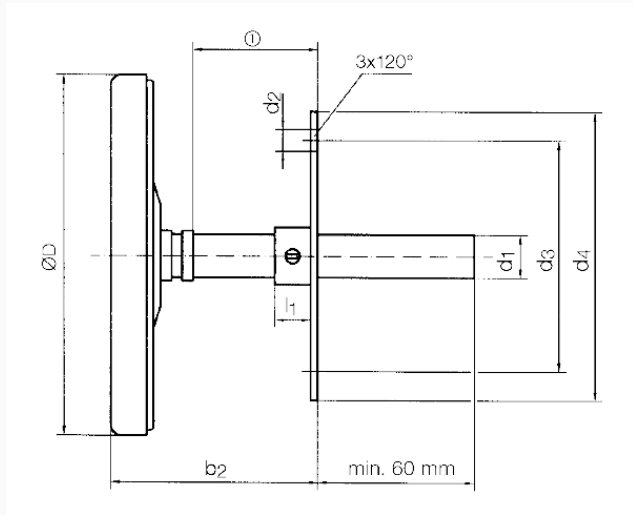

adjustable

**Dimensions (mm)**

NG	D	d1	d2	d3	d4	l1
63	63	9	12	51	60	10
80	80	9	12	51	60	10
100	100	9	12	51	60	10

**Versions**

Type	housing $\varnothing$	Stem length	Connec-tion	Range	Stem length	Type	Type	Part no.
BiTh 63 LKF D211	63 mm	100 mm	Mounting flange	-20/+60 °C		BiTh 63 LKF	D211	● 65608211

- in-stock items
- Non-stock items