



Bimetal air duct thermometer BiTh 63 LKF

Part no. 65635211

Bimetal air duct thermometer BiTh LKB / BiTh LKF

benefits

- ranges: -30/+50, -20/+60, -20/+40, 0/60 °C
- brass stem
- with adjustable mounting flange (stainless steel)

Application

Air conditioning, ventilation

Technical Specifications

Type

D2

Nominal size

63

measuring element

Bimetal helix

accuracy class

2 (EN 13190)

ranges °C

0/60

application area

Full scale value

Degree of protection

IP 41 (EN 60529)

Connection

Stem: Brass, Ø 9 mm

LKF

Mounting flange, Plastic, Ø 60 mm

mounting position

centre back

Dial

Aluminium, white

Scaling: black

Pointer

Plastic, black

Housing

Sheet steel, galvanised

push on bezel

Sheet steel, nickel-plated

window

LKF

Plastic

Options

- other ranges
- other stem lengths
- Accuracy class 1
- steel flange \varnothing 40/80 mm

Technical Drawings

LKF - centre back connection

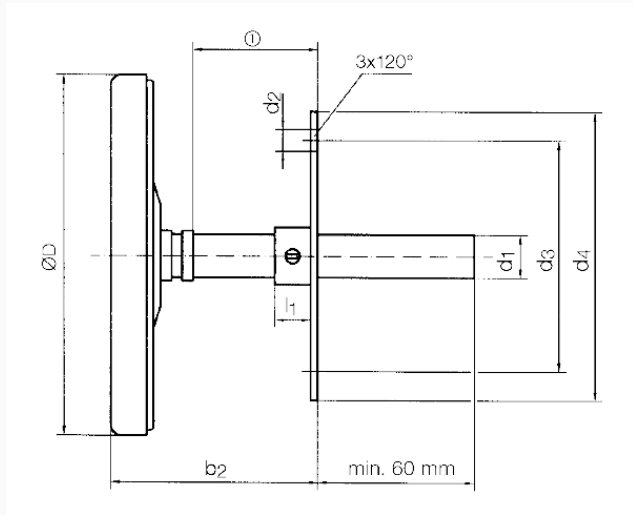

adjustable

Dimensions (mm)

NG	D	d1	d2	d3	d4	l1
63	63	9	12	51	60	10
80	80	9	12	51	60	10
100	100	9	12	51	60	10

Versions

Type	housing \varnothing	Stem length	Connec-tion	Range	Stem length	Type	Type	Part no.
BiTh 63 LKF D211	63 mm	200 mm	Mounting flange	0/60 °C		BiTh 63 LKF	D211	● 65635211

- in-stock items
- Non-stock items