

bimetal standard thermometer BiTh 100 K

Part no. 63699

Bimetal thermometers BiTh K with brass thermowell

benefits

- ranges: -20/+60, 0/60, 0/120, 0/160 °C
- thermowell brass with optional self-sealing thread with PTFE sealing ring
- stem brass or aluminium

Application

Heating, plumbing

Technical Specifications

Nominal size
100

measuring element
Bimetal helix

accuracy class
2 (EN 13190)

ranges °C
0/60

application area
Full scale value

Operating pressure at thermowell
max. 6 bar

Options

- nominal size 63 (bottom back)

Connection

Stem: brass or aluminium, Ø 9 mm
Thermowell: G½B, Brass, Ø 12 mm, removable

mounting position

centre back

Dial

Plastic, white
Scaling: black

Pointer

Plastic, black

Housing

ABS, black

window

Plastic, clipped in

Technical Drawings

Centre back connection, NG 63 – 80 – 100

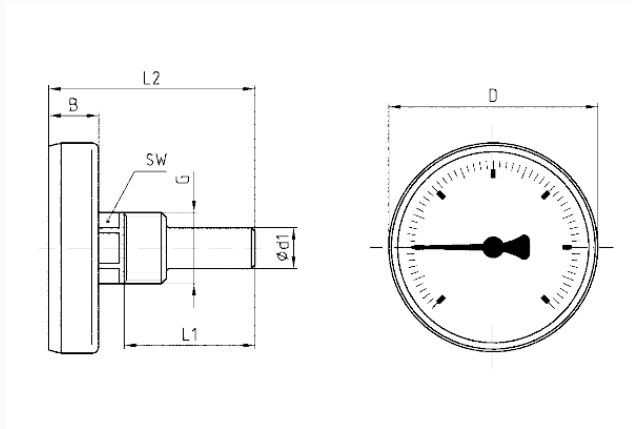

Dimensions (mm)

NG	B	D	d1	G	L1	L2	SW
63	14,7	62	12	G½B	40	61	19
63	14,7	62	12	G½B	63	85	19
63	14,7	62	12	G½B	100	122	19
63	14,7	62	12	G½B	150	172	19
80	14,8	79	12	G½B	40	61	19
80	14,8	79	12	G½B	63	85	19
80	14,8	79	12	G½B	100	122	19
80	14,8	79	12	G½B	150	172	19
100	15	100	12	G½B	40	61	19
100	15	100	12	G½B	63	85	19
100	15	100	12	G½B	100	122	19
100	15	100	12	G½B	150	172	19
100	15	100	12	G½B	200	222	19

Versions

Type	housing ø	Conne- tion	mounting position	Range	Stem length	Stem length	Type	Part no.
BiTh 100 K	100 mm	Thermo- well	centre back	0/60 °C	63 mm		BiTh 100 K ●	63699

- in-stock items
- Non-stock items