

## bimetal standard thermometer BiTh 63 ST

**Part no. 64040**

**bimetal standard thermometer**

### benefits

- ranges:-20/+60, 0/60, 0/120, 0/160 °C
- brass thermowell
- stem brass or aluminium

### Application

Heating, plumbing

### Technical Specifications

**Nominal size**

63

**measuring element**

Bimetal helix

**accuracy class**

2 (EN 13190)

**ranges °C**

-20/+60

**application area**

Full scale value

**Operating pressure at thermowell**

max. 6 bar

**Connection**

Stem: brass or aluminium, Ø 9 mm

Thermowell: G½B, brass or aluminium, Ø 9 mm

**mounting position**

bottom

**Dial**

Up to 120 °C: Plastic, white

≥ 160 °C: Aluminium, white

Scaling: black

**Pointer**

Plastic, black

**Housing**

Sheet steel, galvanised

**push on bezel**

Sheet steel, nickel-plated

**window**

Plastic

**Options**

- other ranges
- Nominal size 34, 160

**Technical Drawings**

**Bottom connection**

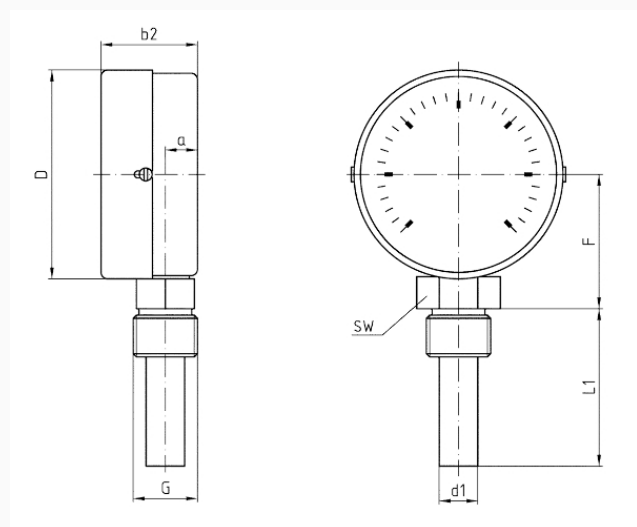

**Dimensions (mm)**

NG	a	b2	D	d1	F	G	L1	SW
63	10	35	63	12	29,3	G½B	40	19/22
63	10	35	63	12	29,3	G½B	63	19/22
63	10	35	63	12	29,3	G½B	100	19/22
63	10	35	63	12	29,3	G½B	150	19/22
80	10	33	80	12	47,3	G½B	40	19/22
80	10	33	80	12	47,3	G½B	63	19/22
80	10	33	80	12	47,3	G½B	100	19/22
80	10	33	80	12	47,3	G½B	150	19/22
100	10	40,5	100	12	59,3	G½B	40	19/22
100	10	40,5	100	12	59,3	G½B	63	19/22
100	10	40,5	100	12	59,3	G½B	100	19/22
100	10	40,5	100	12	59,3	G½B	150	19/22

**Versions**

Type	housing $\varnothing$	mounting position	Range	Stem length	Type	Type	Part no.
BiTh 63 ST	63 mm	bottom	-20/+60 °C	63 mm	BiTh 63 ST	<input type="radio"/>	64040

- in-stock items
- Non-stock items