

bimetal standard thermometer BiTh 80 ST

Part no. 64064

bimetal standard thermometer

benefits

- ranges:-20/+60, 0/60, 0/120, 0/160 °C
- brass thermowell
- stem brass or aluminium

Application

Heating, plumbing

Technical Specifications

Nominal size

80

measuring element

Bimetal helix

accuracy class

2 (EN 13190)

ranges °C

0/120

application area

Full scale value

Operating pressure at thermowell

max. 6 bar

Connection

Stem: brass or aluminium, Ø 9 mm

Thermowell: G½B, brass or aluminium, Ø 9 mm

mounting position

bottom

Dial

Up to 120 °C: Plastic, white

≥ 160 °C: Aluminium, white

Scaling: black

Pointer

Plastic, black

Housing

Sheet steel, galvanised

push on bezel

Sheet steel, nickel-plated

window

Plastic

Options

- other ranges
- Nominal size 34, 160

Technical Drawings

Bottom connection

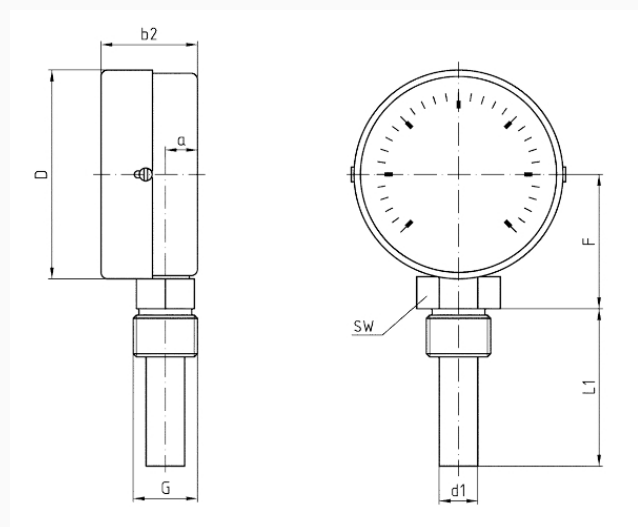

Dimensions (mm)

NG	a	b2	D	d1	F	G	L1	SW
63	10	35	63	12	29,3	G½B	40	19/22
63	10	35	63	12	29,3	G½B	63	19/22
63	10	35	63	12	29,3	G½B	100	19/22
63	10	35	63	12	29,3	G½B	150	19/22
80	10	33	80	12	47,3	G½B	40	19/22
80	10	33	80	12	47,3	G½B	63	19/22
80	10	33	80	12	47,3	G½B	100	19/22
80	10	33	80	12	47,3	G½B	150	19/22
100	10	40,5	100	12	59,3	G½B	40	19/22
100	10	40,5	100	12	59,3	G½B	63	19/22
100	10	40,5	100	12	59,3	G½B	100	19/22
100	10	40,5	100	12	59,3	G½B	150	19/22

Versions

Type	housing \varnothing	mounting position	Range	Stem length	Type	Type	Part no.
BiTh 80 ST	80 mm	bottom	0/120 °C	63 mm	BiTh 80 ST	●	64064

- in-stock items
- Non-stock items