



## industrial thermometer VMTh 110

**Part no. 64117**

**industrial thermometer**

### benefits

- extremely robust due to full metal housing
- vibration-resistant glass thermometer
- Stainless steel version possible
- excellent readability due to blue thermometer filling

### Application

Heating, industry, mechanical engineering

### Technical Specifications

#### Nominal size

110 mm30 mm

#### Upper part

Aluminium, V-shaped, polished, anodised brass-coloured. Numbers of measuring range printed in black at the right part of the scale below the anodised layer. Adjustable by means of brass nut (spanner size SW 22) so that readings from any angle are possible.

#### Glass insert (capillary)

prismatic capillary, completely made of glass,  $\varnothing$  6 mm. Graduation marks of the capillary burnt in, black, completely resistant. Main graduation marks corresponding to the numbers printed on the housing are especially bold and easy to read.

#### thermometer filling

Standard version: Blue liquid indicating from -60 to +200 °C.

### Options

- other ranges
- other stem lengths
- other stem materials

#### Stem

brass,  $\varnothing$  10 mm, with fixed thread G $\frac{1}{2}$ B. Stainless steel version on request.

#### accuracy

DIN 16195

#### ranges °C

0/160

#### mounting position

straight

#### Immersion pipe length

63 mm

- other connection threads
- Upper part anodised aluminium-coloured
- Upper part made of plastic
- thermowells

**Technical Drawings**

mounting position straight

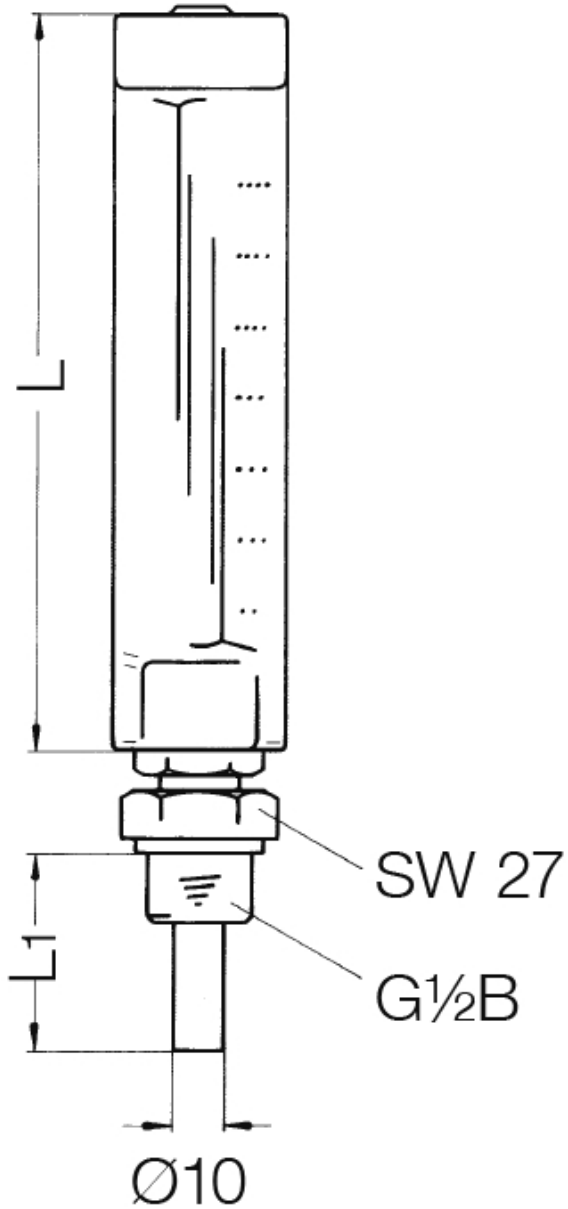

**Dimensions (mm)**

Typ	L		L <sub>1</sub>		
VMTh 110	110	40	63	100	160
VMTh 150	150	40	63	100	160
VMTh 200	200	40	63	100	160

## Versions

	Nominal size	Version	mounting position	Range	Stem length	Type		Part no.
VMTh 110	110 x 30 mm	DIN 16181	straight	0/160 °C	63 mm	VMTh 110	●	64117

● in-stock items

● Non-stock items