

## combined thermometer/pressure gauge TM80

**Part no. 63343**

**combined thermometer/pressure gauge**



### benefits

- pressure and temperature measurement with at a single measuring point
- with self-sealing connection thread for fast installation
- Bottom connection or back connection
- with mounting valve for easy replacement without downtime

### Application

For liquid media which are not highly viscous, do not crystallise and do not attack copper alloys. For combined measurement of pressure and temperature, especially in heating systems and heating boilers.

### Description

The combined thermometer/pressure gauge / thermo-hydrometer consists of a Bourdon tube measuring system for pressure measurement and a bimetal measuring system for simultaneous temperature measurement. Both values are measured and displayed by a single gauge. A self-closing mounting valve enable easy replacement of the measuring instrument without requiring the system to be drained. An optional M18 x 1 to G $\frac{1}{4}$  adapter is available if the combined thermometer/pressure gauge has to be mounted into an existing thermowell with M18 x 1 female thread.

### Technical Specifications

#### Type

D2

#### Nominal size

80

#### accuracy class

Pressure gauges: 2.5 (EN 837-1/6)

#### Range

pressure: 0/10 bar

temperature: 20/120 °C

#### application area

static load:  $\frac{3}{4}$  x full scale value

dynamic load:  $\frac{2}{3}$  x full scale value

short-term: Full scale value

temperature: Full scale value

#### Operating temperature range

Medium: max. 120 °C

Ambient: -20/+60 °C

#### Temperature performance

pressure: Indication error when the temperature of the measuring system deviates from the normal temperature of 20 °C:

at rising temperature approx.  $\pm 0.4 \%$ /10 K

falling temperature approx.  $\pm 0.4 \%$ /10 K

of full scale value

#### Degree of protection

IP 32 (EN 60529)

#### Connection

Brass, centre back

G $\frac{1}{4}$ B with mounting valve G $\frac{1}{4}$  to R $\frac{1}{2}$

**Measuring element**

pressure: Bourdon tube, Copper alloy  
 temperature: Bimetal spiral

**Dial**

Plastic, white  
 Scaling: black with red/blue circular arcs

**Pointer**

pressure: Plastic, black  
 temperature: Plastic, Red

**Housing**

D2  
 Sheet steel, black

**window**

Plastic, clipped in with adjustable red mark

**Options**

- Adapter M 18 x 1 to G $\frac{1}{4}$
- special scales
- other process connections

**Technical Drawings**

**Mounting valve and adapter**

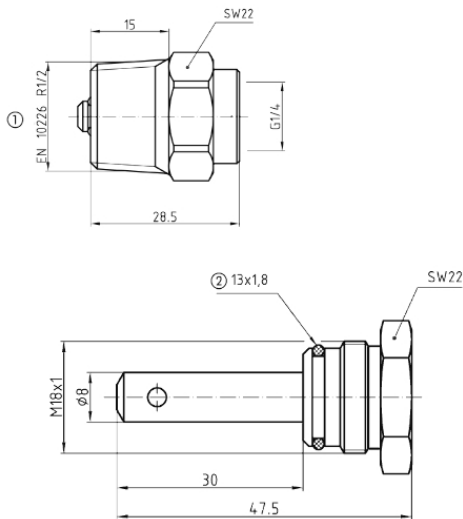

**Dimensions (mm)**

pipe thread  
 O ring (NBR)

**Versions**

housing ø	Housing	mounting position	Adapter	Range		Type		Part no.
				pressure	temperatu- re			
80 mm	Sheet steel, black	centre back		0/10 bar	20/120 °C	TM80 D211	<span style="color: blue;">●</span>	63343

● in-stock items

● Non-stock items