



Standard Bourdon tube pressure gauges RF80

Part no. 85164101

Standard Bourdon tube pressure gauges Type D1

benefits

- for pneumatic and heating system applications
- Design as per EN 837-1
- Accuracy class 1.6
- corrosion-resistant, highly impact-resistant plastic housing
- many customised versions available

Application

For gaseous and liquid media which are not highly viscous, do not crystallise and do not attack copper alloys.
! For measuring gas or vapour, observe the table "Selection Criteria as per EN 837-2"!

Technical Specifications

Type

D1

Nominal size

80

accuracy class (EN 837-1/6)

1.6

ranges (EN 837-1/5)

see ordering table

application area

static load: $\frac{3}{4}$ x full scale value
dynamic load: $\frac{2}{3}$ x full scale value
short-term: Full scale value

Operating temperature range

Medium: max. 60 °C
Ambient: -20/+60 °C

Temperature performance

Indication error when the temperature of the measuring system deviates from the normal temperature of 20 °C:
at rising temperature approx. ± 0.4 %/10 K
falling temperature approx. ± 0.4 %/10 K
of full scale value

Degree of protection

IP 32 (EN 60529)

Connection

Brass, bottom

Measuring element

Bourdon tube, Copper alloy
 ≤ 60 bar: "C" type tube
> 60 bar: helical tube

movement

Brass

Dial
Plastic, white
Scaling: black

Pointer
Plastic, black

Housing
ABS, black, highly impact-resistant and corrosion-resistant

window
Plastic, clipped in
NG 80
with adjustable red reference pointer

Options

- throttle screw
- Reference pointer
- special scales
- other process connections

Technical Drawings

NG 80 – bottom connection

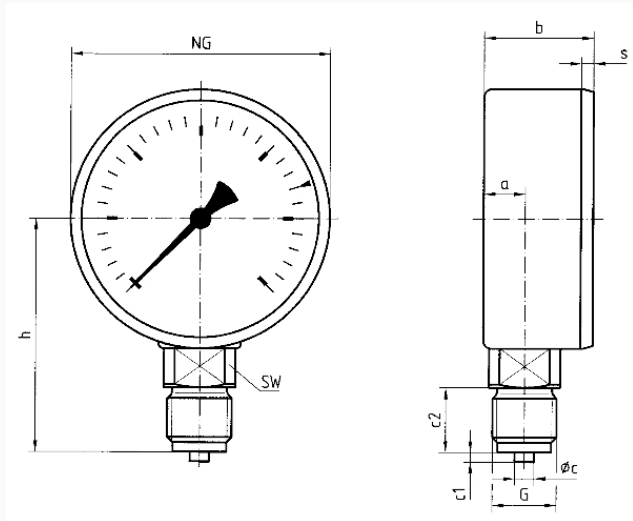

Dimensions (mm)

NG	a	b	Øc	c1	c2	G	h	s	SW
80	12,8	32,8	6	3	20	G¼B	72	2,8	22

Versions

Range	Mounting type	Type	Part number
0/6 bar	direct	RF80 D101	85164101

- in-stock items
- Non-stock items