



Standard Bourdon tube pressure gauges RF50

Part no. 85063111

Standard Bourdon tube pressure gauges Type D1

benefits

- for pneumatic and heating system applications
- Design as per EN 837-1
- Accuracy class 1.6
- corrosion-resistant, highly impact-resistant plastic housing
- many customised versions available

Application

For gaseous and liquid media which are not highly viscous, do not crystallise and do not attack copper alloys.

! For measuring gas or vapour, observe the table "Selection Criteria as per EN 837-2"!

Technical Specifications

Type

D1

Nominal size

50

accuracy class (EN 837-1/6)

1.6

ranges (EN 837-1/5)

see ordering table

application area

static load: $\frac{3}{4}$ x full scale value

dynamic load: $\frac{2}{3}$ x full scale value

short-term: Full scale value

Operating temperature range

Medium: max. 60 °C

Ambient: -20/+60 °C

Temperature performance

Indication error when the temperature of the measuring system deviates from the normal temperature of 20 °C:

at rising temperature approx. $\pm 0.4 \%$ /10 K

falling temperature approx. $\pm 0.4 \%$ /10 K

of full scale value

Degree of protection

IP 32 (EN 60529)

Connection

Brass, centre back

Measuring element

Bourdon tube, Copper alloy

≤ 60 bar: "C" type tube

> 60 bar: helical tube

movement

Brass

Dial

Plastic, white

Scaling: black

Pointer
Plastic, black

window
Plastic, clipped in
NG 50

Housing
ABS, black, highly impact-resistant and corrosion-resistant

Options

- throttle screw
- Reference pointer
- special scales
- other process connections

Technical Drawings

NG 40/50/63 – centre back connection

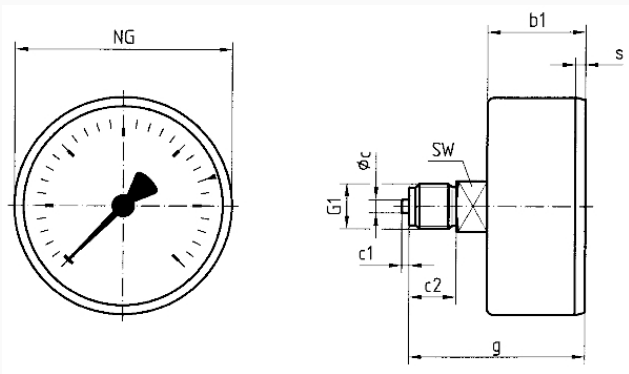

Dimensions (mm)

NG	b1	øc	c1	c2	g	G1	s	SW
40	25	4	2	10	41,5	G½B	3	12
50	27,1	5	2	13	47,1	G¼B	3,8	14
63	30,4	5	2	13	50,4	G¼B	3,7	14

Versions

Range	Mounting type	Type	Part number
0/4 bar	direct	RF50 D111	85063111

- in-stock items
- Non-stock items