



## Standard Bourdon tube pressure gauges RF40

Part no. 85017201

Standard Bourdon tube pressure gauges Type D2

### benefits

- for pneumatic and heating system applications (NG 40 - 50 - 63)
- for domestic technology and mechanical engineering applications (NG 80 - 100 - 160)
- robust steel housing
- window with adjustable reference pointer (NG 80 - 100)
- with reference pointer on dial (NG 160)
- Accuracy class 1.6
- many customised versions available

### Application

For gaseous and liquid media which are not highly viscous, do not crystallise and do not attack copper alloys.  
! For measuring gas or vapour, observe the table "Selection Criteria as per EN 837-2"!

### Technical Specifications

#### Type

D2

#### Nominal size

40

#### accuracy class (EN 837-1/6)

1.6

#### ranges (EN 837-1/5)

see ordering table

#### application area

static load:  $\frac{3}{4}$  x full scale value  
dynamic load:  $\frac{2}{3}$  x full scale value  
short-term: Full scale value

#### Operating temperature range

Medium: max. 60 °C  
Ambient: -20/+60 °C

#### Temperature performance

Indication error when the temperature of the measuring system deviates from the normal temperature of 20 °C:  
at rising temperature approx.  $\pm 0.4$  %/10 K  
falling temperature approx.  $\pm 0.4$  %/10 K  
of full scale value

#### Degree of protection

IP 32 (EN 60529)

#### Connection

Brass, bottom

#### Measuring element

Bourdon tube, Copper alloy  
 $\leq 60$  bar: "C" type tube  
> 60 bar: helical tube

#### movement

Brass

**Dial**  
 NG 40  
 Plastic, white  
 D201  
 black

**Scale**  
 D201

**Pointer**  
 NG 40  
 Plastic, black

**Housing**  
 Sheet steel, black

**push on bezel**  
 NG 40

**window**  
 NG 40  
 Plastic, clipped in

**Options**

- Panel mounting bezel
- 3-hole fixing, panel mounting bezel
- throttle screw
- Reference pointer
- special scales
- other process connections

**Technical Drawings**

**NG 40/50/63 – bottom connection**

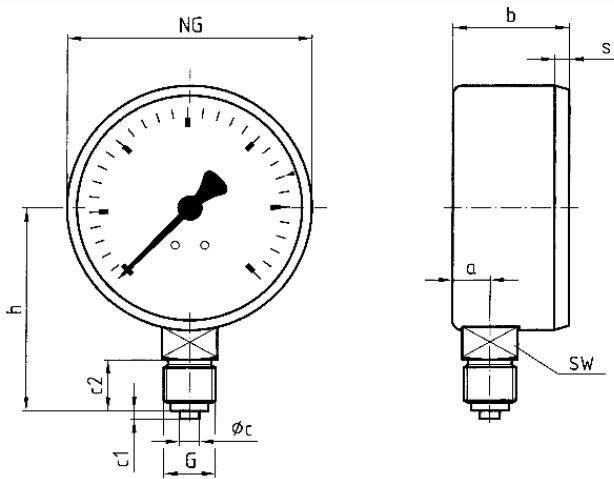

**Dimensions (mm)**

NG	a	b	Øc	c1	c2	G	h	s	SW
40	8,5	23,5	4	2	10	G $\frac{1}{4}$ B	36	3	12
50	10,5	26	5	2	13	G $\frac{1}{4}$ B	45	3,8	14
63	9,5	29,4	5	2	13	G $\frac{1}{4}$ B	51,5	3,7	14

## Versions

Range	Mounting type	Type		Part number
0/25 bar	direct	RF40 D201	<input checked="" type="radio"/>	85017201

- in-stock items
- Non-stock items