



Standard Bourdon tube pressure gauges RF80

Part no. 85155201

Standard Bourdon tube pressure gauges Type D2

benefits

- for pneumatic and heating system applications (NG 40 - 50 - 63)
- for domestic technology and mechanical engineering applications (NG 80 - 100 - 160)
- robust steel housing
- window with adjustable reference pointer (NG 80 - 100)
- with reference pointer on dial (NG 160)
- Accuracy class 1.6
- many customised versions available

Application

For gaseous and liquid media which are not highly viscous, do not crystallise and do not attack copper alloys.
! For measuring gas or vapour, observe the table "Selection Criteria as per EN 837-2"!

Technical Specifications

Type

D2

Nominal size

80

accuracy class (EN 837-1/6)

1.6

ranges (EN 837-1/5)

see ordering table

application area

static load: $\frac{3}{4}$ x full scale value
dynamic load: $\frac{2}{3}$ x full scale value
short-term: Full scale value

Operating temperature range

Medium: max. 60 °C
Ambient: -20/+60 °C

Temperature performance

Indication error when the temperature of the measuring system deviates from the normal temperature of 20 °C:
at rising temperature approx. ± 0.4 %/10 K
falling temperature approx. ± 0.4 %/10 K
of full scale value

Degree of protection

IP 32 (EN 60529)

Connection

Brass, bottom

Measuring element

Bourdon tube, Copper alloy
 ≤ 60 bar: "C" type tube
> 60 bar: helical tube

movement

Brass

Dial
 NG 80
 Plastic, white
 D201
 black

Scale
 D201

Pointer
 NG 80
 Plastic, black

Options

- Panel mounting bezel
- 3-hole fixing, panel mounting bezel
- throttle screw
- Reference pointer
- special scales
- other process connections

Housing
 Sheet steel, black

push on bezel
 NG 80

window
 NG 80
 Plastic, clipped in, with adjustable red reference pointer

Technical Drawings

NG 80/100 – bottom connection

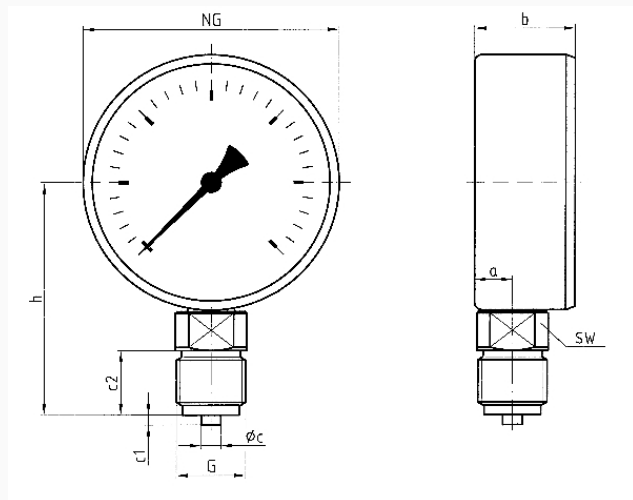

Dimensions (mm)

NG	a	b	Øc	c1	c2	G	h	SW
80	11,7	31	6	3	20	G½B	72	14
100	11	29,5	6	3	20	G½B	82	14

Versions

Range	Mounting type	Type		Part number
-1/+5 bar	direct	RF80 D201	<input checked="" type="radio"/>	85155201

- in-stock items
- Non-stock items