



Standard Bourdon tube pressure gauges RF100

Part no. 85214201

Standard Bourdon tube pressure gauges Type D2

benefits

- for pneumatic and heating system applications (NG 40 - 50 - 63)
- for domestic technology and mechanical engineering applications (NG 80 - 100 - 160)
- robust steel housing
- window with adjustable reference pointer (NG 80 - 100)
- with reference pointer on dial (NG 160)
- Accuracy class 1.6
- many customised versions available

Application

For gaseous and liquid media which are not highly viscous, do not crystallise and do not attack copper alloys.
! For measuring gas or vapour, observe the table "Selection Criteria as per EN 837-2"!

Technical Specifications

Type

D2

Nominal size

100

accuracy class (EN 837-1/6)

1.6

ranges (EN 837-1/5)

see ordering table

application area

static load: $\frac{3}{4}$ x full scale value
dynamic load: $\frac{2}{3}$ x full scale value
short-term: Full scale value

Operating temperature range

Medium: max. 60 °C
Ambient: -20/+60 °C

Temperature performance

Indication error when the temperature of the measuring system deviates from the normal temperature of 20 °C:
at rising temperature approx. ± 0.4 %/10 K
falling temperature approx. ± 0.4 %/10 K
of full scale value

Degree of protection

IP 32 (EN 60529)

Connection

Brass, bottom

Measuring element

Bourdon tube, Copper alloy
 ≤ 60 bar: "C" type tube
> 60 bar: helical tube

movement

Brass

Dial
 NG 100
 Plastic, white
 D201
 black

Scale
 D201

Pointer
 NG 100
 Plastic, black

Housing
 Sheet steel, black

push on bezel
 NG 100

window
 NG 100
 Plastic, clipped in, with adjustable red reference pointer

Options

- Panel mounting bezel
- 3-hole fixing, panel mounting bezel
- throttle screw
- Reference pointer
- special scales
- other process connections

Technical Drawings

NG 80/100 – bottom connection

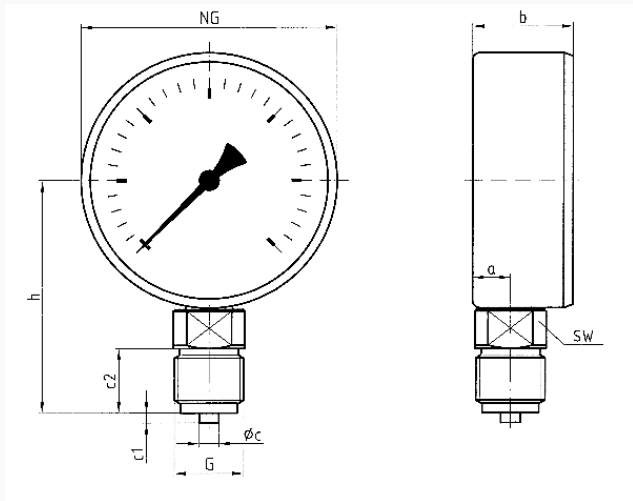

Dimensions (mm)

NG	a	b	Øc	c1	c2	G	h	SW
80	11,7	31	6	3	20	G½B	72	14
100	11	29,5	6	3	20	G½B	82	14

Versions

Range	Mounting type	Type		Part number
0/6 bar	direct	RF100 D201	<input checked="" type="radio"/>	85214201

- in-stock items
- Non-stock items