



Standard Bourdon tube pressure gauges RF100

Part no. 85206211

Standard Bourdon tube pressure gauges Type D2

benefits

- for pneumatic and heating system applications (NG 40 - 50 - 63)
- for domestic technology and mechanical engineering applications (NG 80 - 100 - 160)
- robust steel housing
- window with adjustable reference pointer (NG 80 - 100)
- with reference pointer on dial (NG 160)
- Accuracy class 1.6
- many customised versions available

Application

For gaseous and liquid media which are not highly viscous, do not crystallise and do not attack copper alloys.
! For measuring gas or vapour, observe the table "Selection Criteria as per EN 837-2"!

Technical Specifications

Type
D2

Nominal size
100

accuracy class (EN 837-1/6)
1.6

ranges (EN 837-1/5)
see ordering table

application area
static load: $\frac{3}{4}$ x full scale value
dynamic load: $\frac{2}{3}$ x full scale value
short-term: Full scale value

Operating temperature range
Medium: max. 60 °C
Ambient: -20/+60 °C

Temperature performance

Indication error when the temperature of the measuring system deviates from the normal temperature of 20 °C:
at rising temperature approx. ± 0.4 %/10 K
falling temperature approx. ± 0.4 %/10 K
of full scale value

Degree of protection
IP 32 (EN 60529)

Connection
Brass, centre back

Measuring element
Bourdon tube, Copper alloy
 ≤ 60 bar: "C" type tube
> 60 bar: helical tube

movement
Brass

Dial
NG 100
Plastic, white
D211
black

Scale

D211

push on bezel

NG 100

Pointer

NG 100

Plastic, black

window

NG 100

Plastic, clipped in, with adjustable red reference pointer

Housing

Sheet steel, black

Options

- Panel mounting bezel
- 3-hole fixing, panel mounting bezel
- throttle screw
- Reference pointer
- special scales
- other process connections

Technical Drawings

NG 80/100 – centre back connection

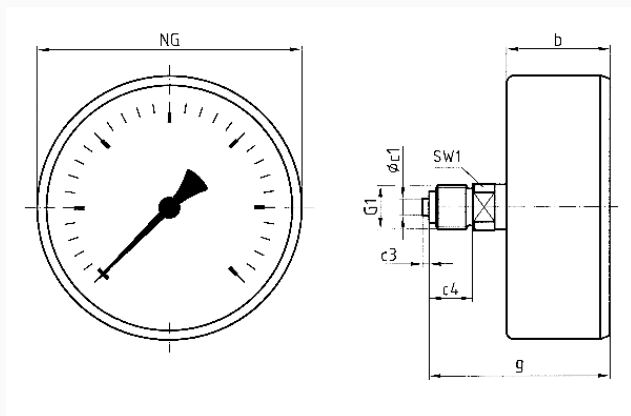

Dimensions (mm)

NG	b	Øc1	c3	c4	g	G1	SW1
80	31	6	2	13	54	G¼B	14
100	29,5	6	2	13	52,5	G¼B	14

Versions

Range	Mounting type	Type	Part number
-1/+9 bar	direct	RF100 D211	85206211

● in-stock items

● Non-stock items