



Standard Bourdon tube pressure gauges RF100

Part no. 85209211

Standard Bourdon tube pressure gauges Type D2

benefits

- for pneumatic and heating system applications (NG 40 - 50 - 63)
- for domestic technology and mechanical engineering applications (NG 80 - 100 - 160)
- robust steel housing
- window with adjustable reference pointer (NG 80 - 100)
- with reference pointer on dial (NG 160)
- Accuracy class 1.6
- many customised versions available

Application

For gaseous and liquid media which are not highly viscous, do not crystallise and do not attack copper alloys.
! For measuring gas or vapour, observe the table "Selection Criteria as per EN 837-2"!

Technical Specifications

Type
D2

Nominal size
100

accuracy class (EN 837-1/6)
1.6

ranges (EN 837-1/5)
see ordering table

application area
static load: $\frac{3}{4}$ x full scale value
dynamic load: $\frac{2}{3}$ x full scale value
short-term: Full scale value

Operating temperature range
Medium: max. 60 °C
Ambient: -20/+60 °C

Temperature performance

Indication error when the temperature of the measuring system deviates from the normal temperature of 20 °C:
at rising temperature approx. ± 0.4 %/10 K
falling temperature approx. ± 0.4 %/10 K
of full scale value

Degree of protection
IP 32 (EN 60529)

Connection
Brass, centre back

Measuring element
Bourdon tube, Copper alloy
 ≤ 60 bar: "C" type tube
> 60 bar: helical tube

movement
Brass

Dial
NG 100
Plastic, white
D211
black

Scale

D211

Pointer

NG 100
Plastic, black

Housing

Sheet steel, black

Options

- Panel mounting bezel
- 3-hole fixing, panel mounting bezel
- throttle screw
- Reference pointer
- special scales
- other process connections

push on bezel

NG 100

window

NG 100
Plastic, clipped in, with adjustable red reference pointer

Technical Drawings

NG 80/100 – centre back connection

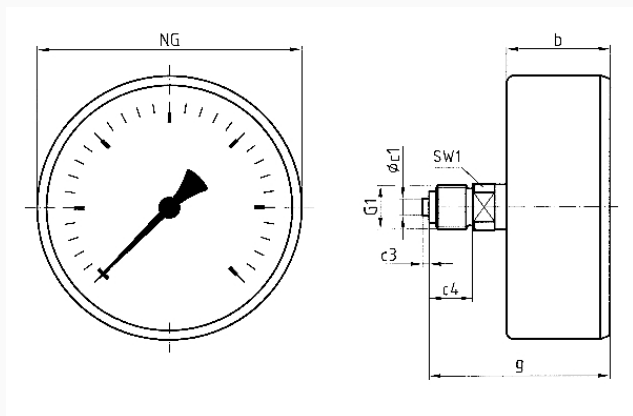

Dimensions (mm)

NG	b	Øc1	c3	c4	g	G1	SW1
80	31	6	2	13	54	G¼B	14
100	29,5	6	2	13	52,5	G¼B	14

Versions

Range	Mounting type	Type	Part number
0/0.6 bar	direct	RF100 D211	85209211

- in-stock items
- Non-stock items