



## Standard Bourdon tube pressure gauges RF100

Part no. 85213211

Standard Bourdon tube pressure gauges Type D2

### benefits

- for pneumatic and heating system applications (NG 40 - 50 - 63)
- for domestic technology and mechanical engineering applications (NG 80 - 100 - 160)
- robust steel housing
- window with adjustable reference pointer (NG 80 - 100)
- with reference pointer on dial (NG 160)
- Accuracy class 1.6
- many customised versions available

### Application

For gaseous and liquid media which are not highly viscous, do not crystallise and do not attack copper alloys.  
! For measuring gas or vapour, observe the table "Selection Criteria as per EN 837-2"!

### Technical Specifications

**Type**  
D2

**Nominal size**  
100

**accuracy class (EN 837-1/6)**  
1.6

**ranges (EN 837-1/5)**  
see ordering table

**application area**  
static load:  $\frac{3}{4}$  x full scale value  
dynamic load:  $\frac{2}{3}$  x full scale value  
short-term: Full scale value

**Operating temperature range**  
Medium: max. 60 °C  
Ambient: -20/+60 °C

### Temperature performance

Indication error when the temperature of the measuring system deviates from the normal temperature of 20 °C:  
at rising temperature approx.  $\pm 0.4$  %/10 K  
falling temperature approx.  $\pm 0.4$  %/10 K  
of full scale value

**Degree of protection**  
IP 32 (EN 60529)

**Connection**  
Brass, centre back

**Measuring element**  
Bourdon tube, Copper alloy  
 $\leq 60$  bar: "C" type tube  
> 60 bar: helical tube

**movement**  
Brass

**Dial**  
NG 100  
Plastic, white  
D211  
black

**Scale**

D211

**push on bezel**

NG 100

**Pointer**

NG 100

Plastic, black

**window**

NG 100

Plastic, clipped in, with adjustable red reference pointer

**Housing**

Sheet steel, black

**Options**

- Panel mounting bezel
- 3-hole fixing, panel mounting bezel
- throttle screw
- Reference pointer
- special scales
- other process connections

**Technical Drawings**

**NG 80/100 – centre back connection**

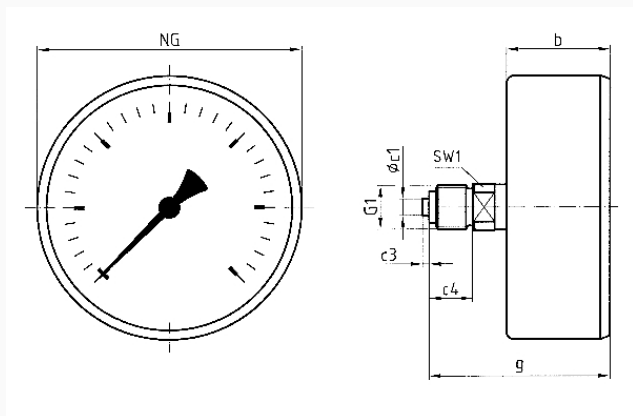

**Dimensions (mm)**

NG	b	∅c1	c3	c4	g	G1	SW1
80	31	6	2	13	54	G <sup>1</sup> / <sub>4</sub> B	14
100	29,5	6	2	13	52,5	G <sup>1</sup> / <sub>4</sub> B	14

**Versions**

Range	Mounting type	Type	Part number
0/4 bar	direct	RF100 D211	85213211

● in-stock items

● Non-stock items