



Standard Bourdon tube pressure gauges RF50

Part no. 85071251

Standard Bourdon tube pressure gauges Type D2

benefits

- for pneumatic and heating system applications (NG 40 - 50 - 63)
- for domestic technology and mechanical engineering applications (NG 80 - 100 - 160)
- robust steel housing
- window with adjustable reference pointer (NG 80 - 100)
- with reference pointer on dial (NG 160)
- Accuracy class 1.6
- many customised versions available

Application

For gaseous and liquid media which are not highly viscous, do not crystallise and do not attack copper alloys.
! For measuring gas or vapour, observe the table "Selection Criteria as per EN 837-2"!

Technical Specifications

Type
D2

Nominal size
50

accuracy class (EN 837-1/6)
1.6

ranges (EN 837-1/5)
see ordering table

application area
static load: $\frac{3}{4}$ x full scale value
dynamic load: $\frac{2}{3}$ x full scale value
short-term: Full scale value

Operating temperature range
Medium: max. 60 °C
Ambient: -20/+60 °C

Temperature performance

Indication error when the temperature of the measuring system deviates from the normal temperature of 20 °C:
at rising temperature approx. ± 0.4 %/10 K
falling temperature approx. ± 0.4 %/10 K
of full scale value

Degree of protection
IP 32 (EN 60529)

Connection
Brass, centre back

Measuring element
Bourdon tube, Copper alloy
 ≤ 60 bar: "C" type tube
 > 60 bar: helical tube

movement
Brass

Dial
NG 50
Plastic, white
D251

Scale

D251
dual scale, bar outer, black – psi inner, red

Pointer

NG 50

Housing

Sheet steel, black

push on bezel

NG 50

window

NG 50
Plastic, clipped in

Options

- Panel mounting bezel
- 3-hole fixing, panel mounting bezel
- throttle screw
- Reference pointer
- special scales
- other process connections

Technical Drawings

NG 40/50/63 – centre back connection, panel mounting bezel with clamp fixing

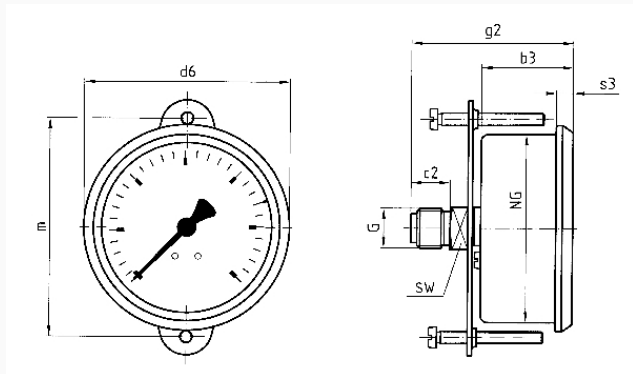

Dimensions (mm)

NG	b3	c2	d6	g2	G	m	s3	SW
40	28	10	44	46,6	G $\frac{1}{8}$ B	50	5,2	12
50	30,3	13	54	51,3	G $\frac{1}{4}$ B	45	5,4	14
63	30,3	13	67,8	53,3	G $\frac{1}{4}$ B	51,5	5,6	14

Versions

Range	Mounting type	Type	Part number
0/160 bar	Panel mounting bezel, with clamp fixing	RF50 D251	85071251

- in-stock items
- Non-stock items