



## Standard Bourdon tube pressure gauges RF63

Part no. 85101251

Standard Bourdon tube pressure gauges Type D2

### benefits

- for pneumatic and heating system applications (NG 40 - 50 - 63)
- for domestic technology and mechanical engineering applications (NG 80 - 100 - 160)
- robust steel housing
- window with adjustable reference pointer (NG 80 - 100)
- with reference pointer on dial (NG 160)
- Accuracy class 1.6
- many customised versions available

### Application

For gaseous and liquid media which are not highly viscous, do not crystallise and do not attack copper alloys.  
! For measuring gas or vapour, observe the table "Selection Criteria as per EN 837-2"!

### Technical Specifications

**Type**  
D2

**Nominal size**  
63

**accuracy class (EN 837-1/6)**  
1.6

**ranges (EN 837-1/5)**  
see ordering table

**application area**  
static load:  $\frac{3}{4}$  x full scale value  
dynamic load:  $\frac{2}{3}$  x full scale value  
short-term: Full scale value

**Operating temperature range**  
Medium: max. 60 °C  
Ambient: -20/+60 °C

### Temperature performance

Indication error when the temperature of the measuring system deviates from the normal temperature of 20 °C:  
at rising temperature approx.  $\pm 0.4$  %/10 K  
falling temperature approx.  $\pm 0.4$  %/10 K  
of full scale value

**Degree of protection**  
IP 32 (EN 60529)

**Connection**  
Brass, centre back

**Measuring element**  
Bourdon tube, Copper alloy  
 $\leq 60$  bar: "C" type tube  
 $> 60$  bar: helical tube

**movement**  
Brass

**Dial**  
NG 63  
Plastic, white  
D251

**Scale**

D251  
dual scale, bar outer, black – psi inner, red

**Pointer**

NG 63

**Housing**

Sheet steel, black

**push on bezel**

NG 63

**window**

NG 63  
Plastic, clipped in

**Options**

- Panel mounting bezel
- 3-hole fixing, panel mounting bezel
- throttle screw
- Reference pointer
- special scales
- other process connections

**Technical Drawings**

**NG 40/50/63 – centre back connection, panel mounting bezel with clamp fixing**

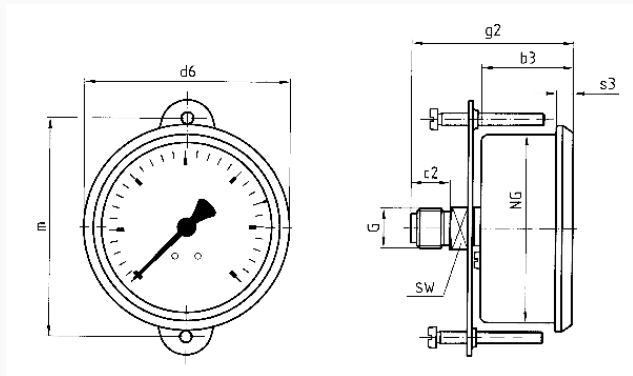

**Dimensions (mm)**

NG	b3	c2	d6	g2	G	m	s3	SW
40	28	10	44	46,6	G $\frac{1}{8}$ B	50	5,2	12
50	30,3	13	54	51,3	G $\frac{1}{4}$ B	45	5,4	14
63	30,3	13	67,8	53,3	G $\frac{1}{4}$ B	51,5	5,6	14

**Versions**

Range	Mounting type	Type	Part number
-1/+0 bar	Panel mounting bezel, with clamp fixing	RF63 D251	85101251

- in-stock items
- Non-stock items