



## Bourdon tube pressure gauges for chemical applications RF100Ch

Part no. 85210452

Bourdon tube pressure gauges for chemical applications Type D4

### benefits

- for chemical and process engineering applications
- measuring system fully welded to housing
- extremely robust design
- for temperatures of the medium of up to 200 °C
- tightness-tested with helium
- DNV- and GOSSTANDART-certified
- Ex version (optional)

### Application

For corrosive gaseous and liquid media which are not highly viscous and do not crystallise; suitable for corrosive environments.  
! For measuring gas or vapour, observe the table "Selection Criteria as per EN 837-2"!

### Technical Specifications

**Type**  
D4

**Nominal size**  
100

**accuracy class (EN 837-1/6)**  
1.0

**ranges (EN 837-1/5)**  
see ordering table

**Application area NG100/160**  
 ≤ 600 bar: Full scale value  
 > 600 bar: ¾ x full scale value  
 ≤ 600 bar: 0.9 x full scale value  
 > 600 bar: ⅔ x full scale value  
 ≤ 600 bar: 1.3 x full scale value  
 > 600 bar: Full scale value

### Operating temperature range

Medium: max. 200 °C  
Ambient: -20/+60 °C

### Temperature performance

Indication error when the temperature of the measuring system deviates from the normal temperature of 20 °C:  
 at rising temperature approx. ± 0.4 %/10 K  
 falling temperature approx. ± 0.4 %/10 K  
 of full scale value

### Degree of protection

IP 54 (EN 60529) with housing vent (≤ 25 bar)

### Connection

Stainless steel 316 L, bottom back  
G½B, SW22 (EN 837-1/7.3)

**Measuring element**

Bourdon tube, stainless steel 316 Ti/316 L  
 ≤ 60 bar: "C" type tube  
 > 60 bar: helical tube  
 tightness-tested with helium

**movement**

Stainless steel

**Dial**

Aluminium, white  
 Scaling: black

**Pointer**

Aluminium, black

**Housing**

Stainless steel 304, with blow-out

**bayonet bezel**

Stainless steel 304

**window**

Laminated safety glass

**Options**

- back flange
- Panel mounting bezel
- 3-hole fixing, panel mounting bezel
- Ex version
- Crimped bezel, polished
- Electrical contacts
- special scales
- other process connections

**Technical Drawings**

**bottom back connection, panel mounting bezel with clamp fixing**

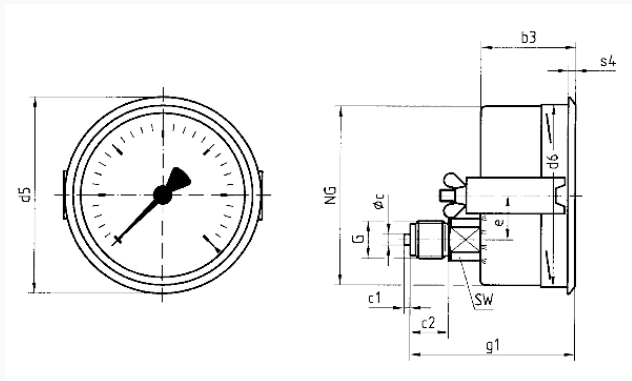

**Dimensions (mm)**

NG	b3	∅c	c1	c2	d5	d6	e	G	g1	s4	SW
100	49	6	3	20	107	101	34,5	G½B	83	4	22
160	52	6	3	20	167	161	34,5	G½B	86	4,5	22

## Versions

Range	Mounting type	Type	Part number
0/1 bar	Panel mounting bezel, with clamp fixing	RF100Ch D452	85210452

- in-stock items
- Non-stock items