



Stainless steel Bourdon tube pressure gauges RF40E

Part no. 85013302

Stainless steel Bourdon tube pressure gauges Type D3

benefits

- extremely compact design
- wetted parts and movement made of stainless steel
- Pressure connection welded to housing
- optional for control cabinet mounting
- tightness-tested with helium
- GOSSTANDART-certified

Application

For corrosive gaseous and liquid media which are not highly viscous and do not crystallise.

! For measuring gas or vapour, observe the table "Selection Criteria as per EN 837-2" (see appendix)!

Technical Specifications

Type

D3

Nominal size

40

accuracy class (EN 837-1/6)

2.5

ranges (EN 837-1/5)

see ordering table

application area

static load: $\frac{3}{4}$ x full scale value
dynamic load: $\frac{2}{3}$ x full scale value
short-term: Full scale value

Operating temperature range

Medium: max. 100 °C
Ambient: -20/+60 °C

Temperature performance

Indication error when the temperature of the measuring system deviates from the normal temperature of 20 °C:
at rising temperature approx. ± 0.4 %/10 K
falling temperature approx. ± 0.4 %/10 K
of full scale value

Degree of protection

IP 32 (EN 60529)

Connection

Stainless steel 316 L, bottom

Measuring element

Bourdon tube, Stainless steel 316 L
 ≤ 60 bar: "C" type tube
> 60 bar: helical tube
tightness-tested with helium

movement

Stainless steel

Dial
Aluminium, white
Scaling: black

Pointer
Aluminium, black

Housing
Stainless steel 304

window
Plastic, clipped in

Options

- 3-hole fixing, panel mounting bezel
- special scales
- other process connections
- oil- and grease-free version

Technical Drawings

NG 40 – bottom connection G $\frac{1}{8}$

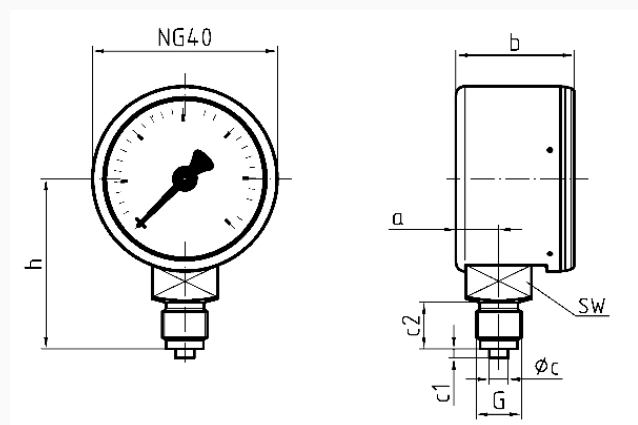

Dimensions (mm)

NG	a	b	Øc	c1	c2	G	h	SW
40	9,2	25,5	4	2	10	G $\frac{1}{8}$ B	36,5	14

Versions

Range	Mounting type	Type	Part number
0/4 bar	direct	RF40E D302	85013302

- in-stock items
- Non-stock items