



Bourdon tube pressure gauge RF50GT

Part no. 85066302GT

Standard Bourdon tube pressure gauges for gas applications Type D3

benefits

- Version safety pressure gauge S2 as per EN 837-1
- dual scale for measurement of different media (option)
- rear blow-out
- many customised versions available

Application

For gaseous and liquid media which are not highly viscous and do not crystallise. Specially designed for gas technology devices, fittings and installations.

! For measuring gas or vapour, these gauges must be used in accordance with the table "Selection Criteria as per EN 837-2" (see appendix)!

Technical Specifications

Type
D3

Nominal size
50

Version
EN 837-1-S2

accuracy class (EN 837-1/6)
1.6

ranges (EN 837-1/5)
see ordering table

application area
static load: $\frac{3}{4}$ x full scale value
dynamic load: $\frac{2}{3}$ x full scale value
short-term: Full scale value

Operating temperature range

Medium: max. 60 °C
Ambient: -20/+60 °C

Temperature performance

Indication error when the temperature of the measuring system deviates from the normal temperature of 20 °C:
at rising temperature approx. ± 0.4 %/10 K
falling temperature approx. ± 0.4 %/10 K
of full scale value

Degree of protection

IP 32 (EN 60529)

Connection

D302
stainless steel 316 Ti/316 L
bottom

Measuring element

Bourdon tube
D302
stainless steel 316 Ti/316 L
≤ 40 bar: "C" type tube
> 40 bar: helical tube

movement

Brass

Dial

Aluminium, white
Scaling: black

Options

- wetted parts stainless steel
- wetted parts oil-free and grease-free
- Helium leak test
- throttle screw
- special scales
- other connection threads

Pointer

Aluminium, black

Housing

Stainless steel 304, with rear blow-out

window

Plastic, snapped in

Technical Drawings

Bottom connection

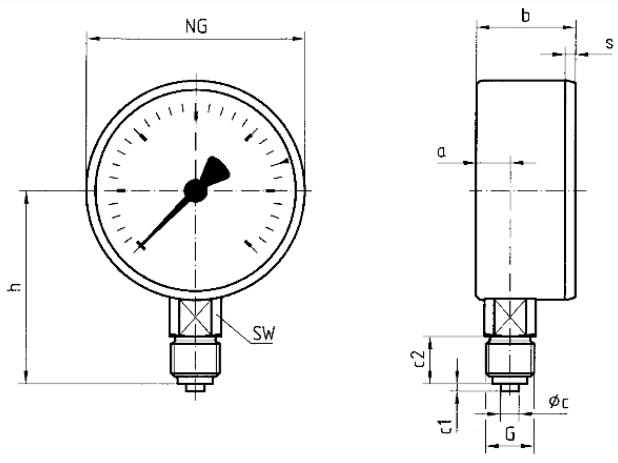

Dimensions (mm)

NG	a	b	øc	c1	c2	G	h	s	SW
40	8,2	23,5	4	2	10	G1/8B	36	3	12
50	10,5	29	5	2	13	G1/4B	46	3,8	14
63	11	29,5	5	2	13	G1/4B	53	3,7	14

Versions

Range	Mounting type	Type	Part number
0/16 bar	direct	RF50GT D302	85066302GT

- in-stock items
- Non-stock items