



## Bourdon tube pressure gauge RF63GT

Part no. 85113302GT

Standard Bourdon tube pressure gauges for gas applications Type D3

### benefits

- Version safety pressure gauge S2 as per EN 837-1
- dual scale for measurement of different media (option)
- rear blow-out
- many customised versions available

### Application

For gaseous and liquid media which are not highly viscous and do not crystallise. Specially designed for gas technology devices, fittings and installations.

! For measuring gas or vapour, these gauges must be used in accordance with the table "Selection Criteria as per EN 837-2" (see appendix)!

### Technical Specifications

**Type**  
D3

**Nominal size**  
63

**Version**  
EN 837-1-S2

**accuracy class (EN 837-1/6)**  
1.6

**ranges (EN 837-1/5)**  
see ordering table

**application area**  
static load:  $\frac{3}{4}$  x full scale value  
dynamic load:  $\frac{2}{3}$  x full scale value  
short-term: Full scale value

### Operating temperature range

Medium: max. 60 °C  
Ambient: -20/+60 °C

### Temperature performance

Indication error when the temperature of the measuring system deviates from the normal temperature of 20 °C:  
at rising temperature approx.  $\pm 0.4$  %/10 K  
falling temperature approx.  $\pm 0.4$  %/10 K  
of full scale value

### Degree of protection

IP 32 (EN 60529)

### Connection

D302  
stainless steel 316 Ti/316 L  
bottom

**Measuring element**

Bourdon tube  
D302  
stainless steel 316 Ti/316 L  
≤ 40 bar: "C" type tube  
> 40 bar: helical tube

**movement**

Brass

**Dial**

Aluminium, white  
Scaling: black

**Options**

- wetted parts stainless steel
- wetted parts oil-free and grease-free
- Helium leak test
- throttle screw
- special scales
- other connection threads

**Pointer**

Aluminium, black

**Housing**

Stainless steel 304, with rear blow-out

**window**

Plastic, snapped in

**Technical Drawings**

**Bottom connection**

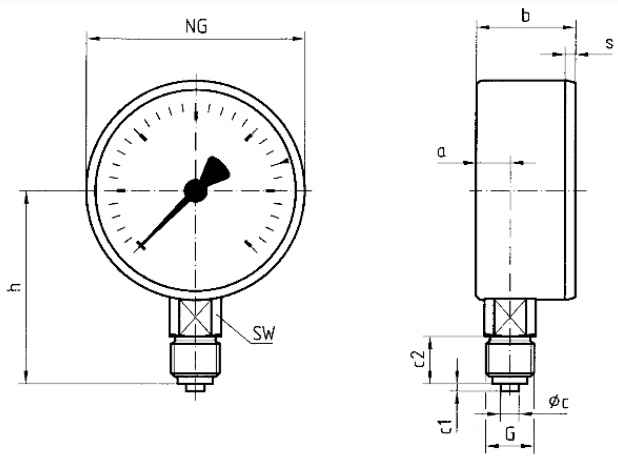

**Dimensions (mm)**

NG	a	b	øc	c1	c2	G	h	s	SW
40	8,2	23,5	4	2	10	G1/8B	36	3	12
50	10,5	29	5	2	13	G1/4B	46	3,8	14
63	11	29,5	5	2	13	G1/4B	53	3,7	14

## Versions

Range	Mounting type	Type		Part number
0/4 bar	direct	RF63GT D302	<input type="radio"/>	85113302GT

- in-stock items
- Non-stock items