

## Bourdon tube pressure gauge RF63GT

Part no. 85117311GT

Standard Bourdon tube pressure gauges for gas applications Type D3

### benefits

- Version safety pressure gauge S2 as per EN 837-1
- dual scale for measurement of different media (option)
- rear blow-out
- many customised versions available

### Application

For gaseous and liquid media which are not highly viscous and do not crystallise. Specially designed for gas technology devices, fittings and installations.

! For measuring gas or vapour, these gauges must be used in accordance with the table "Selection Criteria as per EN 837-2" (see appendix)!

### Technical Specifications

**Type**  
D3

**Nominal size**  
63

**Version**  
EN 837-1-S2

**accuracy class (EN 837-1/6)**  
1.6

**ranges (EN 837-1/5)**  
see ordering table

**application area**  
static load:  $\frac{3}{4}$  x full scale value  
dynamic load:  $\frac{2}{3}$  x full scale value  
short-term: Full scale value

### Operating temperature range

Medium: max. 60 °C  
Ambient: -20/+60 °C

### Temperature performance

Indication error when the temperature of the measuring system deviates from the normal temperature of 20 °C:  
at rising temperature approx.  $\pm 0.4$  %/10 K  
falling temperature approx.  $\pm 0.4$  %/10 K  
of full scale value

### Degree of protection

IP 32 (EN 60529)

### Connection

D311  
Brass  
centre back

**Measuring element**

Bourdon tube  
D311  
Copper alloy  
≤ 40 bar: "C" type tube  
> 40 bar: helical tube

**movement**

Brass

**Dial**

Aluminium, white  
Scaling: black

**Options**

- wetted parts stainless steel
- wetted parts oil-free and grease-free
- Helium leak test
- throttle screw
- special scales
- other connection threads

**Pointer**

Aluminium, black

**Housing**

Stainless steel 304, with rear blow-out

**window**

Plastic, snapped in

**Technical Drawings**

**Centre back connection**

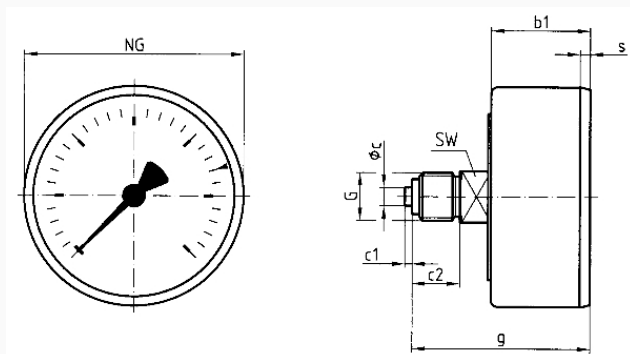

**Dimensions (mm)**

NG	b1	∅c	c1	c2	G	g	s	SW
50	26	5	2	13	G $\frac{1}{4}$ B	47	3,8	14
63	29,5	5	2	13	G $\frac{1}{4}$ B	50,5	3,7	14

## Versions

Range	Mounting type	Type	Part number
0/25 bar	direct	RF63GT D311	85117311GT

- in-stock items
- Non-stock items