



Bourdon tube pressure gauges for industrial applications RF100I

Part no. 85314431

Bourdon tube pressure gauges for industrial applications Type D4

benefits

- for machine and plant engineering
- robust, stainless steel housing with bayonet bezel
- can be equipped with electrical contact
- DNV-GL- and GOSSTANDART-certified

Application

For gaseous and liquid media which are not highly viscous, do not crystallise and do not attack copper alloys. For high accuracy and rough application conditions.

! For measuring gas or vapour, observe the table "Selection Criteria as per EN 837-2" (see appendix)!

Technical Specifications

Type

D4

Nominal size

100

accuracy class (EN 837-1/6)

1.0

ranges (EN 837-1/5)

see ordering table

application area

- ≤ 600 bar: Full scale value
- > 600 bar: ¾ x full scale value
- ≤ 600 bar: 0.9 x full scale value
- > 600 bar: ⅔ x full scale value
- ≤ 600 bar: 1.3 x full scale value
- > 600 bar: Full scale value

Operating temperature range

Medium: max. 60 °C
Ambient: -20/+60 °C

Temperature performance

Indication error when the temperature of the measuring system deviates from the normal temperature of 20 °C:
at rising temperature approx. ± 0.4 %/10 K
falling temperature approx. ± 0.4 %/10 K
of full scale value

Degree of protection

IP 54 (EN 60529)

Connection

Brass, bottom back

Measuring element

Bourdon tube
≤ 60 bar: "C" type tube, Copper alloy
> 60 bar: helical tube, stainless steel 316 Ti/316 L

movement

Brass

Dial

Aluminium, white
Scaling: black

Pointer

Aluminium, black

bayonet bezel

Stainless steel 304

Housing

Stainless steel 304, with blow-out

window

Instrument glass

Options

- back flange
- Panel mounting bezel
- 3-hole fixing, panel mounting bezel
- laminated safety glass window
- throttle screw
- Reference pointer
- Electrical contacts
- special scales
- other process connections

Technical Drawings

bottom back connection, 3-hole fixing, panel mounting bezel

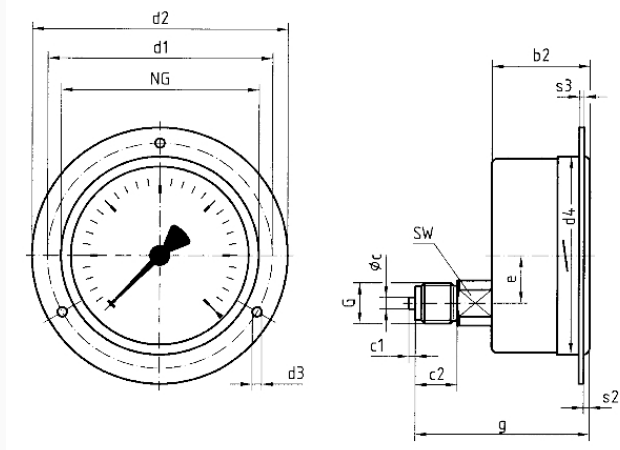

Dimensions (mm)

NG	b2	∅c	c1	c2	d1*	d2	d3*	d4	e	G	g	s2	s3	SW
100	49	6	3	20	116	132	4,8	104	26,5	G½B	81	4	2	22
160	50	6	3	20	178	196	5,8	164	26,5	G½B	82	4	2	22
250	-	6	3	20	270	285	5,8	-	-	G½B	-	-	-	22

* Dimensions for NG 100 according to DIN 16064

Versions

Range	Mounting type	Type		Part number
0/6 bar	3-hole fixing, panel mounting bezel	RF100I D431	●	85314431

- in-stock items
- Non-stock items