



Bourdon tube pressure gauges Process Gauge RF130PG

Part no. 87914101

Standard Bourdon tube pressure gauges Process Gauges Type D1

benefits

- extremely robust pressure gauge for offshore and onshore applications
- glass-fibre reinforced safety housing with solid baffle wall and blow-out
- integrated pressure compensation diaphragm
- tightness-tested with helium
- GOSSTANDART-certified

Application

For corrosive gaseous and liquid media which are not highly viscous and do not crystallise. Specially suitable for the oil and chemical industries.

Technical Specifications

Type

D1

Nominal size

4.5

accuracy class (ASME B 40.100)

Grade 2A (correspond to an accuracy of 0.5 %)

ranges (EN 837-1/5)

see ordering table

application area

static load: Full scale value
dynamic load: 0.9 x full scale value
short-term: 1.3 x full scale value

Operating temperature range

Medium: max. 100 °C
Ambient: -40/+65 °C

Temperature performance

Indication error when the temperature of the measuring system deviates from the normal temperature of 20 °C:
at rising temperature approx. $\pm 0.4 \text{ \%}/10 \text{ K}$
falling temperature approx. $\pm 0.4 \text{ \%}/10 \text{ K}$
of full scale value

Degree of protection

IP 67 (EN 60529)

Connection

Brass
D101
bottom

Measuring element

Bourdon tube, stainless steel 316 Ti/316 L
 $\leq 60 \text{ bar}$: "C" type tube
 $> 60 \text{ bar}$: helical tube
tightness-tested with helium

movement

Stainless steel

Dial
Aluminium, white
Scaling: black

Pointer
micro-adjustable pointer
Brass, black

Housing
PP-GF20, black
with solid baffle wall and blow-out,
Integrated back flange

Screw type bezel
PP-GF20, black Internal

window
Plastic (PMMA)

Options

- Glycerine filling (type D 6)
- Silicone oil filling (type D 6)
- Measuring system copper alloy (type 1x1)
- Measuring system Monel (type 1x3)
- laminated safety glass window
- Reference pointer
- Maximum pointer
- Electrical contacts
- special scales
- other process connections

Technical Drawings

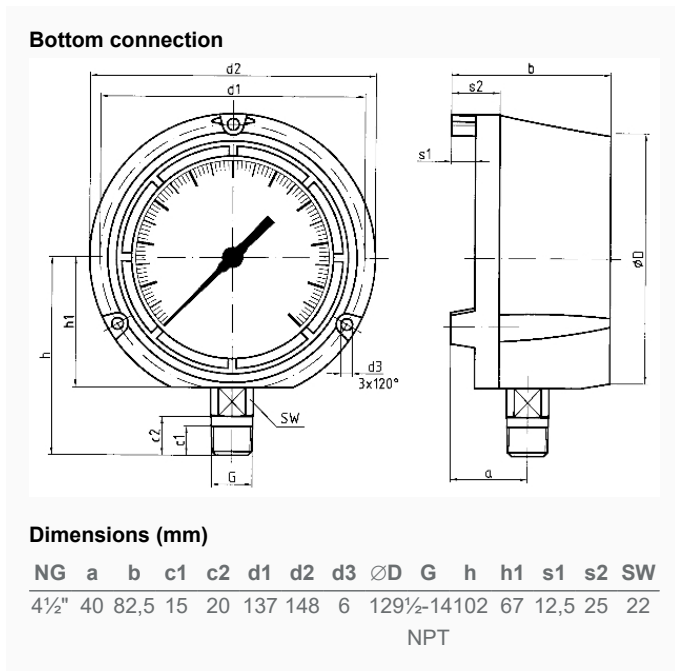

Versions

Range	Mounting type	Type	Part number
0/6 bar	back flange	RF130PG D101	87914101

- in-stock items
- Non-stock items