



## Bourdon tube pressure gauges Process Gauge RF130PG

Part no. 87906102

Standard Bourdon tube pressure gauges Process Gauges Type D1

### benefits

- extremely robust pressure gauge for offshore and onshore applications
- glass-fibre reinforced safety housing with solid baffle wall and blow-out
- integrated pressure compensation diaphragm
- tightness-tested with helium
- GOSSTANDART-certified

### Application

For corrosive gaseous and liquid media which are not highly viscous and do not crystallise. Specially suitable for the oil and chemical industries.

### Technical Specifications

#### Type

D1

#### Nominal size

4.5

#### accuracy class (ASME B 40.100)

Grade 2A (correspond to an accuracy of 0.5 %)

#### ranges (EN 837-1/5)

see ordering table

#### application area

static load: Full scale value  
dynamic load: 0.9 x full scale value  
short-term: 1.3 x full scale value

#### Operating temperature range

Medium: max. 100 °C  
Ambient: -40/+65 °C

#### Temperature performance

Indication error when the temperature of the measuring system deviates from the normal temperature of 20 °C:  
at rising temperature approx.  $\pm 0.4 \%$ /10 K  
falling temperature approx.  $\pm 0.4 \%$ /10 K  
of full scale value

#### Degree of protection

IP 67 (EN 60529)

#### Connection

Stainless steel 316 L  
D102  
bottom

#### Measuring element

Bourdon tube, stainless steel 316 Ti/316 L  
 $\leq 60$  bar: "C" type tube  
> 60 bar: helical tube  
tightness-tested with helium

#### movement

Stainless steel

**Dial**

Aluminium, white  
Scaling: black

**Pointer**

micro-adjustable pointer  
Brass, black

**Housing**

PP-GF20, black  
with solid baffle wall and blow-out,  
Integrated back flange

**Screw type bezel**

PP-GF20, black Internal

**window**

Plastic (PMMA)

**Options**

- Glycerine filling (type D 6)
- Silicone oil filling (type D 6)
- Measuring system copper alloy (type 1x1)
- Measuring system Monel (type 1x3)
- laminated safety glass window
- Reference pointer
- Maximum pointer
- Electrical contacts
- special scales
- other process connections

**Technical Drawings**

**Bottom connection**

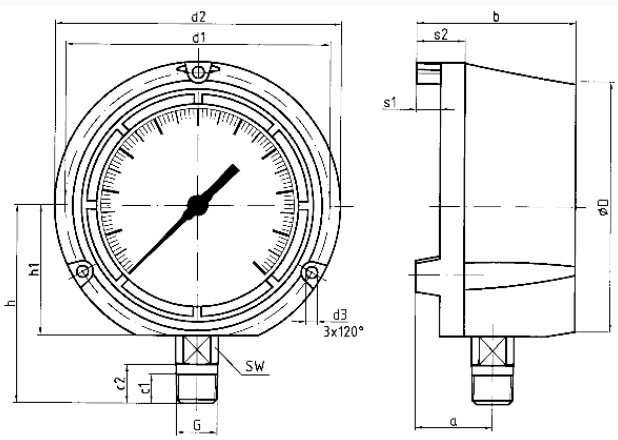

**Dimensions (mm)**

NG	a	b	c1	c2	d1	d2	d3	ØD	G	h	h1	s1	s2	SW
4½"	40	82,5	15	20	137	148	6	129½-14102		67	12,5	25	22	
NPT														

## Versions

Range	Mounting type	Type	Part number
-1/+9 bar	back flange	RF130PG D102	87906102

- in-stock items
- Non-stock items