

## Bourdon tube pressure gauge RF63RG

Part no. 87005302

Bourdon tube pressure gauge for ultra-pure gas applications type D3

### benefits

- wetted parts specially cleaned, flushed and electropolished
- tightness-tested with helium
- rear blow-out
- versatile connection technology
- GOSSTANDART-certified

### Application

Designed for highly demanding applications in terms of surface quality and purity of the wetted parts, particularly for measuring ultra-pure gases. ! For measuring gas or vapour, observe the table "Selection Criteria as per EN 837-2" (see appendix)!

### Technical Specifications

#### Type

D3

#### Nominal size

63

#### accuracy class (EN 837-1/6)

1.6

#### ranges (EN 837-1/5)

see ordering table

#### Calibration medium

Nitrogen or dried air

#### application area

static load:  $\frac{3}{4}$  x full scale value  
dynamic load:  $\frac{2}{3}$  x full scale value  
short-term: Full scale value

#### Operating temperature range

Medium: max. 150 °C

Ambient: -20/+60 °C

#### Temperature performance

Indication error when the temperature of the measuring system deviates from the normal temperature of 20 °C:  
at rising temperature approx.  $\pm 0.4$  %/10 K  
falling temperature approx.  $\pm 0.4$  %/10 K  
of full scale value

#### Degree of protection

IP 32 (EN 60529)

#### Connection

stainless steel 316 Ti/316 L, bottom  
 $\frac{1}{4}$ -18 NPT

**Measuring element**

Bourdon tube, stainless steel 316 Ti/316 L  
 ≤ 60 bar: "C" type tube  
 > 60 bar: helical tube  
 tightness-tested with helium,  
 leak rate ≤ 10<sup>-9</sup> mbar x l/s

**wetted parts**

Connection, Measuring element  
 stainless steel 316 Ti/316 L  
 cleaned, flushed with nitrogen, electropolished, surface roughness  
 ≤ R<sub>a</sub> 0.6 µm

**movement**

Stainless steel

**Dial**

Aluminium, white  
 Scaling: black  
 label: ultra-pure gas

**Pointer**

Aluminium, black

**Housing**

Stainless steel 304, with rear blow-out

**push on bezel**

Stainless steel 304, bare metal surface

**window**

Plastic

**Options**

- surface roughness R<sub>a</sub> 0.4 µm
- Housing polished
- Push on bezel polished
- Electrical contacts
- NG 50
- special scales
- other process connections

**Technical Drawings**

**Bottom connection, 1/4-18 NPT**

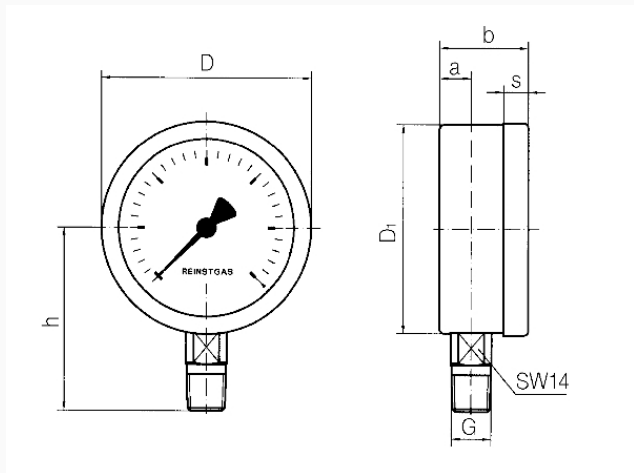

**Dimensions (mm)**

NG	a	b	D	D1	G	h	s
63	9	28	63	62	1/4-18 NPT	54	8

## Versions

Range	Mounting type	Type		Part number
-1/+5 bar	direct	RF63RG D302	●	87005302

- in-stock items
- Non-stock items