



Bourdon tube pressure gauge RF63RG

Part no. 87019302

Bourdon tube pressure gauge for ultra-pure gas applications type D3

benefits

- wetted parts specially cleaned, flushed and electropolished
- tightness-tested with helium
- rear blow-out
- versatile connection technology
- GOSSTANDART-certified

Application

Designed for highly demanding applications in terms of surface quality and purity of the wetted parts, particularly for measuring ultra-pure gases. ! For measuring gas or vapour, observe the table "Selection Criteria as per EN 837-2" (see appendix)!

Technical Specifications

Type

D3

Nominal size

63

accuracy class (EN 837-1/6)

1.6

ranges (EN 837-1/5)

see ordering table

Calibration medium

Nitrogen or dried air

application area

static load: $\frac{3}{4}$ x full scale value
dynamic load: $\frac{2}{3}$ x full scale value
short-term: Full scale value

Operating temperature range

Medium: max. 150 °C

Ambient: -20/+60 °C

Temperature performance

Indication error when the temperature of the measuring system deviates from the normal temperature of 20 °C:
at rising temperature approx. ± 0.4 %/10 K
falling temperature approx. ± 0.4 %/10 K
of full scale value

Degree of protection

IP 32 (EN 60529)

Connection

stainless steel 316 Ti/316 L, bottom
 $\frac{1}{4}$ -18 NPT

Measuring element

Bourdon tube, stainless steel 316 Ti/316 L
 ≤ 60 bar: "C" type tube
 > 60 bar: helical tube
 tightness-tested with helium,
 leak rate ≤ 10⁻⁹ mbar x l/s

wetted parts

Connection, Measuring element
 stainless steel 316 Ti/316 L
 cleaned, flushed with nitrogen, electropolished, surface roughness
 ≤ R_a 0.6 µm

movement

Stainless steel

Dial

Aluminium, white
 Scaling: black
 label: ultra-pure gas

Pointer

Aluminium, black

Housing

Stainless steel 304, with rear blow-out

push on bezel

Stainless steel 304, bare metal surface

window

Plastic

Options

- surface roughness R_a 0.4 µm
- Housing polished
- Push on bezel polished
- Electrical contacts
- NG 50
- special scales
- other process connections

Technical Drawings

Bottom connection, 1/4-18 NPT

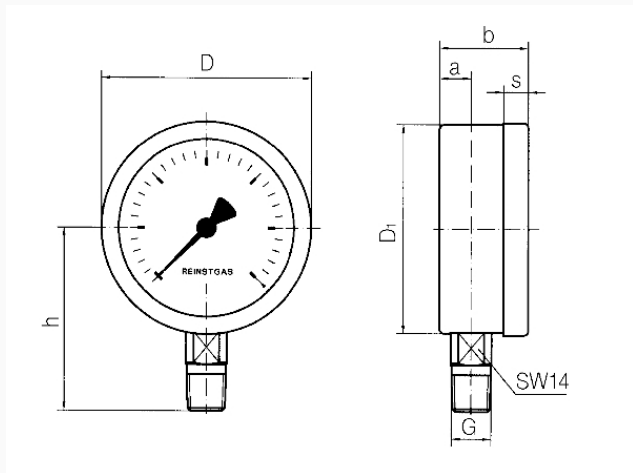

Dimensions (mm)

NG	a	b	D	D1	G	h	s
63	9	28	63	62	1/4-18 NPT	54	8

Versions

Range	Mounting type	Type	Part number
0/60 bar	direct	RF63RG D302	87019302

- in-stock items
- Non-stock items